

EnGenius®

Digital
Long Range Industrial Cordless
Phone Systems

DuraFon PRO & DuraWalkie



User's Manual

Table of Contents

Safety Instructions	4
General Safety Instructions.....	4
Product Safety Instructions.....	5
Battery Safety Instructions.....	7
Regulatory Information	8
Congratulations	10
Equipment Checklist	11
Handset Illustration	13
Handset Features	14
Basic Handset Features.....	14
Additional Handset Features.....	16
Base Illustration	21
Base Features.....	21
Basic Base Station Features.....	21
Additional Base Station Features.....	22
Administrator Features.....	22
Charger Illustration	24
Charger Features.....	24
Getting Started	26
Base Station Installation.....	26

Table of Contents

Handset and Charger Installation.....	29
Basic Operations.....	30
Operation Modes.....	30
Making a Telephone Call(For DuraFon PRO only).....	34
Making a 2-Way/ Intercom Call.....	34
Making a Broadcast.....	35
Redial(For DuraFon PRO only).....	36
Receiving a Telephone Call(For DuraFon PRO only)...	36
Receiving an Intercom Call.....	37
Ending a Call.....	38
Adjusting Receiver (Earpiece) Voice Volume.....	38
Placing a Call On Hold(For DuraFon PRO only).....	38
Mute.....	39
Do Not Disturb (Silent Ring).....	39
Key Guard.....	39
To View Missed Call(s) (For DuraFon PRO only).....	39
To Call back from Call Log (For DuraFon PRO only)....	40
Battery Recharge and Replacement.....	40
Advanced Operations.....	41
Handset Registration.....	41

Table of Contents

Advanced Registration.....	42
Handset Group Subscription.....	43
Call Transfer(For DuraFon PRO only).....	44
3-Way Conferencing(For DuraFon PRO only).....	45
Base Select (For DuraFon PRO only).....	45
Call Waiting(For DuraFon PRO only).....	46
Auto-Attendant(AA).....	47
AA Configuration by Administrator.....	48
Change AA Parameters.....	48
Line Dedication.....	50
Outbound Line Selection (For DuraFon PRO only).....	50
Change System Settings by Administrator.....	51
Phonebook Operations.....	52
Broadcast through PBX.....	55
Menu Operations.....	57
Technical Specifications.....	66

Safety Instructions

Caution: Your wireless telephone gives you freedom and flexibility to stay in touch while you move around. However, the safe and responsible use of the phone depends entirely on you. When using your phone equipment, safety instructions should be followed to avoid the risks of fire, electric shock, injury to person, and damage to property.

General Safety Instructions

1. When using your wireless phone, ensure your safety and the safety of others:
 - a. Always watch where you are walking and standing.
 - b. Don't let a phone call distract you from working safely.
2. In an emergency:
 - a. If an emergency occurs, dial the emergency phone number.
Remember: If you are in an area where your phone does not have a clear signal from the base, it is highly probable that the call may not go through. Locate the nearest landline telephone or other communications device to call for help.
 - b. Emergency calls may not automatically provide emergency personnel with your name, phone number or location. Tell the operator
 - i) Your name and phone number.
 - ii) The nature of the emergency.
 - iii) Whether police, fire, or medical assistance is needed.
 - iv) The exact location of the emergency, including address, cross streets, mileposts or landmarks.
3. Notice to Hearing Aid Users: This phone system is compatible with inductively coupled hearing aids.
4. Notice to Cardiac Pacemaker Users: Preliminary studies done by the US FDA and others have shown that, although interference to the implanted cardiac pacemaker may occur when operating very closely, wireless telephones "do not seem to pose a significant problem for

Safety Instructions

pacemaker wearers".

However, until more is known, FDA suggests that people with pacemakers may want to take precautions when using or carrying a wireless telephone to ensure that there is ample distance between the telephone and the pacemaker. Do not carry the handset in a breast pocket. If you have any reason to suspect that interference is taking place, turn off your handset immediately.

Product Safety Instructions

1. Read and understand all instructions.
2. Follow all warnings and instructions including those marked on the product.
3. Changes or modifications to this product not expressly approved by the manufacturer will void the warranty and the FCC authorization to operate the equipment. Use only manufacturer provided accessories.
4. Do not use the telephone near water. Never spill liquid of any kind on this product.
5. Unplug the product from the wall telephone jack and power outlet before cleaning. Do not use liquid or aerosol cleaners. Use damp cloth for cleaning.
6. Do not place this product on an unstable cart, stand or table. The product may fall and cause personal injury or damage to the product or other property. Place the base station and the charger on hard, flat surfaces.
7. Power Outage:
In the event of a power outage, your handset charger will not recharge the handset battery, and the base station will not allow you to make an outgoing call or take an incoming call. Both the charger and the base station require electricity for operation.
You should have a telephone, that does not require electricity, available for use during power outage, or have a temporary backup.

Safety Instructions

power supply.

8. Slots or openings in the product's housing are provided for ventilation. These openings must not be blocked or covered. Placing the product on a bed, carpeting, or other similar surface may block these openings and should be avoided. This product should never be placed near or over a radiator or heat register, or in a built-in installation unless proper ventilation is provided.
9. Never push objects of any kind into this product through housing slots/ openings as they may damage the product, touch dangerous voltage points or short out parts that could result in fire, electric shock, or injury.
10. This product should be operated only from the type of power source indicated on the marking label. If you are not sure of the type of power supply to your home, consult your dealer or local power company.
11. Do not overload wall power outlets and extension cords as this may result in fire or electric shock.
12. To avoid electric shock or burn, do not disassemble this product. Send this product to an authorized service center when service or repair work is required. Call Customer Service for locations near you. Opening or removing covers may expose you to dangerous voltages, electrical currents or other risks. Incorrect reassembling of the product may cause electric shock when the product is subsequently used.
13. Avoid using the product during a storm. There may be a risk of electric shock from lightning.
14. Do not place the product where persons can step, trip, or fall on the product.
15. Do not place conductive objects over or near the antenna.
16. Do not use the product to report a gas leak while in the vicinity of the leak.

Safety Instructions

17. Do not install the base station or the handset charger near microwave ovens, radios, TV sets, speakers, or other electrical equipment. These appliances may cause interference to the product or experience interference from the product.
18. Unplug the base station or the charger adaptor from the wall power outlet and refer servicing to an authorized service center under the following conditions:
 - a. If liquid had been spilled into the product.
 - b. When the power supply cord or plug is damaged or frayed.
 - c. If the product has been exposed to rain or water.
 - d. If the product does not operate normally by following the operating instructions.
 - e. If the product has been dropped or housing has been damaged.
 - f. If the product shows a distinct change in performance.

Battery Safety Instructions

1. Use only manufacturer approved Lithium-Ion (Li-Ion) rechargeable batteries and charger. Do not use other types of rechargeable batteries or non-rechargeable batteries. The batteries could short-circuit, and the battery enclosure may be damaged causing a hazardous condition.
2. Follow the charging instruction in this manual and instruction labels and markings in the handset and charger compartments.
3. Battery must be recycled or disposed of properly. Do not dispose the battery in a fire. The cells may explode.
4. Do not dispose of the battery in municipal waste. Check with local codes for disposal instructions.
5. Exercise care in handling the batteries in order not to short-circuit the battery with conductive materials such as rings, bracelets, keys, pocketknife, and coins. The battery or conductive material may overheat and cause burn or fire.
6. Do not expose batteries to rain or water.
7. Do not open or mutilate the battery. Released electrolyte is corrosive and may cause injury to eyes or skin. The electrolyte may be toxic if swallowed.
8. During charging, the battery heats up. This is normal and is not dangerous.

Regulatory Information

DuraFon PRO & DuraWalkie
FCC ID: NI3-SP922
IC: 3616A-SP922

This device complies with Part 15 of the FCC Rules. Operation is subject to the following two conditions:

- 1) this device may not cause harmful interference, and**
- 2) this device must accept any interference received, including interference that may cause undesired operation.**

Privacy of communications may not be ensured when using this phone.

1. The term "IC": before the radio certification number only signifies that Industry of Canada technical specifications were met.
2. This telephone system complies with rules of the FCC Part 68 and Canadian IC/DOC CS-03. On the bottom of the base station is a label that contains, among other information, the FCC Registration Number, Ringer Equivalence Number (REN) and the Universal Service Order Code, which is RJ-11C in the U.S. or CA-11A in Canada. Your telephone company may ask you for this information.
3. The REN is useful to determine the quantity of devices you may connect to your telephone line and still have all devices ring when your telephone number is called. In most, but not all, areas the sum of the REN's of all devices connected to one line should not exceed 5.0. To be certain of the number of devices you may connect to your phone line, you should contact your local telephone company for the maximum REN in your area.
4. If your telephone equipment causes problems to the telephone network, the telephone company may ask you to disconnect your phone system from the line until the problem has been corrected. Consult with your local phone company for your rights if this happens.

Regulatory Information

5. Your telephone company may make changes in its facilities, equipment, operations, or procedures that could affect the proper functioning of your telephone system. Consult with your local phone company for your rights if this happens.
6. This telephone system may not be used on coin service provided by the telephone company. Connection to party lines is subject to state tariffs.
7. This telephone system has been tested and found to comply with the limits for Class B digital devices, pursuant to Part 15 of the FCC Rules and RSS210 of the DOC Rules. These limits are designed to provide reasonable protection against harmful interference in a general public installation. Operations of these devices may still encounter interference from/to nearby TV's, VCR's, radios, computers, or other electronic devices. To minimize or prevent such interference, the telephone system should not be placed or operated near other electronic devices. If interference occurs, moving the base station and the handset farther away from them will often reduce or eliminate the interference.
8. However, there is no guarantee that interference will not occur in a particular installation. If this telephone system does cause interference to other electronic devices, which can be determined by turning the system off and on, the user is encouraged to try to correct the interference by one or several of the following measures:
 - a. Increase the space separation between the handset or base station and the device that is experiencing interference. We recommend at least 1 meter (about 3 feet) between the system and other electronic devices.
 - b. Connect the base station to a power outlet on a circuit separate from that used by the device experiencing interference.
 - c. Consult the dealer or an experienced electronic technician for help.

Congratulations

You have purchased an exceptional business communications tool from a leading telephone system manufacturer.

The EnGenius DuraFon PRO 4-port Industrial Cordless Telephone System is ideal for the users in various business settings. The DuraFon PRO is the longest range, multi-base, multi-line telephone and 2-way radio communications system providing users unparalleled mobility and flexibility. The EnGenius DuraWalkie handset provides long range 2-way intercom and broadcast communication, without telephone capability. With sophisticated digital signal processing and high quality hardware designs, the DuraFon PRO provides long-range telephone connections, multi-base installation and 2-way handset-to-handset communications in a wide variety of business settings from multi-level office buildings, factories, hotels/resorts, convention facilities, warehouses, farms, business complexes, construction sites, school, car dealerships, grocery, retail stores and other demanding business environments.

The unique 2-way radio feature allows handsets to communicate with each other as digital, full-duplex 2-way radios. Members of work group(s) can be in contact with their co-workers while leaving phone lines available for incoming and outgoing calls. Handsets that are within range of each other can use the 2-way feature even while out of range of the base station. DuraFon PRO can support up to 90 handsets.

Important Warranty Note:

U.S. customers: This EnGenius product has NO manufacturer's warranty unless purchased from an EnGenius Authorized Reseller. To verify a reseller is authorized, please visit our website at: www.engenlustech.com or contact us at 714-432-8668.

Equipment Checklist

- 1. In a Base + Handset package(DuraFon PRO), please find the following components:**
 - a. Base Station x 1
 - b. Base Antenna x 1
 - c. Base AC/DC Adaptor x 1
 - d. Handset x 1
 - e. Low Profile Handset Antenna x 1
 - f. Optimal Performance Handset Antenna x 1
 - g. 1700mA Li-ion Battery Pack x 1
 - h. Charger x 1
 - i. Charger AC/DC Adaptor x 1
 - j. Telephone Cord x 4
 - k. Audio-in Cable x 1
 - l. Belt Clip x 1
 - m. User's Manual, Quick Guide, and Warranty Card

- 2. In a Handset package(DuraFon PRO HC or DuraWalkie), please find the following components:**
 - a. Handset x 1
 - b. Low Profile Handset Antenna x 1
 - c. Optimal Performance Handset Antenna x 1
 - d. 1700mA Li-ion Battery Pack x 1
 - e. Charger x 1
 - f. Charger AC/DC Adaptor x 1
 - g. Belt Clip x 1
 - h. Quick Guide, and Warranty Card

- 3. In a Base package(DuraFon PRO BU), please find the following components:**
 - a. Base Station x 1
 - b. Base Antenna x 1
 - c. Base AC/DC Adaptor x 1
 - d. Telephone Cord x 4
 - e. Warranty Card
 - f. Audio-in Cable x 1

Equipment Checklist

4. Optional Accessories

- a. Outdoor Antenna Kit (including antenna and cable)
- b. Lightning Protection Kit (including cable)
- c. DuraPouch
- d. Belt Clip
- e. Spare Battery
- f. Low Profile Handset Antenna
- g. Optimal Performance Handset Antenna
- h. Antenna Splitter (including cable)

Handset Illustration

Handset Features

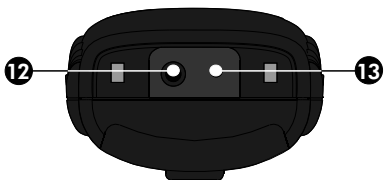
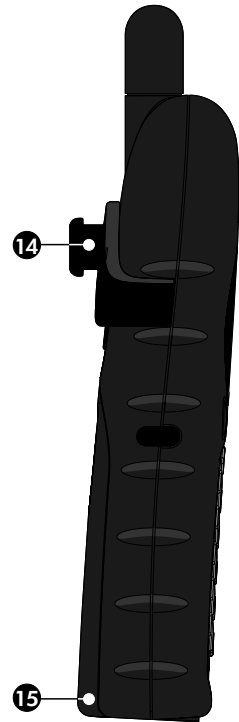
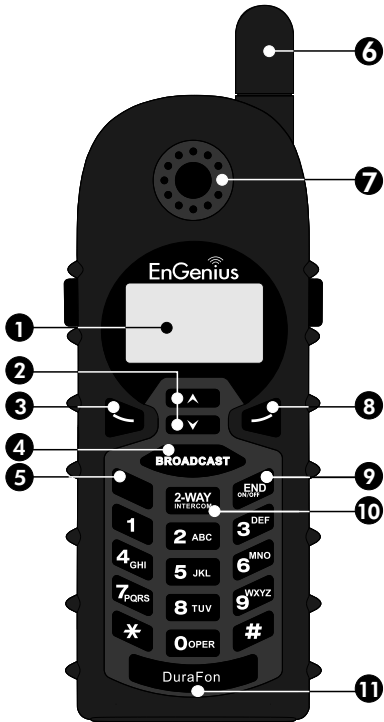

- 1** 4-Line LCD
- 2** Volume control/Scrolling
- 3** Left soft key
- 4** BROADCAST
- 5** TALK/KEY LOCK/KEY LOCK/ (For Walkie)
- 6** Antenna
- 7** Receiver
- 8** Right soft key
- 9** END & Power ON/OFF
- 10** 2-WAY/Intercom
- 11** Microphone
- 12** Travel/charger jack
- 13** Headset jack(2.5mm)
- 14** Belt Clip holder
- 15** Battery pack

Handset Features

Basic Handset Features

1. 4-line LCD (Liquid Crystal Display)

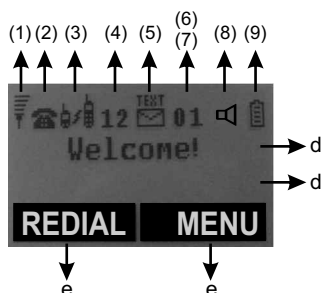

- a. The LCD display has LED (Light Emitting Diode) for backlighting.
- b. The 1st line of LCD consists of icons.
- c. Icons explanation from left to right.
 - (1) **RSSI** (Receive Signal Strength Indicator)
During a call, the number of bars is proportional to the radio signal strength received.
 - ⊙ (2) **Call in-progress** (ON/OFF-Hook)
Indicates if phone line mode is active.
 - (3) **Intercom in-progress**
Indicates if Intercom mode is active.
 - (4) **Handset ID**
Displays a handset icon and a 2-digit Handset ID.
 - (5) **Text Envelope**
Indicates if there is new text message.
 - ⊙ (6) **Two-Digit Address Index**
Shows address index when viewing contents of the call logs, text messages or phonebook.
 - ⊙ (7) **Line Indicator**
Indicates the number of the line being accessed by the handset.
 - (8) **Speaker phone**
Indicates if speaker phone is active.
 - (9) **Battery Strength**
* Number of bars is proportional to the amount of battery time remaining.
* Indicates charging when in charger cradle.

Handset Features

- d. The 2nd and 3rd lines of the LCD, maximum 14 characters each, display status, message, menu selections, or user-editable alphanumeric characters.
- e. The last line displays the left and right soft keys.
Re: There is only right soft key in idle mode of DuraWalkie.
Note: “☉” means only shown on DuraFon PRO handset.

2. Ringer

- a. Rings to an incoming call.
- b. Distinctive alert sounds indicating various events:
 - i. Single Beep: successful key entry.
 - ii. Double beep: failed operation or invalid key entry, also indicates power on/off.
 - iii. Periodic 1-Long-2-Short Beeps (repeat every 10 seconds): low battery warning.
 - iv. Periodic 1-Long-2-Short Beeps (repeat every 30 seconds): indicates a call is on-hold.

3. TALK/ SPEAKERPHONE() (For DuraFon PRO only)

- a. Places or answers a telephone or intercom call.
- b. Sends a Flash signal to phone line to retrieve a dial tone after the call ends, or to perform the call waiting feature provided by local phone companies during a call.
- c. Press and hold the key for one second to enable/disable speakerphone.

4. KEYSLOCK() (For DuraWalkie only)

- a. In Idle mode, press to lock up the keypad
- b. In 2-Way/Intercom mode, press and hold  to enable/disable speakerphone.

5. 2-WAY/INTERCOM()

- a. Places an intercom call to another handset ID or a group ID.
- b. Intercom calls are digital, full duplex, and are conducted without the assistance from the base.
- c. Press and hold  for one second to enable/disable speakerphone.

Handset Features

6. BROADCAST()

- a. Half duplex broadcasting to handsets for immediate announcement.

7. Left/Right (/) Softkeys

- a. Make menu selection.

8. Up()/Down() Scrolling Keys

- a. Scroll through records and menu selections.
- b. Adjust receiver voice volume when in Talk mode.

9. END; On/Off ()Key

- a. Ends a call.
- b. Leaves current menu operation, up one level.
- c. Press for 3 seconds to off the power.

Additional Handset Features

1. Multiple handsets registration

- a. Up to 90 handsets.
- b. ID 10 and 11 are the first two ID's assigned by the base and are designated "administrators" who can change base settings such as greeting message and other base administrative functions.
Note: Unless necessary, it is better not to assign ID 10 and 11 to DuraWakie handsets.
- c. ID 01-07: Group IDs. Handsets can "subscribe" from the handset menu to group(s) and be paged when a landline caller or an intercom caller enters a Group ID.

2. Ringer / Vibrator

- a. Six ringer volume selections
(high/medium/low/vibrate/vibrate-and-ring/off).
- b. Four ringer type selections.

Handset Features

3. Caller ID(For DuraFon PRO only)

- a. Displays incoming call phone number and name on the LCD(needs Caller ID service from local telephone company).

Note: If behind a PBX or Key system, Caller ID information will only be recognized if the PBX or Key system passes that information through the analog ports.

4. Call Waiting with Caller ID(For DuraFon PRO only)

- a. Displays 2nd incoming call information on the same phone line when 1st call is in progress (needs Call Waiting with Caller ID service from local telephone company).

Note: If behind a PBX or Key system, Caller ID information will only be recognized if the PBX or Key system passes that information through the analog ports.

5. Name Tagging with Caller ID(For DuraFon PRO only)

- a. Matches the Caller ID with the phone book entries; once matched, the LCD screen will display the name or nickname instead of pure Caller ID info (needs Call Waiting with Caller ID service from local telephone company).

Note: If behind a PBX or Key system, Caller ID information will only be recognized if the PBX or Key system passes that information through the analog ports.

6. DND (Do Not Disturb, i.e., Silent Ring)

Silences the incoming call ring for current call only.

7. Three Call Logs(For DuraFon PRO only)

- a. Called Log: Stores 10 phone numbers (up to 28 digits each) dialed most recently. Can perform last-number redial on all 10 numbers.
- b. Received Call Log: 10 entries (14-digit phone number, 14-character names, and time stamp), needs Caller ID service from local telephone company.

Note: If behind a PBX or Key system, Caller ID information will only be recognized if the PBX or Key system passes that information through the analog ports.

Handset Features

- c. Missed Call Log: 10 entries (14-digit phone number, 14-character names, and time stamp), needs Caller ID service from local telephone company.

Note: If behind a PBX or Key system, Caller ID information will only be recognized if the PBX or Key system passes that information through the analog ports.

- d. Phone numbers and names can be saved into phonebook while in display.

8. Any Key Answer (except END, Silent Soft Key)

9. Key-guard

10. Dialing Prefix(For DuraFon PRO only)

- a. Up to 14 digits, including pause(s), one access code can be pre-programmed to be added automatically in front of the dialed number when dialing from call logs, phonebook, and dial-and-send dialing.

11. Call Hold(For DuraFon PRO only)

- a. Places call on hold.
- b. Battery Hot Swap: Change battery while call is on hold.

12. Mute

13. Phonebook

- a. 90 entries, each stores a phone number or handset ID (up to 28-digit) and name (up to 14-character).
- b. Alphabetically sorted display and searched by letter.
- c. Dial from display.
- d. During the stand-by mode, you can enter the phonebook by pressing or scrolling key.
- e. Phone book transfer via wireless link.
 - i. Transfer specific phonebook to one handset or all registered handsets.
 - ii. Transfer all phonebooks to one handset or all registered handsets.

Re: For DuraWalkie, it can only store 2-digit handset ID(or Group ID).

Handset Features

14. Key Tone

- a. Three key-tone volume selections (high/low/off).
- b. Four key-tone type selections.

15. Call Timer(For DuraFon PRO only)

- a. Display call time duration for current call during and immediately after the call.

16. Call Transfer

- a. Direct Transfer: transfer a telephone call to another handset without announcement.
- b. Announced Transfer a telephone call to another handset before transferring a telephone call.

17. Call Conferencing(For DuraFon PRO only)

- a. 2-handset and 1-line conferencing.
- b. 1-handset and 2-line conferencing.

18. Line Selection(For DuraFon PRO only)

- a. When enabled from the handset menu, a handset user will be prompted to select from a list of available lines before making an outgoing call.

19. PBX option transfer(For DuraFon PRO only)

- a. PBX options transfer via wireless link.
- b. Transfer specific PBX option to one handset or all registered handsets.
- c. Transfer all PBX options to one handset or all registered handsets.

20. Base Selection(For DuraFon PRO only)

When enable from the handset menu, a handset user can manually select the base which is the nearest one with user before making an outgoing call.

Base Illustration

Base Features

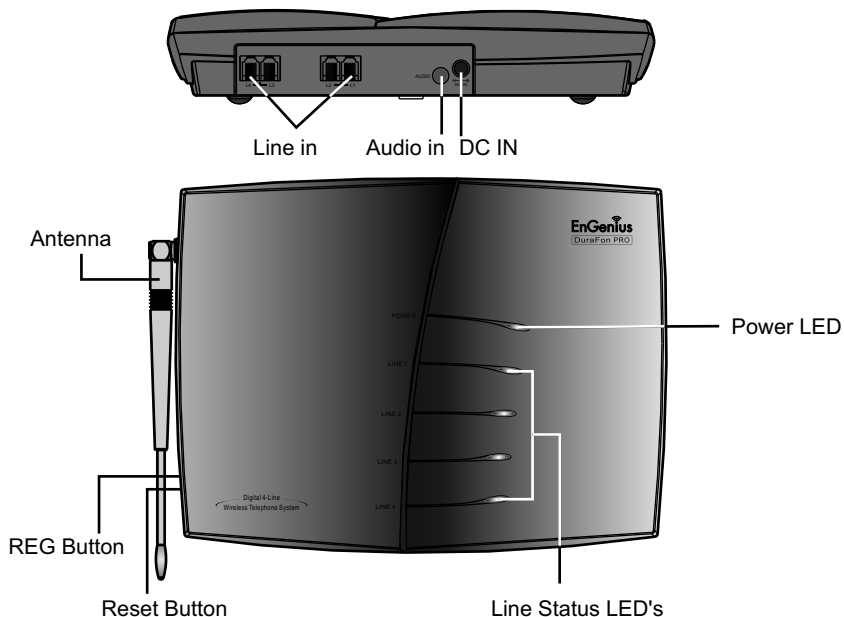

Basic Base Station Features

1. Antenna

- The antenna port has a **reverse thread connector**; to remove antenna or cable, turn clockwise; to install, turn counterclockwise. Improper installation may damage the connector.
- When using an outdoor antenna, locate the antenna (not the base station itself) as high as possible for a clear transmission path.

2. LED

- Power: Indicates base station has power.
- In-Use: Indicates an active telephone line.

Base Illustration

3. Reset Button

- a. Restores base station to factory settings.
- b. Reset button is indented to prevent accidental system reset.
- c. All handsets (including administrator) and additional base(s) need to be re-registered after a base station reset.

4. Registration Key (REG)

Enters registration mode along with handset, assigns handset ID (10-99).

5. L1~L4

Standard RJ-11C/CA-11A connector to plug in the telephone line.

6. Audio-in Jack (3.5mm)

7. DC In: to plug in the power adaptor

Additional Base Station Features

1. 4-channel Auto-Attendant

- a. 4 Auto-Attendant can be active at the same time in case of 4 simultaneous incoming calls.
- b. Allows private paging to a single handset (with individual Handset ID) or group paging to a group of handsets (with Group ID).
- c. Per line AA enable/disable by administrator.
When disabled for a line, the administrator can set all handsets to ring with an incoming call on that line, or a particular Handset/Group ID (either one; not simultaneously) can be assigned to have both incoming and outgoing call privileges on that line. See AA Configuration by Administrator.
- d. Up to 128 seconds customizable main greeting message.
- e. Default of 4 lines AA is OFF.

Base Illustration

2. Optional Outdoor Antenna Kit with cable

Administrator Features

Handsets 10 and 11 are designated administrators. Both have the same authority to perform base station administrative functions from their handset menu selections. No password is required.

1. Supports both DTMF and Pulse dialing (For DuraFon PRO only)

- a. From an administrator handset (Handset 10 or 11), press **MENU** **9** → **1** → enter base ID(00 – 07) → **1** to select Tone or Pulse dialing mode.
- b. Default is Tone dialing.

2. Administrator programmable Flash key timing (For DuraFon PRO only)

- a. From an administrator handset (Handset 10 or 11), press **MENU** **9** → **1** → **2** to select flash key timing.
- b. 9-level (100 ms - 900 ms) timing selections, default= 600 ms.
- c. The default value (600 ms) works in most areas. Changing this setting may result in Flash function not working. Change only when you are certain the new value will work.

3. Call Transfer to PBX Extension(For DuraFon PRO only)

- a. When the DuraFon PRO is installed behind a PBX system, you can pre-program the feature code of call transfer function.
- b. The Flash time is set at 600ms, by default, and may be changed to match PBX settings.

Re:If loosing administrator handsets (handset 10 and 11), all settings must be reset (reset the base and re-register all handsets).

Charger Illustration

Charger Features

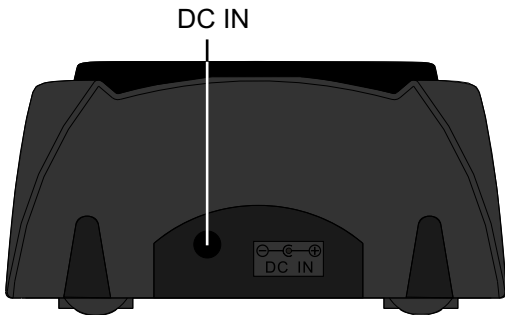
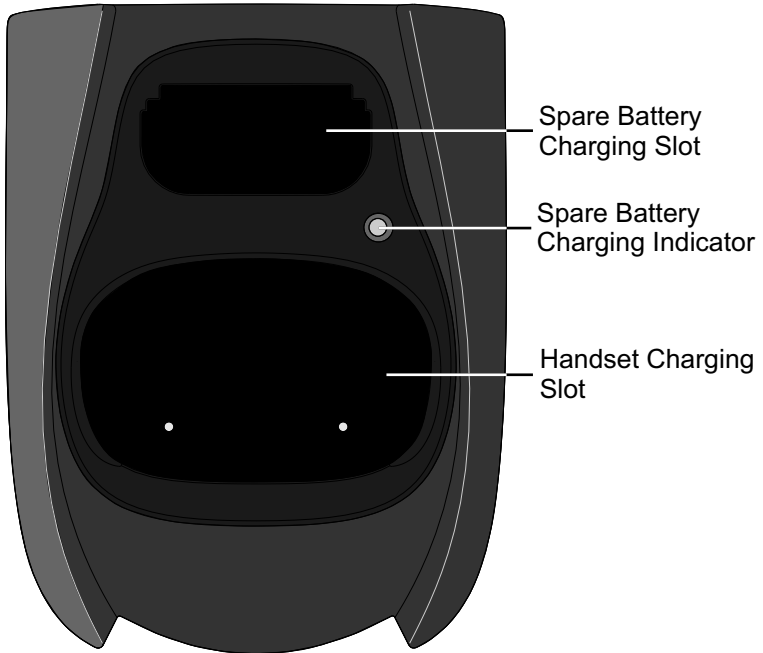

Charger Features

1. DC In

Connects to Charger AC Adaptor.

2. Handset Charging Slot

- a. Charge handset battery when handset is placed in cradle.
- b. Refer to the handset LCD for charging status.
 - i. Charging: LCD screen showed “Charging”.
 - ii. Fully Charged: battery status bar stands still and the LCD screen would display “Fully Charged”.
 - iii. Charge Fail: Should an error occur during charging mode, the LCD screen would display “Charge Fail”.

3. Spare Battery Charging Slot

- a. Charge spare battery when battery is placed in slot.
- B. LED as the spare battery charging indicator.
 - i. Slot is empty and the power is on: LED is Green light.
 - ii. Charging: LED is Orange light.
 - iii. Fully Charged: LED returns to Green light.

4. It is impossible to overcharge the battery using this charger.

5. The AC adapter can be used as a travel charger and plugged directly into the handset’s DC port (located next to the headset port).

However, you can not turn off the power while charging with the travel charger. A Warning message: “Unplug Travel Charger then OFF” will be shown on the LCD display.

Notes:

1. Fully charge battery packs before first use.
2. Both handset and spare batteries can be charged at the same time.
3. Handset will be “power on” automatically when placing on the charging slot.
4. However, if you run down the battery, it will take around one minute for handset to auto power on.
5. Removing a ringing handset from the charging cradle will auto answer the call.

Getting Started

Base Station Installation

For best performance, maintain a distance of at least 1 meter (about 3 feet) between the base station and other electronic devices (e.g., TV, computer, stereo, fax machine, answer machine, cordless phone, etc.).

1. Install base station antenna.

The base station's antenna port has a reverse-thread connector; to install antenna or cable, turn counter-clockwise; to remove, turn clockwise. Improper installation may damage the connector.

2. Plug the transformer end of the base station AC/DC adaptor into a standard AC electrical power outlet, plug the other end into the "DC In" jack on the back of the base station.
 - a. The base adaptor's DC plug is larger in dimension than the charger's DC plug. The charger adaptor's DC plug will not fit into the base's DC In jack.
 - b. The base station's power supply (DC Adaptor) and telephone line should be plugged into a surge protector with phone line protection.
3. Plug one end of the phone cord into one of the 4 phone jacks marked L1 ~ L4 and plug the other end into the telephone outlet. Since DuraFon PRO has the built-in "line detection" feature, it is okay to plug in the phone jacks in random order.
4. Connect an external telephone answering device by following the instructions that come with the answering device. An exemplary configuration: install the external answering device in-between the wall phone jack(s) and the Base Station. Either a multiple of single-line answering devices or a multiple-line answering device can be used.

Getting Started

- To use the Music/Message-On-Hold feature: Connect one end of a standard audio cable into a radio or audio player, and plug the other (3.5 mm) end into the MOH jack on back of the base.

Notes:

Recommended phone line features from the local phone company: Multiple phone lines “hunt group” is a useful feature and works well with this phone system. This feature “ties” multiple phone lines to a single phone number. When an outside caller calls this common phone number, the phone company automatically finds a free line. In a hunt group, the Call Waiting and the Caller ID with Call Waiting (or called Type II Caller ID) features are unnecessary because a 2nd call will come in on a separate line, rather than on the same line. For a 2nd call coming in on a separate line, the phone system's built-in Call Waiting feature will alert the user and allow the user to toggle between 2 lines.

Multi-base setups:

EnGenius DuraFon PRO has the capability to expand the coverage or capacity.

Re: For best performance, maintain a distance of at least 10 meters (about 30 feet) between any two base stations.

* Expanding coverage :

Parallel connects all L1/L2/L3/L4 in each base as below schematic (up to 8 bases), the use coverage will be several times increased.

Note: Telephone calls cannot be handed off between base units.

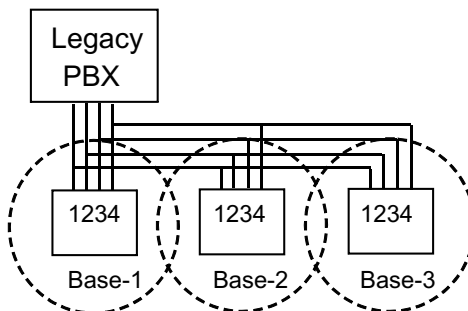

Getting Started

Re : when a call is coming in from L1, any handset can pick up the call, as long as the handset are in the coverage of base1~3.

1. Handset Registration.

- Press **REG** button on Base "00" (default), four LEDs will light up in setting mode.
- Handset operation: Press **MENU** → **6** → **1** (It will complete the registration process).
- Repeat, as needed, to add handsets.

Note: Additional handsets should be added to the system before adding additional base units.

2. Establishing additional Base Units:

- Press **REG** button on new Base.
- Use Handset 10 or 11 to add base :
Press **MENU** → **8** → **1** .
- Enter 01~07 (Base ID).
- Repeat, as needed, to add base units.

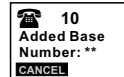
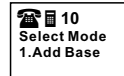

Notes:

- Only Handset 10, 11 can assign Base ID.
- Base "00" is a primary base. All handsets must register only on Base "00".

*Expanding capacity:
User capacity can be increased by adding additional base units.
Up to 8 base units can be supported.

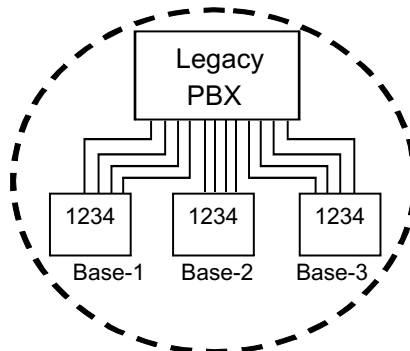

Getting Started

Re : Handsets can answer calls from any port or line, unless port is dedicated to a specific handset or group.

1. Handset Registration.

- Press **REG** button on Base “00” (default), four LEDs will light up in setting mode.
- Handset operation: Press **MENU** → **6** → **1**.
(It will complete the registration process).
- Repeat, as needed, to add handsets.

2. Establishing additional Base Units:

- Press **REG** button on new Base.
- Use Handset 10 or 11 to Add base :
Press **MENU** → **8** → **1**.
- Enter 01~07 (Base ID).
- Repeat, as needed, to add base units.

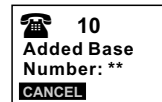
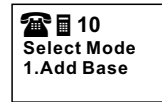

Notes:

- Only Handset 10, 11 can assign Base ID.
- Base “00” is a primary base. All handset must register only on Base “00”.
- To avoid interference, the interval between any two bases should be at least 10 meters (about 30 feet).

Handset and Charger Installation

- Plug the transformer end of the Charger AC/DC adaptor into a standard AC electric power outlet, plug the other end into the “DC In” jack on the back of the Charger.
- Install battery pack onto the handset.
- Install handset antenna.
- Place handset onto the charger front slot.
- The phone system is now ready to perform basic functions such as making and receiving phone calls and intercom calls. No base station handset programming is needed for basic operations.

Basic Operations

Operation Modes

Both the base station and handset have levels of operation at which time only certain procedures of functions can be performed.

Re: The main difference between DuraFon PRO and DuraWalkie is the handset of DuraFon PRO has the capability to make telephone calls, and the handset of DuraWalkie does not.

A. Base Operation Modes

1. IDLE mode- this is the default mode. The “Intercom”, “Broadcast”, and “Volume keys” are active in IDLE mode.
2. TALK mode- the base operates in this mode during a phone call, intercom use, and broadcast operation. The “In Use”, “Intercom”, and “Broadcast” LED will light up respectively.
3. REGISTRATION mode- the base enters this mode by pressing the **REG** button for three seconds. There are no active base unit keys once this mode has been entered. Four LEDs will light up in Registration mode.

B. Handset Operation Modes

1. IDLE mode- this is the default mode.
 - a. If there is no on-going activity, the handset automatically goes into SLEEP/IDLE mode to save battery power.
 - b. The handset can be turned off completely by holding down the **END** key for 3 seconds.
 - c. The idle screen display (custom name) can be edited.
 - d. The 2-digit number represents the handset ID.
2. Menu mode
 - a. Press the (Right softkey) function key to activate MENU mode.
 - b. In MENU mode, the handset settings and information contained in memory can be changed.
 - c. The functions available through the MENU selection are covered in greater detail from page 53.
 - d. The MENU structure display as below:

Basic Operations

6. Charging cradle may be wall mounted, but an “L” bracket should be used for support under the cradle to avoid breaking mounting slots. An “L” bracket is not included, but can be purchased from a local home center.

Note:

1. The handset packaged along with a Base Station is pre-registered at the factory. If you have a new handset, you will need to register the handset with the base station in order to be recognized as a member handset by the base and by other handsets. See Handset Registration.
2. Fully charge battery packs before the first usage.

Basic Operations

DuraFon PRO

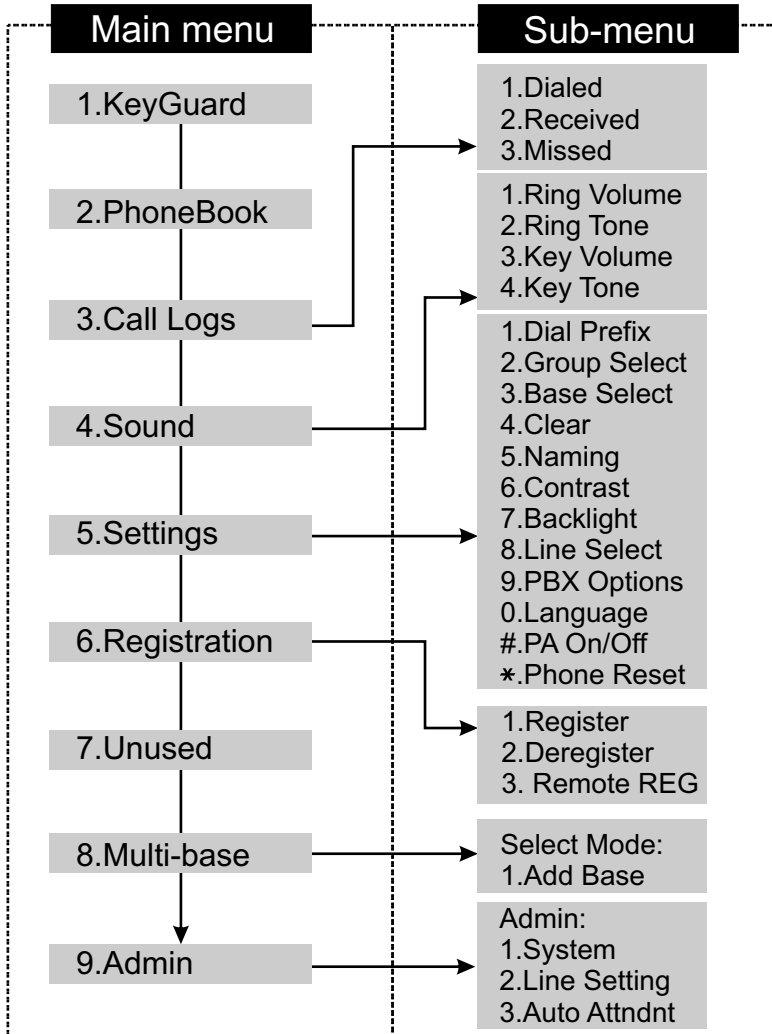

Basic Operations

DuraWalkie

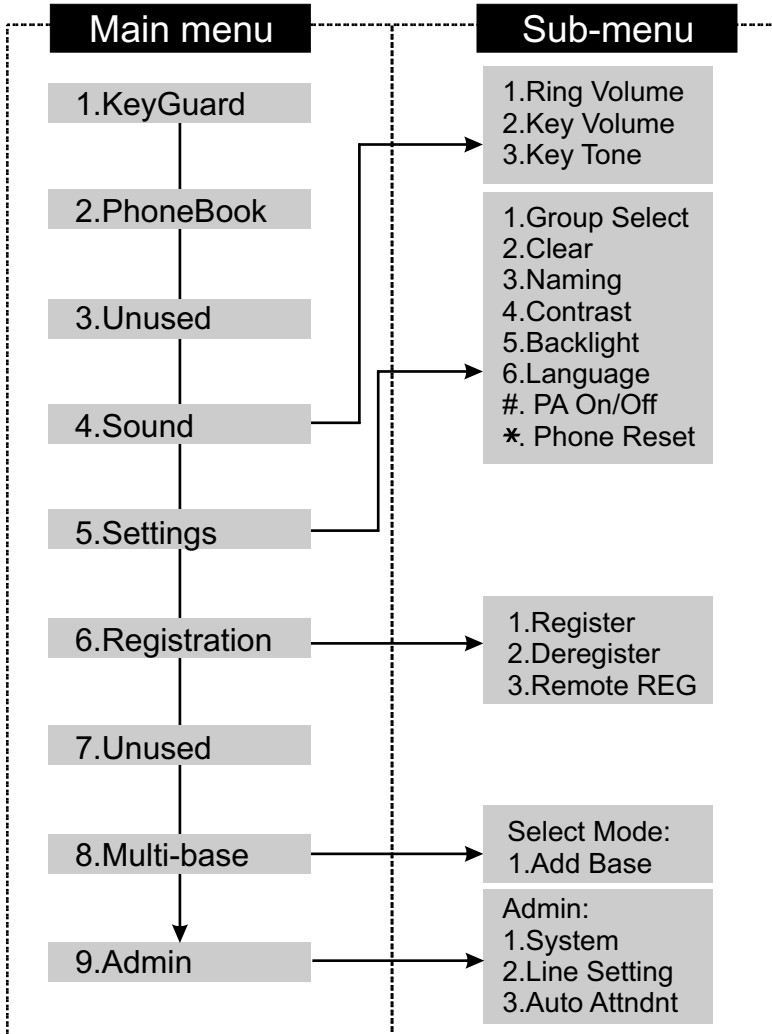

Basic Operations

Making a Telephone Call (For DuraFon PRO only)

1. Press **TALK** , wait for dial tone, and then enter phone number.
2. Alternatively, you can enter phone number first then press **TALK** Key. When using this method, you can use the **CLEAR** (Left) and **DELETE** (Right softkeys) to edit the number entered. “Delete” erases the last digit entered. “Clear” erases the entire line but remains in the dialing mode.
3. Speed dial by access the entries in the phone book.
 - a. Press **▲** or **▼** scrolling key to enter the phone book.
 - b. Press **TALK** to dial the number.
4. To abort dialing, press **END** key.
5. During the call, press and hold the **TALK** Key to activate the speakerphone.

Notes:

1. After a link is established, the Base ID will appear on the upper-right corner.
If no Base ID shows up, it implies that you are approaching the boundary of the coverage.
2. If the line is occupied, the LCD shows “No Line Available” and handset returns to standby mode.
3. If a link cannot be established, the LCD will show “No Connection” after a 12-second time out.
4. A call duration timer will start displaying the length of the call after link is established.

Making a 2-Way/ Intercom Call

The EnGenius Industrial Cordless Phone System offers private, Intercom/2-way radio calls independent of the base station. Intercom/2-way communication can be placed from handset to handset. Handset to Handset Calls.

Basic Operations

1. Press **INTERCOM** key followed by a two-digit handset ID or Group ID.
2. Press **END** key to end the call.
3. During the call, press and hold the **TALK** Key, the speakerphone is active.

Notes:

1. Intercom calls can be made regardless if the Base Station is present.
2. If a Group ID is entered, the first handset (belonging to that group) that answer will establish a link with the caller. See Handset Group Subscription.
3. If a link cannot be established, the LCD shows “No Connection” after a 12-second time out.

Making a Broadcast

1. Broadcasting all handsets.
 - a. Press & hold **BROADCAST** key from one handset.
 - b. A series of beeps will indicate initiation of handset broadcast to all handsets within communication coverage.
 - c. Begin speaking after the series of beeps has ended.
 - d. Release **BROADCAST** key to end the broadcasting.
2. Broadcasting a group of handsets.
 - a. Enter the Group ID and then press & hold **BROADCAST** key.
 - b. A series of beeps will indicate initiation of handset broadcast to all handsets within communication coverage.
 - c. Begin speaking after the series of beeps has ended.
 - d. Release **BROADCAST** key to end the broadcasting.
3. Broadcasting an individual handset.
 - a. Enter the Handset ID and then press & hold **BROADCAST** key.
 - b. A series of beeps will indicate initiation of handset broadcast to all handsets within communication coverage.

Re: When the handset is in use with a call or put a call on hold, it can't be enabled with broadcast.

Basic Operations

Notes:

1. You need to continuously press **BROADCAST** key when doing broadcast. The broadcast will be over once user release the key.
2. You need to notice that there is no bi-bi-beep sound when receiving a broadcast.
3. You can press the **SILENT** (Left softkey) if you choose to ignore the call. The **SILENT** key operation is valid only for the current call. You can silent all broadcast by turning off the ringer to set auto-silence from the handset menu.

Redial (For DuraFon PRO only)

1. Press **REDIAL** (Left softkey).
2. The LCD shows the last phone number dialed. To dial this number, press **DIAL** (Left softkey).
3. Use Up or Down Arrow Key to scroll through the last 10 phone numbers dialed. Select and press **DIAL** key.

Note:

Intercom numbers (Handset ID) are not stored in the last 10 numbers dialed log.

Receiving a Telephone Call (For DuraFon PRO only)

1. When an incoming call arrives, the handset will ring or vibrate unless the ringer has been turned off.
 2. If the handset is on the charger cradle (ringer will be temporarily switched to "Ring" if it has been set to "Vibrate"), lift the handset and start the conversation.
 3. If the handset is not on the cradle, press any key (except **END**, and the **SILENT** softkey) to answer.
 4. During the call, press and hold the **TALK** Key, the speakerphone is active.
- Re:DuraWalkie handset can't receive a telephone call directly, but it can receive a transferred telephone call from PRO handset.

Basic Operations

Also it can transfer the same telephone call to other DuraWalkie or PRO handset. (Details refer to call transfer)

Notes:

1. You can press **SILENT** (Left softkey) if you choose to ignore the call.
Unlike turning off the ringer (from the handset menu), the **SILENT** key operation is valid only for the current call.
2. If Caller ID service is available, the LCD will display the incoming call information. If the LCD shows “Private” or “Unknown”, the caller's information may have been blocked by the caller or the originating phone company.

Receiving an Intercom Call

1. When an intercom call arrives, the handset will ring or vibrate unless the ringer has been turned off. Press **TALK** key to answer the intercom call.
2. If the handset is on the charger cradle (ringer will be temporarily switched to “Ring” if it has been set to “Vibrate”), lift the handset and start the conversation.
3. If the handset is not on the cradle, press any key (except **END** and the **SILENT** softkey) to answer.
4. During the call, press and hold the **TALK** Key, the speakerphone is active.

Notes:



1. The LCD displays the caller's Handset ID.
2. You can press the **SILENT** if you choose to ignore the call. Unlike turning off the ringer the **SILENT** key operation is valid only for the current call.

Basic Operations

Ending a Call

To end a telephone or intercom call, press **END** key or place handset into charging cradle.

Adjusting Receiver (Earpiece) Voice Volume

1. Voice volume can only be adjusted during a call.
2. There are 6 levels of volume selections. Default as volume 4. Use  and  scrolling key to adjust.
3. The new setting remains effective for all future calls until changed or handset is power down.

Placing a Call On Hold (For DuraFon PRO only)

1. For calls held at DuraFon PRO Base only
2. When a call is in progress, it can be put on hold by pressing the **HOLD** (Right softkey).
3. To return to the conversation, press **UNHOLD**.

Notes:

1. The call being placed on hold can only be removed from **HOLD** by the handset that puts it on hold.
2. Handset LCD displays a call is being on hold. An alert tone (double beep) every 30 seconds will remind the handset that a call is being on hold.
3. If the operation (e.g., call transfer) after putting a call on-hold fails, the held call may be dropped.
4. You can power off the handset (e.g., change battery) while call is on hold.
5. After power on again, you can continue the call by pressing **UNHOLD** (Left softkey) or select **3** from the Option menu to terminate the hold state. You can only unhold the call when within

Basic Operations

the coverage area of the base. Once you're out of the base coverage, you can return to stand-by using "Clear hold" function in the "OPTION" list item #3.

Mute

1. After a link is established, you can press **OPTION** (Left softkey) and press **0** to mute the handset microphone.
2. When mute is active, the other party will not hear your voice, but you can still hear the other party.
3. To end the mute, press **OPTION** (Left softkey) and press **0** to unmute the handset microphone.
Re: If established an intercom call, when end the mute, press **UNMUTE** (Left softkey).

Do Not Disturb (Silent Ring)

1. Enter the key sequence **MENU** → **Sounds** → **Ring Volume**, then select "Off". Press **SAVE** to confirm your choice. This will turn off the ringer until it is turned on again from the menu.
2. For temporary silencing the ringer when an incoming call arrives, press **SILENT** (Left softkey).

Key Guard

1. To prevent accidental dialing, you can press **MENU** (Right softkey), then press **1** to select KeyGuard option. The handset keypad is locked. No key entry is accepted except the power on/off key.
2. To unlock the keypad, press **UNLOCK** (Left softkey) then within 2 seconds, press the digit **1** to unlock.
3. Key Guard is in effect until unlocked or powered off.

To View Missed Call(s) (For DuraFon PRO only)

1. Whenever you have missed incoming call(s), you can press **VIEW** softkey to enter the call logs information.

Basic Operations

2. You need to subscribe the caller ID service from local telephone company to retrieve this data.

To Call back from Call Log (For DuraFon PRO only)

1. When you review missed incoming call(s), you can directly call back by pressing **TALK** Key.
2. The displayed CID number in most cases will be a 10-digit number with the 3-digit area code followed by the 7-digit telephone number. If the area code is unnecessary for calling back, you can follow below rule to adjust the calling back number:
 - a. Press **FORMAT** key once, the 3-digit area code will be removed.
 - b. Press **FORMAT** key twice, "1" will be added in front of the displayed number.
 - c. Press **FORMAT** key three times, it will loop back original displayed number.
Re: The CID default is 10 digits, when press **FORMAT** key, it will be 7-digit → 11-digit → 10-digit in circle.
3. After the displayed number chosen, press the **TALK** key to call back.

Battery Recharge and Replacement

1. Charge the battery when one or several of the following happen:
 - a. Phone beeps twice every two seconds.
 - b. Battery icon is empty.
 - c. Phone does not respond when a key is pressed.
 - d. LCD and backlighting become dim.
 - e. A decrease in coverage is experienced.
2. You can replace the handset battery after placing the call-in-progress on hold.
3. Battery talk time and standby time vary depending on the talk/standby pattern and the operating distance. Returning the handset back to the charging cradle as often as possible is recommended for best performance. **Use only manufacturer provided battery and charger!**

Advanced Operations

Handset Registration

1. If your handset is purchased as part of a system, it has been pre-registered with the base station at the factory.
2. If the Handset ID reads "00", that means it is a new handset or the ID has been erased. You need to register the handset with the base station. In certain situations, you may want to change a handset's ID. For example, you want to change a particular handset from a user to an administrator (ID 10 or 11), or vice versa. Or in some rare occasions, you find another handset having the same Handset ID.
3. Registration:
 - a. Press **MENU**-6 to enter the registration mode
 - b. Press and hold the base's Registration **REG** button for 2 seconds until the L1, L2, L3, and L4 LED come on.
 - c. Press handset key **1**, this completes the registration process. The base station will assign a handset ID between 10 and 99. The assigned ID will be displayed on the handset LCD, indicating successful registration.
 - d. Repeat above steps for all additional handsets.
 - e. The first two handsets registered will be given ID 10 and 11, which gives them administrator privileges.
Re : Base "00" is a primary base. All handsets must register to Base "00".
4. De-registration:
 - a. You can de-register a handset from a base. De-registration will reset the Handset ID to 00, erase the system security code, and free up the old ID for future registration.
 - b. After deregistration, the handset will not be able to use the base to make or receive phone calls, nor can it use the intercom to reach other handsets.
 - c. Press handset **MENU** (Right softkey).
 - d. Press the handset number key **6**, this will enter the handset registration menu.
 - e. Press and hold the base's **REG** button for 2 seconds until L1, L2, L3, and L4 LED come on.

Advanced Operations

- f. Press the handset number key **2**, this completes the de-registration process. Upon successful de-registration, the handset will show ID “00”.

Notes:

1. The base has a 30 second registration timeout starting from pressing the **REG** button. The handset has a 12 second registration timeout starting from the time registration or de-registration option has been selected. The base and handset will automatically exit registration mode after timeout.
2. Repeat registration or de-registration process if unsuccessful.

Advanced Registration

1. Advanced registration functions can be performed by administrator handsets (ID 10 and 11) only.
2. Administrator handsets can perform advanced registration function as long as it is within range with the base station. The base station does not need to be in registration mode.
3. De-register a Handset ID by administrator:
 - a. Make sure that the administrator handset is within the coverage range of the base station.
 - b. Press administrator handset **MENU** (Right softkey).
 - c. Press number **9**, this will enter the handset administration menu.
 - d. Press number **1**, handset enters system setting menu.
 - e. Press number **2**, and enter the two-digit Handset ID to be cleared.
 - f. Upon successful operation, the handset LCD will display “Done”, otherwise it will show “Message not received, try again”.
4. Obtain a Specific Handset ID:
 - a. If a particular Handset ID is preferred over sequentially assigned ID, the administrator can “tel” the base in advance what the next ID assignment should be.
 - b. Press administrator handset **MENU** (Right softkey).
 - c. Press the number **9**, this will enter the handset administration menu.
 - d. Press number **1**, handset enters system setting menu.
 - e. Press number **5**, and enter the two-digit Handset ID to be assigned next by the base.
 - f. Upon successful operation, the handset LCD will display “Done”, otherwise it will show “Message not received, try again”.

Advanced Operations

- g. If the handset ID is already in use by another handset, the administrator will be alerted. In that case, the administrator can choose another ID or asks the handset having the desired ID to vacate by de-registering with the base.
 - h. Perform registration immediately afterward for the handset desiring a specific ID to ensure that the ID is not taken by another handset.
5. Remotely register Handset:
- a. If base install in ceil or higher location, administrator handsets can perform remote registration.
 - b. Press administrator handset **MENU** (Right softkey).
 - c. Press the number **6**, this will enter registration mode.
 - d. Press the number **3**, this will replace the procedures to press & hold the base **REG** button until the L1, L2, L3 and L4 LED come on.
 - e. Proceeding the handset registration process for new handsets.

Notes:

1. De-registration by the administrator will disable a handset's ability to use the base station to make or receive phone calls. This also frees up the ID for future registration.
2. Handsets de-registered by the administrator can still perform intercom to other handsets.

Handset Group Subscription

1. Up to seven handset groups (01-07) can be defined and handsets can decide which group(s) they want to be in.
2. For example, Group 1 represents the Customer Service Group, Group 2 represents the Sales Group, and Group 3 is the Marketing Group. Suppose that Handset 11 wants to receive incoming rings for all Sales and Marketing related calls. Then handset 11 will need to "subscribe" to Group 2 and Group 3.

Advanced Operations

3. Group Selections:

- a. Press handset **MENU** → **5** to enter the handset setting menu
- b. Press number **2**, handset enters group select menu.
- c. Press **ADD** softkey and enter two-digit group number (01~07) to add membership in a group.
- d. Repeat for all desired groups.
- e. Delete group selections by pressing **DELETE** (Right softkey) and enter group number.

Notes:

1. The handset can change group affiliations at any time.
2. The base (administrator) is not responsible for group assignments. Consequently, it cannot unsubscribe a handset from a group.

Call Transfer (For DuraFon PRO only)

1. While a telephone call is in progress, you can place it on hold and transfer the call.
2. Press **HOLD** softkey to put call on hold.
3. Press **OPTION** softkey to enter feature list for selection.
4. Press number **2** and enter a two-digit Handset ID to call another handset extension.
 - a. Un-announced Call Transfer:
Press **END** before the destination handset answers, the call is automatically transferred to the destination handset.
 - b. Announced Call Transfer:
 - (1) Speak to the destination handset.
 - (2) Press **XFER** softkey or the **END** to end announcement. The call is transferred to the destination handset.

Notes:

1. If the destination handset does not answer after handset paging timeout, the call is routed back to the originating handset.
2. Above described "Call Transfer" is for DuraFon PRO handset-to-handset call transfers.

Advanced Operations

3-Way Conferencing (For DuraFon PRO)

1. While a telephone call is in progress, you can place call on hold and bring in another phone line or another handset for a 3-way conference.
2. Press **HOLD** (Right softkey) to put the current call on hold.
3. Press **OPTION** (Right softkey) to enter selection menu.
4. 3-Way Conferencing with a Second Handset:
 - a. Press number **2** and enter a two-digit Handset ID to call another handset extension.
 - b. After the second handset answers, press the **CONF** (Left softkey).
 - c. Two handsets and one phone line can now talk simultaneously. Any one party can drop out of the 3-way conferencing, leaving the remaining two parties still connected.
5. 3-Way Conferencing with a Second Phone Line:
 - a. Press number **1** and enter a phone number to call another phone line.
 - b. After the second line answers, press the **CONF** (Left softkey).
 - c. One handset and two phone lines can now talk simultaneously.
 - i. If one phone line hangs up, the handset continues talking to the remaining phone line.
 - ii. If the handset presses **END** key, the 2nd phone line will be dropped.
The handset and the first phone line continue conversation.

Notes:

1. 3-way conferencing between 3 handsets is not supported.
2. Unlike 3-way conferencing provided by the phone company, 3-way conferencing involving 2 phone lines will take up two physical lines, leaving only two lines left available for other handsets.
The handset must have access to a second line.

Base Select (For DuraFon PRO only)

1. A handset can manually select the desired base station before access outbound line.
2. Press handset **MENU** (Right softkey).
3. Press the number **5**, this will enter the handset setting menu.

Advanced Operations

4. Press number **3**, handset enters Base Select setting mode.
5. Use **▲** or **▼** arrow to scroll up and down the selection (On/Off)
6. Make a selection (default =off), and press **SAVE** (Left softkey).
Re: When turns on the Base Select, you must enter 2-digit Base ID after press the **TALK** key.

Notes:

1. Because this setting allows handset manually select the base station, the handset must be in range with the desired base station.

Call Waiting (For DuraFon PRO only)

1. A handset, while talking on one phone line, can be informed of the arrival of a new incoming phone call.
2. For example, suppose that Handset 15 is talking on Line 1. When a new call comes in on Line 4 and the caller enters extension number *15* when prompted by the AA, or if the call is set to be routed to Handset 15 when AA is disabled.
3. The base station recognizes that Handset 15 is busy. Instead of announcing to Line 4 that Handset 15 is busy, the base sends an alert to Handset 15.
4. Upon receiving the alert, the handset sounds an audible double beep alert and LCD displays “New call on Line 4”.
5. Handset 15 can:
 - a. Ignore the new call; continue talking to Line 1.
 - b. Press **Switch** key to switch to Line 4.
 - c. Subsequent pressing of **FLASH** key will toggle between Line 1 and Line 4.
 - d. Press **END** key while talking to a line will terminate that particular call and automatically switch back to talking to the remaining line.

Notes:

1. This built-in call waiting is separate from the Call Waiting feature available from the local phone company. The phone company provided Call Waiting functions on the same phone line, while the DuraFon Call Waiting functions on two separate phone lines.
2. This feature only works for 2 lines, if a 3rd phone call comes for the same handset, the call will not be routed to the handset.

Advanced Operations

3. It is recommended to order from the local phone company Hunt Group feature for all your lines and not subscribe to the Call Waiting feature.

Auto-Attendant (AA)

1. When enabled by the administrator, an automated attendant would greet a telephone line incoming call.
2. The caller will be prompted by the greeting message to enter a two-digit extension number (Handset ID) or press **0** for operator.
3. The greeting message is user programmable. The Handset ID that is designated as the operator is also user programmable.
 - i. Default greeting message (Main OGM): "Please enter the extension number or press **0** for the operator".
 - ii. Default operator: Handset 10.
4. AA will ask for another handset ID if the first entry is invalid (no registered handset with that ID) with the announcement (OGM2): "The extension you entered is invalid, please try another extension or press **0** for the operator".
5. If there is no entry time out, AA will announce (OGM3): "Please hold, your call is being transferred to the operator". And automatically ring the operator handset.
6. If the destination handset does not answer (busy, power off, or out of range) after handset paging time out, the AA prompts the caller for another extension number by announcing (OGM5): "The extension you've entered is busy or not available. Please enter another extension number or press **0** for the operator".
7. If the 2nd try is still not successful, AA will announce (OGM4): "Sorry, nobody can answer your call right now. Please try again later, goodbye". Then drops the call.
8. When the DURAFON PRO base station is connected to wired PBX extension lines, calls addressed/routed to the AA operator can be sent back to the operator of the wired PBX system. From an administrator handset, up to 10 keys/digits are allowed to program a specific code in order to transfer the calls back to the wired PBX. This feature can only be enabled and pre-programmed by an administrator handset (Handset ID 10 or 11). Consult with the wired PBX manual for operation instructions and correct key sequence for transfer calls to the operator from an extension.

Advanced Operations

Notes:

1. Intercom calls are not routed by Auto-Attendant.
2. Routing messages OGM2,3,4 and 5 are not user programmable.
3. The timeout is 5 seconds for entering extension number.
4. The calls can be routed to either a Handset ID or an extension number of the wired PBX system, There can be only one operator for the AA, which is either an DURAFON PRO handset or the wired PBX operator.
5. Call routing is at most 2 hops. That is, if both the 1st and th 2nd handsets do not answer, the call will be terminated if the operator does not answer.

AA Configuration by Administrator

1. Administrator can change the following AA settings:
 - a. Record/playback new main greeting message.
 - b. Set number of rings before AA picks up a call.
 - c. Turn on/off the AA line-by-line.
 - d. Set Designated Handset ID for AA disabled line(s). Either the Designated Handset ID or the Group ID can use that particular line for incoming and outgoing calls. Which means this specific line(s) will be dedicated to a particular handset (Handset ID 10-99) or a calling group (Group ID 01-07).
 - e. Designate an operator, the handset which would answer un-routable calls or when the caller chooses “Operator” when prompted.

Change AA Parameters:

- a. From an administrator handset (Handset 10 or 11), press **Menu** (Right softkey).
- b. Press number **9**, this will enter administration menu.
- c. Press **3**, handset enters AA setting menu.
 - i. Press **1** and follow instruction to record new greeting message.
 - ii. Press **2** to playback the current greeting message.
 - iii. Press **3** to set number of rings before the AA picks up a call. Use Up/Down arrow to choose between 2 and 9 rings.

Advanced Operations

- iv. Press **4** to turn AA On/Off. This can be done separately for each phone line by using Up/Down arrows to scroll through Line 1 to Line 4, and press **On** or **Off** softkey to turn AA On/Off. If turning off the AA may be useful when:
- The line is not used by a group of people.
 - External answering machine is to be attached to the line.
- v. Press **5** and select from the following two options to set Operator for AA:
- “Handset” : assign a specific handset as operator by entering a two-digit handset ID (default=Handset 10) as operator for all calls addressed to the operator when AA is on, or
 - “PBX” : transfer calls to be answered by the operator back to the designated wired PBX operator. System administrators must know the proper programming and “call transfer” feature code (available from the user manual of the wired PBX system) in order to perform this function correctly.

The following example is the instruction to route a call back to the brand N’s PBX system by pressing “Flash-7-0-1-8-3-0”, where a Flash key is pressed followed by the call transfer code “70”, then enter the extension number “1830” immediately. Confirm the set up by press **SAVE** using the (Left softkey).

Notes:

1. Only administrator can change AA settings.
2. Because AA setting is stored on the base station, the handset must be in range with the base to make changes.
3. The maximum recording time for the greeting message is 128 seconds.
4. Allowing each line’s AA to be turned on or off separately is useful if different lines are used for different purposes.
5. When AA is disabled, the line can be dedicated to either an individual Handset ID or a Group ID.
6. The operator can be any individual handset or a group; it doesn’t need to be an administrator handset (Handsets 10 and 11).
7. The minimum number of rings before the AA picks up cannot be lower than two for the purpose of receiving the Caller ID message.

Advanced Operations

Line Dedication

1. Line dedication function can be performed by administrator handsets (ID 10 and 11) only.
2. By default all incoming calls will ring all handsets .
3. With the administrative handset, press **MENU** → **9** → **2** → **2** for Line Dedication setting.
4. It will first show Line 1 and status. If you wish to dedicate line 1 to a specific handset or group, you need to press **OK**. To dedicate lines 2-4 use **▲** or **▼** scrolling key on the keypad.
5. After choosing a line, it will show **YES** and **NO** , when choosing **YES** , you need to enter the handset ID or group ID for extension number. If you choose **NO** , it will go back to Line setting menu.

Notes:

1. When entering Line Dedication setting, it will show line and status. If line is already dedicated to a specific handset or group, it will show the handset or group ID behind the line. If line isn't dedicated to a specific handset yet, it will show "ALL HS" behind the line.
2. When setting Line Dedication, make sure the handset or group ID is correct to avoid losing calls sent to an DuraWakie handset or invalid ID.
3. Handsets dedicated to a port will also receive calls from non-dedicated line as well as the handset's dedicated line. Use Line Dedication for a group on other lines to further manage calls.

Outbound Line Selection (For DuraFon PRO only)

1. Press **MENU** → **5** → **8** while the phone is in standby to enter Line Select menu.
2. Use **▲** or **▼** to switch between On and Off, default = Off.
3. If set to On, when pressing **TALK** or entering a phone number followed by pressing **TALK** Key, the handset LCD display will show "Select Line" followed by available lines (1~4). Select from one of the available lines i.e. press **1** to select line 1 and press **2** to select line 2.
4. This feature is also supported when selecting a second line during call conferencing.

Advanced Operations

Change System and Line Settings by Administrator

1. There are two system parameters that can be changed by the administrator: clear (de-register) handset ID and set the next handset ID to be assigned by the base.
2. From an administrator handset (Handset 10 or 11), press **MENU** (Right softkey).
3. Press number **9** , this will enter the administration menu.
4. Press number **1** , handset enters System setting menu.
 - a. Dial tone:
Press **1** to set up the dial tone to be either “Tone” or “Pulse” . Press **1** to choose “Tone” or press **2** to choose “Pulse”.
 - b. Flash time:
Press **2** to set up the flash time from 100ms, 200ms, to 900ms (9 levels to choose from.) For example, press **2** if the desired flash time is 200ms. Default flash is 600ms.
 - c. Line Detect:
Press **3** to set up the line detect to be either “On” or “Off” Press **1** to choose “On” or press **2** to choose “OFF”. Default is ON .
 - d. Clear Handset ID:
Press **4** and enter a two-digit Handset ID when prompted to clear this ID for later assignment.
 - e. Set next Handset ID to be assigned:
Press **5** and enter a two-digit Handset ID when prompted. This is the ID that will be given out by the base to the next handset registering with the base.
5. Press number **2** , handset enters Line Setting menu.
 - a. Enter Base ID(00~07) to access base.
 - b. Press **1** to enter Broadcast setting .
 - i. Press **▲** or **▼** to select L3 or L4 (the status of setting will be displayed on LCD)
 - ii. Press **CHANGE** to enter the setting mode, and the base ID will be displayed on LCD.
 - iii. Press **ON** (Left softkey) to enable the broadcast function. Press **OFF** (Right softkey) to disable the broadcast function.

Advanced Operations

- iv. After setting broadcast, press **ON** (Left softkey) to enable the AA. Press **OFF** (Right softkey) to disable the AA.

Re: L3 and L4 can be setting as two broadcast lines, repeated above items for setting 2nd broadcast line.



- c. Press **2** to enter Line dedication setting.
 - i. Select base's line and press handset **OK** (Right softkey).
 - ii. Line Dedicate confirm:
 - Press **NO** (Right softkey) to go back Line Setting Menu.
 - Press **YES** (Left softkey) then enter extension number.

Notes:

1. De-registration by the administrator will disable a handset's ability to use the base station to make or receive phone calls. This also frees up the ID for future registration.













Phonebook Operations

1. You can store up to 90 entries in the phonebook. Each entry can contain a phone number or handset ID (up to 28 digits) and a name (up to 14 characters).

Re: For DuraWalkie, each entry can store 2 digits handset ID or Group ID.
2. To access phonebook, press **MENU** followed by **2** or  or  scrolling key when handset in standby mode.
3. To add a new entry:
 - a. Press **ADD** softkey.
 - b. Enter a phone number when LCD prompts "Number?" Use **DELETE** softkey to delete the last digit entered. Press **SAVE** when completed.
 - c. You will then be prompted to enter a name for the phone number just entered.
 - (1) Press **SAVE** softkey to enter a phone number without a name. All records without a name will be placed on top of the list, in the order they are entered.
 - (2) To enter the name, press the corresponding keypad number one or more times according to the order of the character on the key.
 - (3) Use **DELETE** softkey to delete the last character entered. When completed, press **SAVE** softkey to confirm your selection.

Advanced Operations

Notes:

1. When entering a phone number, the cursor automatically advances to the next digit field. Use  or  scrolling key to move the cursor backward or forward to insert or delete.
 2. When entering a name, the cursor automatically advances to the next character field if you press a different key for the next character. If you need to enter consecutive characters from the same key, you can wait for the cursor to advance or use  or  scrolling key to move the cursor backward or forward manually. Also use  or  to move the cursor to insert or delete.
 3. By default, all letters are entered in the upper case. Use the  key to toggle between upper and lower cases.
 4. A “Pause” entry represents a 2.8 second delay in dialing the following digits, which is useful when calling a sequence of segmented numbers (e.g., access code, credit card number, auto-attendant entries, etc.) Pause is entered by pressing the  key twice (LCD displays P).
Entering pause twice (PP) will result in 5.6 seconds pause in the dialing.
4. The entries are alphabetically sorted and stored as a list in an ascending order (A to Z) from the top of the list.
 - a. If the phonebook is entered from the menu, the first entry displayed is from the top of the list.
 - b. If the phonebook is entered using the  arrow, the first entry displayed is from the top of the list.
 - c. If the phonebook is entered using the  arrow, the first entry displayed is from the bottom of the list.
 5. The first line of LCD display shows name and the 2nd line shows the phone number. If the phone number is longer than 14 digits, press **OPTION** softkey and select Option 3 to view the complete number.
 6. To search for a record:
 - a. Use  or  scrolling key to enter the Phone Book mode.
 - b. Press a key that corresponds to the first character of the name you are looking for.

Advanced Operations

- c. For example, you are looking for “EnGenius”, and then press the number **3** once.
 - d. Use **▲** or **▼** scrolling key to locate the exact record you are looking for .
7. To erase phonebook entry:
- a. Use **▲** or **▼** scrolling key or the alphabetical search method to located the record to be erased.
 - b. Press **OPTION** softkey to enter editing menu.
 - c. Press **1** to erase the designated phone entry.
 - d. LCD shown “Are you sure?” Press Yes to double confirm your change.
8. To edit phonebook entry:
- a. Use **▲** or **▼** scrolling key or the alphabetical search method to locate the record to be edited.
 - b. Press **OPTION** softkey to enter editing menu.
 - c. Press **2** to edit the designated phone entry.
9. Dial from display:
- a. Press **TALK** or Intercom to dial the phone number or Handset ID displayed.
10. To transfer (cloning) phonebook:
- To transfer phonebook, both parties have to enter the phonebook transfer mode firstly by following below:
- a. Press **OPTION** follow by **4** or **▲** or **▼** scrolling key when handset in phonebook mode.
 - b. For phone sending party, press **1** to enter sending mode.
 - i. Either press **TX ALL** (Left softkey) to transfer all phonebook entries to another handset(s).
 - ii. Or press **TX ONE** (Right softkey) to transfer one entry to another handset(s).
 - iii. Press 2-digit handset ID or group ID, then select all phonebook entries or one entry to be transferred.
Re : “00” means all handsets
 - iv. During phonebook transferring, LCD shows “Sending” and 2-digit countdown on the LCD to indicate the phonebook numbers which are waiting for sending.

Advanced Operations

- c. For phonebook receiving party, press **2** to enter receiving mode.
 - i. When entering the receiving mode, LCD shows “Ready”.
 - ii. Start to receive phonebook, LCD shows “Get phonebook from Ext. # : xx” .
 - iii. A beep emitted when receiving each phonebook.
 - iv. When the phonebook receiving, 2-digit countdown on the LCD to indicate the phonebook numbers which are waiting for receiving.
- Re: The phonebook transfer through the wireless interface, it may partially miss transmission by interference.

Notes:

Character Table:

Key	Characters and Orders	Key	Characters and Orders
1	' + , . * () & 1	2	A B C 2
3	DEF3	4	GHI4
5	JKL5	7	PQRS7
8	TUV8	9	WXYZ9
0	0	*	Space when in character editing # when in number editing
#	Toggle case when in character editing * P (Pause) when in number editing		

Broadcast through PBX

1. DuraFon PRO and DuraWalkie both have the broadcast function, each can broadcast another handset without going through the base station, as long as the handsets are connecting. However, when setting up the multi-base, the broadcast feature may not be available due to the coverage range. In that case, you can use the function of “Broadcast through PBX” to broadcast.
2. From an administrator handset (Handset 10 or 11), press **MENU** (Right softkey).
3. Press number **9** , this will enter administration menu.

Advanced Operations

4. Press number **2** , handset enters Line setting menu.
 - a. Enter Base ID (00~07) to access base.
 - b. Press **1** to enter Broadcast setting.
 - i. Press **▲** or **▼** to select L3 or L4 (the status of setting will be displayed on LCD)
 - ii. Press **CHANGE** to enter the setting mode, and the base ID will be displayed on LCD.
 - iii. Press **ON** (Left softkey) to enable the broadcast function. Press **OFF** (Right softkey) to disable the broadcast function.
 - iv. After setting broadcast, press **ON** (Left softkey) to enable the AA. Press **OFF** (Right softkey) to disable the AA.
Re: L3 and L4 can be setting as two broadcast lines, repeated above items for setting 2nd broadcast line.
5. When calling through the line 3 or 4, the caller will be prompted by the greeting message to enter a two-digit extension number ("01" ~ "07" for Group ID: "10" ~ "99" for Handset ID: "00" for all).
 - a. The greeting message: "Please enter the extension number" .
 - b. If there is no entry after 5 seconds, the broadcast will be enabled to all handsets.

Note:

1. Line 3 and or 4 can be reserved for broadcast function.
2. For a single broadcast port; reserve Line 3 for broadcast and line dedicate (see pg. 46) Line 4 to a non-existent handset (ie: 99).
3. A base unit configured with a single broadcast port Lines 1 and 2 may be used as standard telephone ports or lines.
4. For dual broadcast ports; reserve Line 3 and 4 for broadcast and line dedicate Lines 1 and 2 to a non-existent handset (ie: 99)
5. Broadcast is limited to 30 seconds.

Advanced Operations

Menu Operations

DuraFon PRO

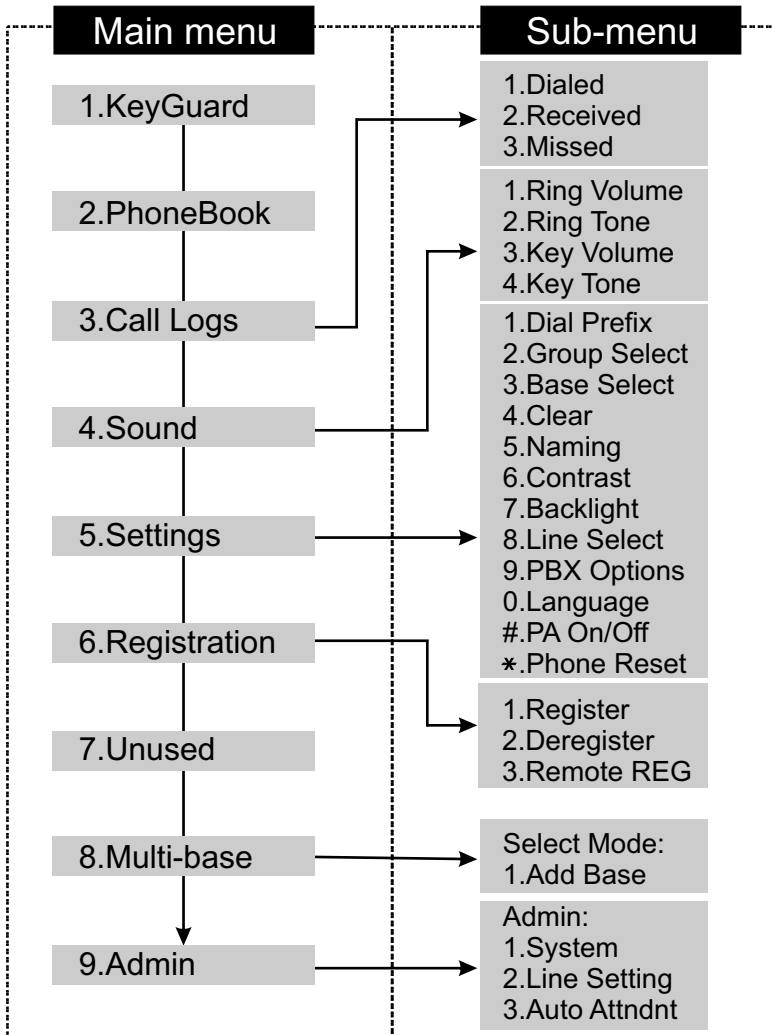

Advanced Operations

1. Press **MENU** (Right softkey) while the phone is in standby.
2. Press **1** to lock keypad (see Key Guard).
3. Press **2** to view, search, erase, edit and transfer the phonebook (see Phonebook).
4. Press **3** to view the last 10 numbers called, received, or missed. Records can be erased or edit/save into the phonebook.
 - a. Press **1** to view the last 10 phone numbers dialed, starting from the most recent one. Use **▲** or **▼** to scroll through the list.
 - i. Press **OPTION** (Right softkey) for options.
 - * Press **1** and confirm to erase the current record.
 - * Press **2** to edit and save or save without editing into the phonebook.
 - * Press **3** to view the complete number if the phone number is longer than 14 digits.
 - b. Press **2** to view the last 10 phone numbers received, starting from the most recent one. Use **▲** or **▼** to scroll through the list.
 - i. Press **OPTION** (Right softkey) for options.
 - * Press **1** and confirm to erase current record.
 - * Press **2** to view the arrival date and time of the call.
 - * Press **3** to edit and save or save without editing into the phonebook.
 - c. Press **3** to view the last 10 phone numbers received but not answered, starting from the most recent one. Use **▲** or **▼** to scroll through the list.
 - i. Press **OPTION** (Right softkey) for options.
 - * Press **1** and confirm to erase current record.
 - * Press **2** to view the arrival date and time of the call.
 - * Press **3** to edit and save or save without editing into the phonebook.
 - d. The two-digit index on the upper right corner of the LCD display shows the location in ascending order, with 01 being the most recent call.
 - e. While viewing any of the three call logs, press **DIAL** (Left softkey) to dial the phone number.

Notes:

1. Only phone numbers are stored in the three call logs. Intercom calls are not recorded.

Advanced Operations

2. Caller ID service is required from your local phone company in order to receive phone numbers, names and time stamps on incoming calls. The Received and Missed Call Logs will register no incoming calls if Caller ID service is not available.
3. The Caller ID feature may not be supported by all PBX or Key systems' analog ports, check with your equipment provider.

5. Press **4** to set sound-related settings:
 - a. Press **1** to select ringer volume: Use **▲** or **▼** to scroll through 6 options: Low, Medium, High, Vibrate, Vib and Ring, Off. Press **SAVE** (Left softkey) to save selection. Default = High.
 - b. Press **2** to select ringer tone: Use **▲** or **▼** to scroll through 4 options: 0, 1, 2, and 3. Press **SAVE** (Left softkey) to save selection. Default = 0.
 - c. Press **3** to select key volume when a key is pressed: Use **▲** or **▼** to scroll through 3 options: High, Low, and Off. Press **SAVE** (Left softkey) to save selection. Default = Low.
 - d. Press **4** to select key tone: Use **▲** or **▼** to scroll through 4 options: 0, 1, 2, and 3. Press **SAVE** (Left softkey) to save selection. Default = 0.
6. Press **5** to change handset settings:
 - a. Press **1** to set dialing prefix:
 - i. Use **▲** or **▼** to scroll and select to turn on or off the dialing prefix feature. Default = Off.
 - ii. If "On" is selected, the handset is prompted to enter a prefix, up to 14 digits.
 - iii. Use **DELETE** (Right softkey) and **▲** or **▼** to edit prefix.
 - iv. When this feature is turned on, the LCD will prompt the user on each outgoing phone call except during redial or dialing by pressing the **TALK** key first whether to use the dialing prefix. The current prefix is also displayed. Press **YES** (Left softkey) or **NO** (Right softkey) to add the prefix to the beginning of the number.
 - v. This feature is useful for access code, calling card, and credit card calls, etc.
 - b. Press **2** to Group Select: see Handset Group Subscription.
 - c. Press **3** to set or turn Base Select on or off. Default = Off. See Base Select.

Advanced Operations

- d. Press **4** to clear call logs and phonebook:
 - i. Press **1** and confirm to delete the entire phonebook.
 - ii. Press **2** and confirm to clear the three call logs (Called, Received, and Missed).
- e. Press **5** to edit the name of Custom or Line:
 - e-1. Press **1** to change the power-up LCD display to show, e.g., customer name or other greeting message:
 - e-2 Press **2** to change the name of line, when calls coming, it will indicate the calls came from which line.
 - i. Use **▲** or **▼** to move the cursor backward or forward to insert (to the left of the cursor) or delete (the character above the cursor, or left of the cursor if cursor is on the right of the last character).
 - ii. Enter characters using the Character Table and method discussed in the Phonebook section.
 - iii. When finished, press **SAVE** (Left softkey) to save change.
- f. Press **6** to change LCD display contrast:
 - i. Use **▲** or **▼** to scroll through values 1 to 12. Pick one that is most suitable to you. Default = 10.
 - ii. Press **SAVE** (Left softkey) to save setting.
- g. Press **7** to change the LCD backlight:
 - i. Use **▲** or **▼** to scroll through options: On, Off, and 8 Seconds. Default = 8 seconds, meaning that the backlight is always on. The 8-second option will turn off the backlight after 8 seconds of inactivity.
 - ii. Press **SAVE** (Left softkey) to save setting.
- h. Press **8** to change the Line selection:
 - i. Use **▲** or **▼** to scroll through options: On or Off. Default = Off, meaning that you can not select the other available lines to dial.
 - ii. Press **SAVE** (Left softkey) to save setting.
- i. Press "9" to change the PBX options:
 - i. Press **ADD** soft key to edit a PBX feature to be memorized and key in the name of the PBX features just like editing a phonebook entry.
 - ii. Press **SAVE** (Left softkey) to save setting.
 - iii. Press **OPTION** and **1** following by entering PBX options mode, you can erase the PBX option.
 - iv. Press **OPTION** and **2** following by entering PBX options mode, you can edit the PBX option.
 - v. Press **OPTION** and **3** following by entering PBX options mode,

Advanced Operations

you can transfer the PBX options to other handset(s).

Re: To transfer PBX options, both parties have to enter the PBX option mode firstly by following bellow:

For sending party, press **1** to enter sending mode.

- * Either press **TX ALL** (Left softkey) to transfer all PBX options to another handset(s).
- * Or press **TX ONE** (Right softkey) to transfer a specific entry to another handset(s).
- * Press 2-digit handset ID or group ID, then select all PBX options or a specific entry to be transferred ("00" means all handsets)
- * During PBX options transferring, LCD shows "Sending" , and 2-digit countdown on the LCD to indicate the numbers of PBX options which are waiting for sending.

For receiving party, press **2** to enter receiving mode.

- * When entering the receiving mode, LCD shows "Ready" .
- * Start to receive PBX options, LCD shows "Get PBX options from Exit. #: x mm x" .
- * When the PBX options is receiving, 2-digit countdown on the LCD indicates the number of PBX options which are waiting to be received.

Note:

1. Different PBX makers use different analog codes to control PBX function, like call transfer, call park, etc.; Please refer to your PBX maker's manual for this information.
2. Errors may occur in PBX options and phonebook entries transferred wirelessly due to interference. Please re-enter entry manually if problems occur with a entry.

J. Press **0** to change Language:

- i. Use **▲** or **▼** to scroll through options: English, Spanish, and French. Default = English, meaning the LCD display shows in English.
- ii. Press **SAVE** (Left softkey) to save setting.

Advanced Operations

K. Press **#** to turn Broadcast On/Off.

- i. Press **ON** (Left softkey) to turn on the broadcast function (including the broadcast of handset to handset and base to handset).
- ii. Press **OFF** (Left softkey) to turn off the broadcast function
Re: When broadcast setting "Off", there is an icon indicated in the display, side of the battery icon.

I. Press ***** to make phone Reset.

- i. Press **1** to clear all setting and return to default (all phonebooks, CID logs, handset registration will be cleared).
- ii. Press **2** to clear all setting but keep handset registration as will.

7. Press **6** to register or de-register handset: See Handset Registration.

8. Press **8** to add new bases:

From an administration handset (Handset 10 or 11) to set new Base 01~07.

Maximum bases is up to 8. Before adding a new base, the Handset must be registered in master base (Base ID=00).

A. Press **REG** button on new Base.

B. Use Handset 10 or 11 to Add base: Press **MENU** → **8** → **1**

c. Enter 01~07 (Base ID).

9. Press **9** to change system and Line setting: See System setting and Line Setting.

Advanced Operations

DuraWalkie

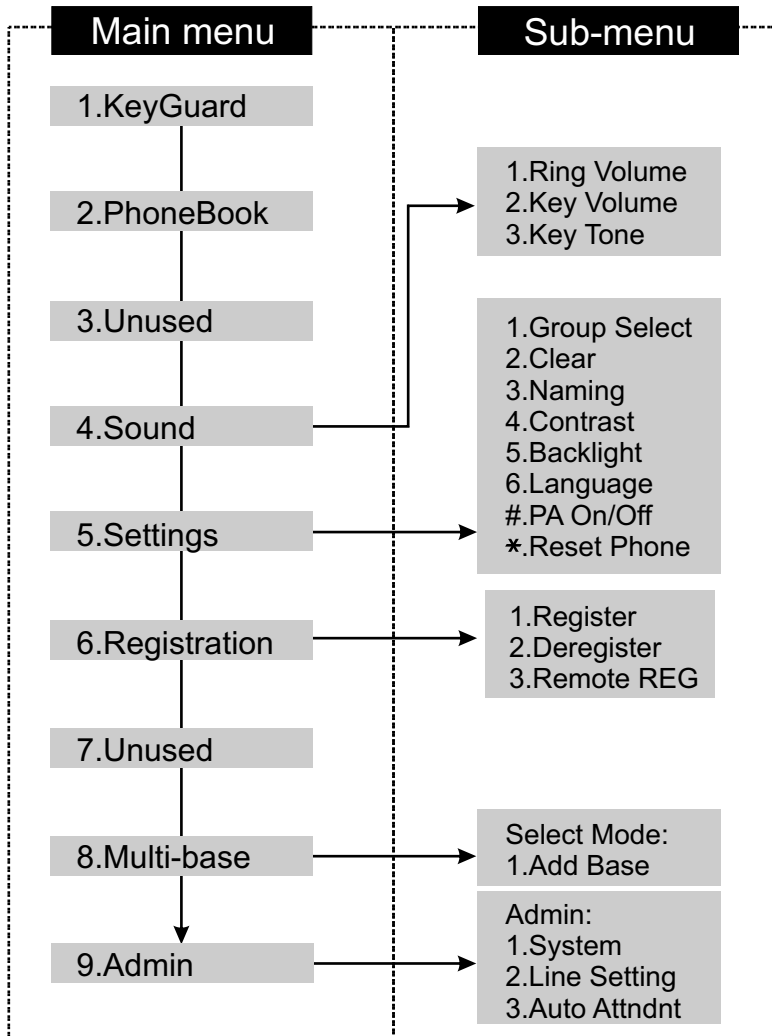

Advanced Operations

1. Press **MENU** (Right softkey) while the phone is in standby.
2. Press **1** to lock keypad (see Key Guard).
3. Press **2** to view, search, erase, edit and transfer and edit the phonebook (see Phonebook).
4. Press **4** to set sound-related settings:
 - a. Press **1** to select ringer volume: Use **▲** or **▼** to scroll through 6 options: Low, Medium, High, Vibrate, Vib and Ring, Off. Press **SAVE** (Left soft key) to save selection. Default = High.
 - b. Press **2** to select ringer tone: Use **▲** or **▼** to scroll through 4 options: 0, 1, 2, and 3. Press **SAVE** (Left softkey) to save selection. Default = 0.
 - c. Press **3** to select key volume when a key is pressed: Use **▲** or **▼** to scroll through 3 options: High, Low, and Off. Press **SAVE** (Left softkey) to save selection. Default = Low.
 - d. Press **4** to select key tone: Use **▲** or **▼** to scroll through 4 options: 0, 1, 2, and 3. Press **SAVE** (Left softkey) to save selection. Default = 0.
5. Press **5** to change handset settings:
 - a. Press **1** to Group Select: see Handset Group Subscription.
 - b. Press **2** to clear phonebook:
 - i. Press **1** and confirm to delete the entire phonebook.
 - c. Press **3** to change the power-up LCD display to show, e.g., customer name or other greeting message:
 - i. Use **▲** or **▼** to move the cursor backward or forward to insert (to the left of the cursor) or delete (the character above the cursor, or left of the cursor if cursor is on the right of the last character).
 - ii. Enter characters using the Character Table and method discussed in the Phonebook section.
 - iii. When finished, press **SAVE** (Left softkey) to save change.
 - d. Press **4** to change LCD display contrast:
 - i. Use **▲** or **▼** to scroll through values 1 to 12. Pick one that is most suitable to you. Default = 10.
 - ii. Press **SAVE** (Left softkey) to save setting.

Advanced Operations

- e. Press **5** to change the LCD backlight:
 - i. Use **▲** or **▼** to scroll through options: On, Off, and 8 Seconds. Default = 8 seconds, meaning that the backlight is always on. The 8-second option will turn off the backlight after 8 seconds of inactivity.
 - ii. Press **SAVE** (Left softkey) to save setting.
- f. Press **6** to change Language:
 - i. Use **▲** or **▼** to scroll through options: English, Spanish, and French. Default = English, meaning the LCD display shows in English.
 - ii. Press **SAVE** (Left softkey) to save setting.
- g. Press **#** to turn Broadcast On/Off:
 - i. Press **ON** (Left softkey) to turn on the broadcast function (including the broadcast of handset to handset and base to handset).
 - ii. Press **OFF** (Right softkey) to turn off the broadcast function. Re: When broadcast setting "Off", there is an icon indicated in the display, side of the battery icon.
- h. Press ***** to make Reset Phone:
 - i. Press **1** to clear all setting and return to default (all phonebooks, CID logs, handset registration will be cleared).
 - ii. Press **2** to clear all setting but keep handset registration as well.
6. Press **6** to register or de-register handset: See Handset Registration.
7. Press **8** to add new bases:

From an administrator handset (Handset 10 or 11) to set new Base 01~07. Maximum additional bases is up to 8. Before adding a new base, the Handset must be registered in master base (Base ID =00).

 - a. Press **REG** button on new Base.
 - b. Use Handset 10 or 11 to Add base: Press **MENU** → **8** → **1**
 - c. Enter 01~07 (Base ID).
8. Press **9** to change system and Line setting: See system setting and Line Setting.

Technical Specifications

Electrical Specifications	Base Station	Portable Handset
Frequency	902-928 MHz	902-928 MHz
RF Power	Peak: 708 mW Average: 304 mW	Peak: 708 mW Average: 76 mW
Channel Spacing	200 kHz	200 kHz
Number of Channels	128	128
Modulation	GMSK	GMSK
Multiple Access	Frequency Hopping TDMA	Frequency Hopping TDMA
Frequency Hopping Rate	100 per second	100 per second
TDMA Frame Length	10 ms	10 ms
Number of Slots/Frame	8	8
Number of Users/Carrier	4	4
Receiver Sensitivity	< -108 dBm (@ BER 10 ⁻²)	< -108 dBm (@ BER 10 ⁻²)
Antenna Connector	Reverse TNC	Non-standard
Antenna Gain	2 dBi 6 dBi External (optional)	2 dBi (Long) 0.5 dBi (Short)
TX Power Control Range	NA	100-708 mW
Telephone Interface	RJ11 x 4	NA
Speech Coding	8 kbps G.729A	8 kbps G.729A
Channel Coding	8 kbps Convolutional + CRC	8 kbps Convolutional + CRC
Transmission Data Rate	170.678 kbps	176.678 kbps
User Data Rate	128 kbps duplex	128 kbps duplex
Duplex	Time Division Duplex (TDD)	Time Division Duplex (TDD)
Voice Quality	TIA/EIA-470B	TIA/EIA-470B
No. of System ID	65,536	65,536
Ring Signal	20-50 Hz, 12-90 Vrms	NA
Auto-Attendant Coding	8 kbps G.729	8 kbps G.729
Flash Time	100-900 ms programmable	NA
Power Source	120V/7V AC/DC Adapter	3.6V, 1700 mAh Li-ion Battery
Charger Current	NA	500 mA
Charge Time	NA	4 hours (from empty)
Regulation Compliance	FCC Part 15, Part 68	FCC Part 15, Part 68
Operating Temperature	-10 ~ 60°C	-10 ~ 60°C
Storage Temperature	-10 ~ 70°C	-10 ~ 70°C
Humidity	20 ~ 75 %	20 ~ 75 %
Dimension without antenna	280 x 215 x 53 mm 8.5 x 11.0 x 2.1 inch	161 x 58 x 31 mm 6.3 x 2.2 x 1.2 inch
Weight	907 grams	175 grams

Notes:

1. NA = Not Applicable.
2. The manufacturer reserves the right to change designs and specifications without notice.

Index

2

2-WAY/INTERCOM, 13, 15, 19, 34

3

3-Way Conferencing, 44, 45

A

Adjusting Receiver (Earpiece) Voice Volume, 38

Administrator Features, 22

Audio-in Jack, 22

Auto Attendant, 47, 48, 49

B

Base Select, 45

Base Station Features, 21, 22

Base Station Installation, 26

Battery, 5, 7, 11, 12, 13, 14, 15, 18, 25, 29, 30, 31, 38, 40, 59, 63, 65

Battery Recharge and Replacement, 40

Battery Strength, 14

BROADCAST, 13, 16, 30, 35, 36, 48, 49, 52, 53, 58, 59, 63

Broadcast through PBX, 52

Broadcasting a group of handsets, 35

Broadcasting all handsets, 35

Broadcasting an individual handset, 35

C

Call Conferencing, 20, 48

Call Forwarding, 19, 45, 46, 56

Call Hold, 18

Call in-progress, 14, 40

Call Timer, 19

Call Transfer, 19, 23, 38, 44, 58

Call Waiting, 15, 17, 27, 46, 47

Call Waiting with Caller ID, 17

Caller ID, 17, 18, 27, 37, 40, 56

Cardiac Pacemaker, 4

Charger Features, 24, 25

D

DC In: Jack, 22

De-registration, 41, 42, 43, 49

Dialing Prefix, 18, 56

DND, 17

Do Not Disturb (Silent Ring), 39

E

emergency, 4

Ending a Call, 38

Equipment Checklist, 11, 12

Expanding coverage, 27

Expanding capacity, 28

External telephone answering device, 26

F

FCC, 5, 8, 9, 65

FDA, 4, 5

G

Group ID, 15, 16, 19, 35, 47, 51, 53, 58, 59, 64

H

Handset and Charger
Installation, 29

Handset Charging Slot, 24, 25

Handset Features, 13, 14, 15, 16, 17, 18, 19, 20

Handset Group Subscription, 43, 56, 62

Index

Handset ID, 14, 15, 18, 19, 22,
30, 35, 36, 37, 41, 42, 43, 44,
45, 49, 51, 53, 58, 59, 64

Handset Registration, 28, 29,
41, 59, 63

Handset to Handset Calls, 34

Headset Jack, 13

Hearing Aid Users, 4

I

IC, 8

IDLE mode, 15, 30

Intercom in-progress, 14

interference, 4, 5, 7, 8, 9, 29, 52, 58

K

Key Guard, 39, 55, 62

Key-guard, 18

L

Line Dedication, 47, 49

Line Indicator, 14

Line Selection, 20, 47, 57

Lithium-Ion (Li-Ion), 7

M

Making a 2-Way/ Intercom Call, 34

Making a Broadcast, 35

Making a Telephone Call, 34

MENU mode, 30

Multi-base setups, 27

Multiple handsets registration, 16

Mute, 18, 39

N

Name Tagging, 17

O

outdoor antenna, 12, 21, 22

P

PBX option, 20, 57, 58

PBX option transfer, 20

Phonebook, 14, 18, 49, 50, 51,
52, 55, 57, 59, 62, 63

Placing a Call On Hold, 38

Power Outage, 5

R

Receiving a Telephone Call, 36

Receiving an Intercom Call, 37

Redial, 17, 36, 56

Registration, 8, 22, 28, 29, 30,
31, 41, 42, 43, 49, 59, 63

Registration Key, 22

REGISTRATION mode, 22, 30,
41, 42

Regulatory Information, 8

REN, 8

Reset Button, 22

Restores base station to factory
settings, 22

Reverse thread connector, 21

Ringer / Vibrator, 15, 16, 36, 37,
39, 56, 62

RSSI, 14

S

Safety Instructions, 4, 5, 7

Spare Battery Charging Slot,
24, 25

Speaker phone, 14, 15, 34,
35, 37

Speed dial, 34

Index

T

- TALK mode, 16, 30
- TALK/SPEAKERPHONE, 15
- Technical Specifications, 65
- Text Envelope, 14
- Text Messaging, 14, 19, 59, 60, 63, 64
- Three Call Logs, 17, 55, 57
- To Call back from Call Log, 40
- To View Missed Call(s), 39
- Transformer, 26, 29
- Two-Digit Address Index, 14, 55

V

- Vibrator, 16
- Volume, 16, 19, 30, 38, 39, 59, 60, 64

W

- Wall mounted, 31



EnGenius[®]