

Mitel MiVoice 6940 IP Phone

RELEASE 1.6 USER GUIDE FOR MIVOICE BUSINESS

58016432 REV00

April, 2021



Notice

The information contained in this document is believed to be accurate in all respects but is not warranted by **Mitel Networks™ Corporation (MITEL®)**. The information is subject to change without notice and should not be construed in any way as a commitment by Mitel or any of its affiliates or subsidiaries. Mitel and its affiliates and subsidiaries assume no responsibility for any errors or omissions in this document. Revisions of this document or new editions of it may be issued to incorporate such changes. No part of this document can be reproduced or transmitted in any form or by any means - electronic or mechanical - for any purpose without written permission from Mitel Networks Corporation.

Trademarks

The trademarks, service marks, logos and graphics (collectively "Trademarks") appearing on Mitel's Internet sites or in its publications are registered and unregistered trademarks of Mitel Networks Corporation (MNC) or its subsidiaries (collectively "Mitel") or others. Use of the Trademarks is prohibited without the express consent from Mitel. Please contact our legal department at legal@mitel.com for additional information. For a list of the worldwide Mitel Networks Corporation registered trademarks, please refer to the website: <http://www.mitel.com/trademarks>.

®, ™ Trademark of Mitel Networks Corporation
© Copyright 2021, Mitel Networks Corporation
All rights reserved

Software License Agreement

Mitel, hereinafter known as "Seller", grants to Customer a personal, worldwide, non-transferable, non-sublicenseable and non-exclusive, restricted use license to use Software in object form solely with the Equipment for which the Software was intended. This Product may integrate programs, licensed to Mitel by third party Suppliers, for distribution under the terms of this agreement. These programs are confidential and proprietary, and are protected as such by copyright law as unpublished works and by international treaties to the fullest extent under the applicable law of the jurisdiction of the Customer. In addition, these confidential and proprietary programs are works conforming to the requirements of Section 401 of title 17 of the United States Code. Customer shall not disclose to any third party such confidential and proprietary programs and information and shall not export licensed Software to any country except in accordance with United States Export laws and restrictions.

Customer agrees to not reverse engineer, decompile, disassemble or display Software furnished in object code form. Customer shall not modify, copy, reproduce, distribute, transcribe, translate or reduce to electronic medium or machine readable form or language, derive source code without the express written consent of the Seller and its Suppliers, or disseminate or otherwise disclose the Software to third parties. All Software furnished hereunder (whether or not part of firmware), including all copies thereof, are and shall remain the property of Seller and its Suppliers and are subject to the terms and conditions of this agreement. All rights reserved.

Customer's use of this software shall be deemed to reflect Customer's agreement to abide by the terms and conditions contained herein. Removal or modification of trademarks, copyright notices, logos, etc., or the use of Software on any Equipment other than that for which it is intended, or any other material breach of this Agreement, shall automatically terminate this license. If this Agreement is terminated for breach, Customer shall immediately discontinue use and destroy or return to Seller all licensed software and other confidential or proprietary information of Seller. In no event shall Seller or its suppliers or licensors be liable for any damages whatsoever (including without limitation, damages for loss of business profits, business interruption, loss of business information, other pecuniary loss, or consequential damages) arising out of the use of or inability to use the software, even if Seller has been advised of the possibility of such damages.

Contents

Welcome	1
About this guide	1
What's New	1
Supporting documentation	2
Phone features	2
Installation and setup	2
Cleaning the Mitel MiVoice 6940 IP phone touchscreen	2
Tips for your comfort and safety	3
Don't cradle the handset	3
Protect your hearing	4
Adjust the viewing angle	4
Phone keys	5
Key panel	5
Key description	6
Input methods	7
Dialpad keys	7
On-screen keyboard	9
Getting started	11
UI overview	11
Navigation	11
Home screen	11
Phone and network status indicators	12
Programmable keys, state-sensitive softkeys, and the prime line key	14
Call screen	15
Customizing your phone	17
Using the Settings menu	18
Status	19
Language	22

Call Forward24
Bluetooth26
Enabling Bluetooth functionality26
Pairing a Bluetooth device27
Forgetting a Bluetooth device30
Disconnecting a connected Bluetooth device32
Renaming a paired Bluetooth device34
Connecting to a different or disconnected Bluetooth device35
Audio37
Ring Tones37
Audio Path38
Headset39
Display40
Voice Services42
Manual Upgrade44
Diagnostics45
Audio Diagnostics45
Ping47
TCP DUMP48
DHCP Trace50
Wi-Fi52
Connecting to a Wi-Fi network53
Restart56
Configuring and using programmable keys58
PKM LED Indicator59
Speed Call59
Other Features60
Phone Lock60
Call Forward Always61
Do Not Disturb63
Mobile/PC Line65
Account codes66
Account Code Verified68
Float Keys69
Using Float Keys70
Making calls71
Dialing a number71
Initiating a callback71
Redialing a number72
Receiving calls73
Answering an incoming call73
Manually forwarding an incoming call74

Handling calls	75
Placing a call on hold	.75
Muting the microphone	.75
Transferring a call	.76
Creating a multi-party conference call	.77
Ending a conference and transferring remaining parties	.80
Ending calls	.80
Managing calls	81
Contacts	.81
General functions	.82
Performing a search	.83
Dialing from the Contacts application	.85
Personal folder features	.86
Adding a new contact to your Personal folder	.87
Editing an existing contact in your Personal folder	.88
Deleting all contacts from the Personal folder	.89
Deleting a contact from the Personal folder	.91
Corporate and Mobile folder features	.92
Performing a search on a non-cached Corporate contact folder	.93
Copying a Corporate or Mobile contact to the Personal folder	.95
Call History	.97
Deleting entries from the Call History application	.99
Copying entries to the Personal folder in the Contacts application	103
Missed calls indicator	.104
Voicemail	.105
Visual voicemail	.107
Enabling voicemail application	.108
Logging into your voicemail	.109
Logging out of your voicemail	.110
Playing a voicemail	.110
Dialing a voicemail	.111
Deleting a voicemail	.113
Saving a voicemail	.114
Sending voicemail to a number	.114
Adding voicemail number to Contacts	.116
Emailing a voicemail	.118
MobileLink	.120
Pairing a mobile phone using Bluetooth	.121
Syncing mobile contacts	.121
Syncing mobile call history	.123
Viewing mobile call history	.124
Viewing mobile missed calls	.125
Viewing details of a mobile call history or missed call entry	.125

Updating mobile call history and missed calls	127
Dialing a mobile phone call history entry	127
Adding an entry to Contacts	129
Deleting mobile call history and missed call	130
Answering an incoming mobile call using your Mitel MiVoice 6940 IP phone	
132	
Moving audio from an active mobile call between your mobile phone and Mitel	
MiVoice 6940 IP phone	132
PCLink for 6940 IP Phone	133
Configure the Mitel 6940 IP Phone	134
Pair the Mitel 6940 IP Phone with Windows or MAC	135
Configure Collaboration Applications	138
Understanding IP Phone Call Behavior with PCLink	139
Known Issues With Tested Video Collaboration Applications	141
Additional features142
Accessory support152
Mitel M695 Programmable Key Module (PKM)	152
Mitel Wireless LAN Adapter	153
Mitel Cordless Bluetooth Handset	154
Hardware features	155
LED indicator	156
Alerting tones	157
Powering on/off the Bluetooth cordless handset	157
Mitel Integrated DECT Headset	158
Features	158
Using the headset	159
Charging the headset	159
Upgrading the headset	159
Check the battery level and firmware version of the Integrated DECT Head-	
set	160
LED status	161
Replacing the Integrated DECT Headset	161
Mitel S720 Bluetooth Speakerphone	162
Hardware features	162
USB headsets	164
Limited warranty166
Exclusions	166
Warranty repair services	166
After warranty service	167

Welcome

The Mitel MiVoice 6940 IP phone is a top-of-the-line executive phone with a large high-resolution touch display that delivers graphically rich applications. As a full-feature enterprise-class phone, the Mitel MiVoice 6940 IP phone provides 96 programmable self-labeling keys and six intuitive state sensitive softkeys.

The Mitel MiVoice 6940 IP phone features superior sound quality with a cordless Bluetooth handset featuring enhanced audio capabilities, a speakerphone that utilizes advanced audio processing to achieve richer and clearer handsfree conversations, and native Bluetooth and USB headset functionality.

The 6940 IP phone supports MobileLink, a feature that provides seamless mobile integration using Bluetooth wireless technology. MobileLink highlights include the ability to:

- Answer a mobile phone call using your Mitel MiVoice 6940 IP phone.
- Effortlessly move mobile call audio between the Mitel MiVoice 6940 IP phone and your mobile phone.
- Sync your mobile phone's contact list with your Mitel MiVoice 6940 IP phone.

Accommodating today's high speed networks through dual Gigabit Ethernet ports, the Mitel MiVoice 6940 IP phone also offers plenty of support for Mitel and third-party peripherals and has an environmentally efficient PoE class 3 rating. The Mitel MiVoice 6940 IP phone is one of the most advanced desktop IP phones available on the market today and is ideal for any enterprise executive or manager, Teleworker, and Contact Center employee.

The 6940 IP phone is compatible with the MiVoice Business phone system.

About this guide

This guide explains how to use the basic features of your new Mitel MiVoice 6940 IP phone. Not all features listed are available by default. Your System Administrator has the ability to customize many features on this phone. Contact your System Administrator to find out which features and services are available to you on your phone system.

What's New

This section describes the new features or enhancements in MiNet Release 1.6.0.

The following table summarizes each new feature or enhancement and provides a link to more information about the feature.

FEATURE/ENHANCEMENT	DESCRIPTION	LOCATION
PC Audio over Bluetooth	Mitel 6940 IP phone is used as the audio device for PC video conference on all the supported video conference applications, for both Windows and Mac through the IP Phone's Bluetooth interface.	PCLink for 6940 IP Phone

Supporting documentation

1. Access document within Mitel Document Centre at <https://www.mitel.com/document-center>.
2. Click **DEVICES AND ACCESSORIES**.
3. Navigate to **IP PHONES > 6900 SERIES > 6900 IP PHONES** and select the required document.

Phone features

Feature highlights include:

- 7" WVGA (800x480) color TFT capacitive touch-screen LCD display with brightness controls
- Built-in-two-port, 10/100/1000 Gigabit Ethernet switch
- Embedded Bluetooth 4.0
- USB 2.0 port (500mA maximum)
- Cordless Bluetooth handset
- Enhanced wideband, full-duplex speakerphone for handsfree calls
- Extensive support for peripherals and modules: Mitel S720 Bluetooth Speakerphone, Mitel Cordless Bluetooth Handset, Mitel Integrated DECT, USB, and Bluetooth headsets, M695 Color Programmable Key (PKM) modules, and Mitel Wireless LAN Adapter
- AC power adapter (sold separately)
- 96 programmable, multi-function, self-labeling keys and six intuitive state sensitive softkeys
- MobileLink support - seamless mobile integration using Bluetooth wireless technology

Installation and setup

Please refer to the *Mitel MiVoice 6940 IP Phone Installation Guide* included with your phone for basic installation and physical setup information.

Cleaning the Mitel MiVoice 6940 IP phone touchscreen

Repeated use of the Mitel MiVoice 6940 IP phone may lead to a dirty screen. To clean the phone's screen, Mitel recommends the use of a super fine cotton cloth, cotton swab, or microfiber lens cloth made of

microfiber suede (preferably one without sewn hems or similar characteristics that would scratch the surface of the screen). You can use the cloth dry for dusting, polishing and light cleaning, or dampen it (with water only) to deep clean the surface. If using a damp cloth, make sure to use just a little water on the cloth. Too much moisture can cause damage to your phone that could be permanent. If the cloth is dripping or the surface shows water spots after wiping, then you are using too much water on the cloth.

Some rules to follow when cleaning your screen include:

- Do not use any sharp objects including your fingernail.
- Do not rub, touch or tap the surface of the screen with sharp or abrasive items such as a ball-point pen or a screw driver.
- Do not use any type of cleansers including abrasive cleansers.
- Do not use any type of glass cleaner or any cleaner that contains alcohol or ammonia.
- Do not spray any type of cleaner directly on the phone's screen.
- Do not allow any liquid to run down the surface of the touchscreen and under the bezel.
- If using a damp cloth, disconnect power to the phone before wiping the screen.

CAUTION: Use of any type of cleaners, alcohol, ammonia, and/or hard or sharp objects can harm the touchscreen surface and potentially cause transparent conductive film cracks in the screen.

To clean your Mitel MiVoice 6940 IP phone's touchscreen:

1. Disconnect power to your phone.
2. Retrieve a soft cloth, such as a microfiber cloth.
3. If necessary, dampen the cloth. For regular cleanings, a dry cloth is usually sufficient. For stubborn build-up or for periodic deep cleanings, wet the cloth under a faucet and then wring out until it is just damp.
4. Wipe the screen gently with the cloth making sure to not get any moisture in the sides of the screen. You can also wipe down the entire phone to remove dirt and grime.
5. Allow your phone to completely dry after you are done cleaning. This should only take a few minutes.
6. Reconnect power to your phone.

NOTE: Keeping your touchscreen clean and free of dirt and fingerprints on a regular basis extends the life of your phone's touchscreen.

Tips for your comfort and safety

Don't cradle the handset

Prolonged use of the handset can lead to neck, shoulder, or back discomfort, especially if you cradle the handset between your ear and shoulder. If you use your phone a lot, you may find it more comfortable to use a headset. See "[Accessory support](#)" for more information on headsets.

Protect your hearing

Your Mitel MiVoice 6940 IP phone has a control for adjusting the volume of the handset, headset, and speakerphone. Because continuous exposure to loud sounds can contribute to hearing loss, keep the volume at a moderate level.

Adjust the viewing angle

The stand for your Mitel MiVoice 6940 IP phone supports two viewing angles (30° and 60°). Adjust the stand to suit your viewing preference. For instructions on how to adjust the stand, see the *Mitel MiVoice 6940 IP Phone Installation Guide*.

Phone keys

Key panel

The following sections describe the various Mitel MiVoice 6940 IP phone key functions and how they can help you make and manage your calls and caller information.

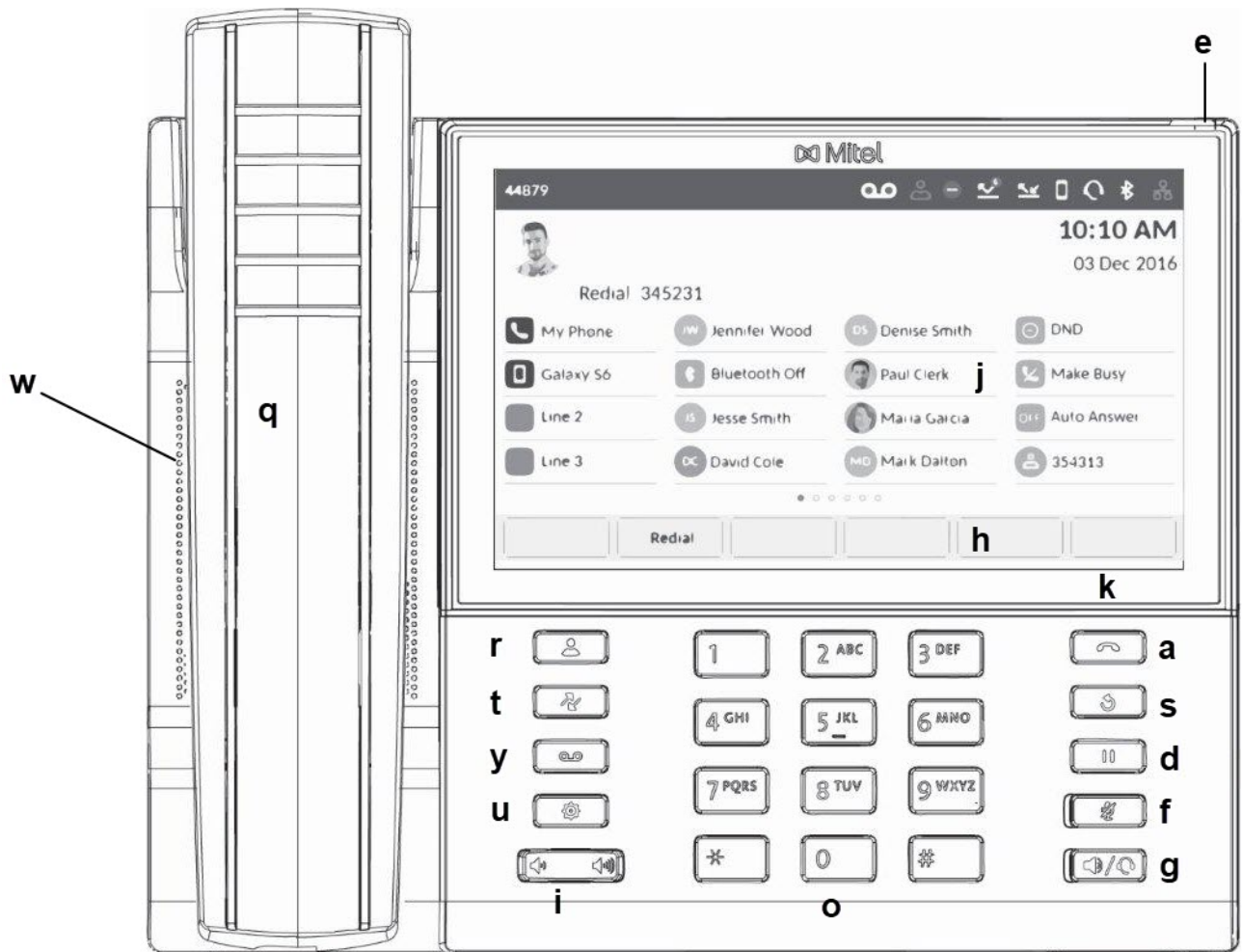







a	Goodbye Key	o	Dialpad
d	Hold Key	q	Bluetooth Cordless Handset
e	Message Waiting Indicator (MWI)	r	Contacts Key
f	Mute Key	s	Redial Key
g	Speaker/Headset Key	t	Call History Key

h	State-Sensitive Softkeys	u	Settings Key
i	Volume Control	w	Speaker
j	Programmable Keys	y	Voicemail Key
k	LCD Touchscreen		

Key description

The following table describes the keys on the Mitel MiVoice 6940 IP phone:

Key	Description
	Contacts key - Displays a list of your contacts. For more information, see “Contacts” .
	Call History key - Displays a list of your missed, outgoing, and answered calls. For more information, see “Call History” .
	Voicemail key - Provides access to your voicemail service (if configured). For more information, see “Voicemail” .
	Settings key - Provides services and settings that allow you to customize your phone. For more information, see “Customizing your phone” .
	Volume controls - Adjusts the volume for the ringer, handset, headset, and speakerphone. Press the volume control keys while the phone is ringing to adjust the ringer volume. Pressing these keys during an active call adjusts the volume of the audio device being used (handset, headset, or speaker).
	Goodbye key - Ends an active call. The Goodbye key also exits an open list (such as Call History) and menus (such as the Settings menu) without saving changes.
	Redial key - Displays a list of your previously dialed calls. Pressing the Redial key twice redials the last dialed number displayed on the Home screen. For more information, see “Redialing a number” .

	Hold key - Places an active call on hold. To retrieve a held call, tap the applicable Line key. For more information, see “Placing a call on hold” .
	Mute key - Mutes the microphone so that your caller cannot hear you (the LED beside the key turns on when the microphone is on mute). For more information, see “Muting the microphone” .
	Speaker/Headset key - Transfers the active call to the speaker or headset, allowing handsfree use of the phone. For more information, see “Audio Path” .

Input methods

Dialpad keys

The Mitel MiVoice 6940 IP phone has a dialpad with digits from 0 through 9, a * key, and a # key. Keys 2 through 9 contain the letters of the alphabet. These dialpad keys can be used to dial a phone number to make a call (see [“Making calls”](#)) and to press keys requested by an Interactive Voice Response (IVR) system. The basic inputs for the Mitel MiVoice 6940 IP phone dialpad includes the following:

Dialpad Key	Description
0	Dials 0
1	Dials 1
2 ABC	Dials 2 When entering text, this key enters A with one press, B with two presses, and C with three presses.
3 DEF	Dials 3 When entering text, this key enters D with one press, E with two presses, and F with three presses.
4 GHI	Dials 4 When entering text, this key enters G with one press, H with two presses, and I with three presses.

Dialpad Key	Description
5 JKL	Dials 5 When entering text, this key enters J with one press, K with two presses, and L with three presses.
6 MNO	Dials 6 When entering text, this key enters M with one press, N with two presses, and O with three presses.
7 PQRS	Dials 7 When entering text, this key enters P with one press, Q with two presses, R with three presses, and S with four presses.
8 TUV	Dials 8 When entering text, this key enters T with one press, U with two presses, and V with three presses.
9 WXYZ	Dials 9 When entering text, this key enters W with one press, X with two presses, Y with three presses, and Z with four presses.

The * is called the star key. The # is called the pound key, number sign, or hash key, depending on one's nationality or personal preference. These can be used for special functions such as accessing advanced services. The star key and pound key functions are dependent on your call server's feature availability. Contact your System Administrator for more information about available functions using these keys.

When entering characters in the various **Settings** menus or in different applications (for example, when adding a contact to your **Contacts** application), advanced characters can be entered using the dialpad keys.

The following tables identifies the characters that you can use and the order in which they are accessible.

Key	Uppercase Characters	Lowercase Characters
0	0 +	0 +
1	1 . : ; = _ , - ' & () \$!	1 . : ; = _ , - ' & () \$!
2	A B C 2	a b c 2
3	D E F 3	d e f 3
4	G H I 4	g h i 4
5	J K L 5	j k l 5
6	M N O 6	m n o 6
7	P Q R S 7	p q r s 7

Key	Uppercase Characters	Lowercase Characters
8	T U V 8	t u v 8
9	W X Y Z 9	w x y z 9
*	* <SPACE>	* <SPACE>
#	# / \ @	# / \ @

On-screen keyboard

In addition to the Mitel MiVoice 6940 IP phone’s dialpad keys, an on-screen international keyboard is available for character input. The on-screen international keyboard automatically displays in various applications when character input is required.

The lower case layout of the on-screen international keyboard is as follows:

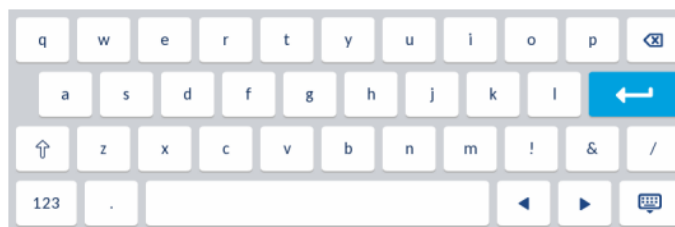

The upper case layout of the on-screen international keyboard is as follows:

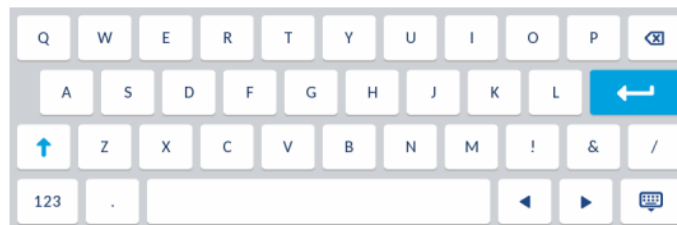

The numeric layout of the on-screen international keyboard is as follows:



Pressing and holding various keys on the on-screen keyboard allows you choose diacritical and secondary characters. The diacritical and secondary characters available for the on-screen international keyboard include:

Press and hold	Available diacritics/secondary characters

e	è	é	ê	ë	ē	ě	é	
u	ù	ú	û	ü				
i	ì	í	î	ï	ī	ı		
o	ò	ó	ô	õ	ö	œ	ø	
a	à	á	â	ã	ä	å	æ	ā
c	ç	ć	č					
l	ł							
n	ñ	ń						
y	ÿ							
s	ß							
!	ı							
?	¿							
\$	€	£						
({	[<					
)	}]	>					
`	~							
=	+							
/		\						
-	—							

Getting started

The Mitel MiVoice 6940 IP phone must be set up and be configured by the System Administrator prior to its first use.

UI overview

Navigation

UI navigation is performed using the LCD touchscreen:

- Press and hold a programmable key to configure the programmable key (see [“Configuring and using programmable keys”](#) for more information).
- Swipe left and right in the programmable key area to switch programmable key pages.
- Swipe up and down in the various settings menus as well as the **Contacts** and **Call History** applications to scroll through the respective list of values, contacts, and entries.
- Tap an item on screen to select the item or perform an action.

Home screen

When the phone has successfully booted up and connected to the network, the phone displays the **Home** screen. The **Home** screen shows the date and time along with your number and last dialed number. It is the default screen displayed when the phone is in an idle state.

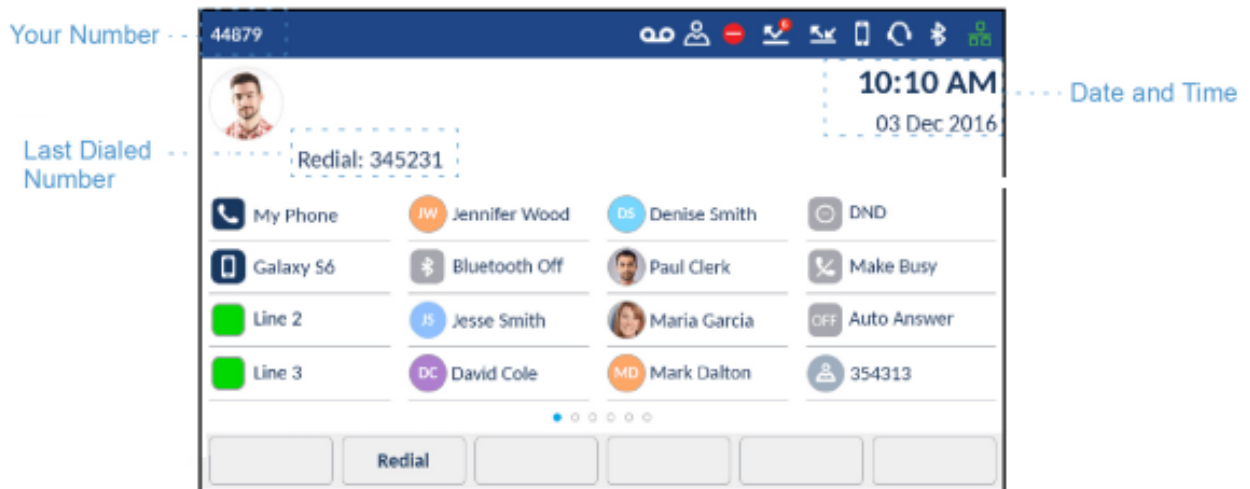

NOTE:

1. Your System Administrator should have configured your number and any other administrative features required. If your number does not display on the screen, contact your System Administrator.
2. Avatars are only available if set up by your System Administrator. If avatars are not available, contact's initials (if available) or a generic avatar is displayed.







Phone and network status indicators





There are icons that display on the phone to indicate the status of the phone and network. These icons display on the upper right corner of the **Home** screen.



The following table identifies and describes the phone and network status indicators on the **Home** screen.

Icon	Description
	Network Connected - The Network Connected icon displays on the Home screen when the phone is connected to the MiVoice Business call server.
	Attempting Network Connection - The Attempting Network Connection icon displays on the Home screen when the phone is attempting to connect to the MiVoice Business call server.
	Network Disconnected - The Network Disconnected icon displays on the Home screen when the phone loses connection to the MiVoice Business call server. If this icon is displayed and you are using an AC adapter for power, check that the Ethernet cable is tightly connected to the phone and to the network device port. The phone should automatically detect when it is reconnected and attempt to connect to the network. If this does not resolve the issue, check with your System or Network Administrator for assistance.

Icon	Description
	<p>Bluetooth Enabled - The Bluetooth Enabled icon displays on the Home screen when Bluetooth functionality has been turned on. For more information on Bluetooth functionality, see "Bluetooth".</p>
	<p>Headset Connected - The Headset Connected icon displays on the Home screen when a headset (Integrated DECT Headset, Bluetooth, or USB) connection has been detected. For more information on headset functionality, see "Bluetooth" and "Mitel Integrated DECT Headset".</p>
	<p>Mobile Phone Connected - The Mobile Phone Connected icon displays on the Home screen when a mobile phone connection has been detected. For more information on mobile integration features, see "Bluetooth".</p>
	<p>Speakerphone Connected - The Speakerphone Connected icon displays on the on the Home screen when a speakerphone connection has been detected. For more information on mobile integration features, see "Bluetooth".</p>
	<p>Call Forward Always - The Call Forward Always icon displays on the Home screen when the Call Forward feature is enabled using the "Always" condition (as opposed to the "Busy" and "No Answer" conditions). For more information on the Call Forward feature, see "Call Forward".</p>
	<p>Missed Calls - The Missed Calls icon displays on the Home screen only when incoming calls have not been received. The number in the red badge indicates how many calls were missed. To access a list of your missed calls, press the  (Call History) key. For more information on missed calls, see "Missed calls indicator".</p>

Icon	Description
	<p>Do Not Disturb - The Do Not Disturb (DND) icon displays on the Home screen when the DND feature is enabled. When DND is enabled, callers calling into the phone may hear a DND signal and a "Do Not Disturb" message is displayed on their phones, depending on the setting in the System Administrator Tool.</p> <p>For more information on the DND feature, see "Do Not Disturb".</p>
	<p>Hotdesk User - The Hotdesk User icon displays on the Home screen when you log in using your hotdesk account.</p>
	<p>Voicemail - The Voicemail icon displays on the Home screen only if you have new messages waiting. To access your voicemail messages, press the  (Voicemail) key.</p> <p>For more information on voicemail functionality, see "Voicemail".</p>

Programmable keys, state-sensitive softkeys, and the prime line key

16 programmable keys (including the **Prime Line** key) and five state-sensitive softkeys are always displayed on the **Home** screen. The programmable keys allow you to configure up to 96 different features (such as speed calls, phone lock, DND, and so on).

NOTE: If enabled by your System Administrator, certain features can be programmed on the programmable keys by pressing and holding the respective programmable key. Others can only be programmed by your System Administrator through the MiVoice Business call server. See ["Configuring and using programmable keys"](#) for information on how to program the programmable keys using the phone. Contact your System Administrator for details on what features are available to be programmed through the MiVoice Business call server.

The state-sensitive softkeys change depending on the state of the phone and are used to perform different functions when the phone is in an idle, connected, outgoing, or busy state.

The **Prime Line** key is a visual indication of the status of your prime line. When your phone is in an idle

state, your  (**Prime Line**) icon is solid blue. Your System Administrator may also have configured additional line appearances on your phone. Line appearance keys are solid green when your phone is in an idle state.

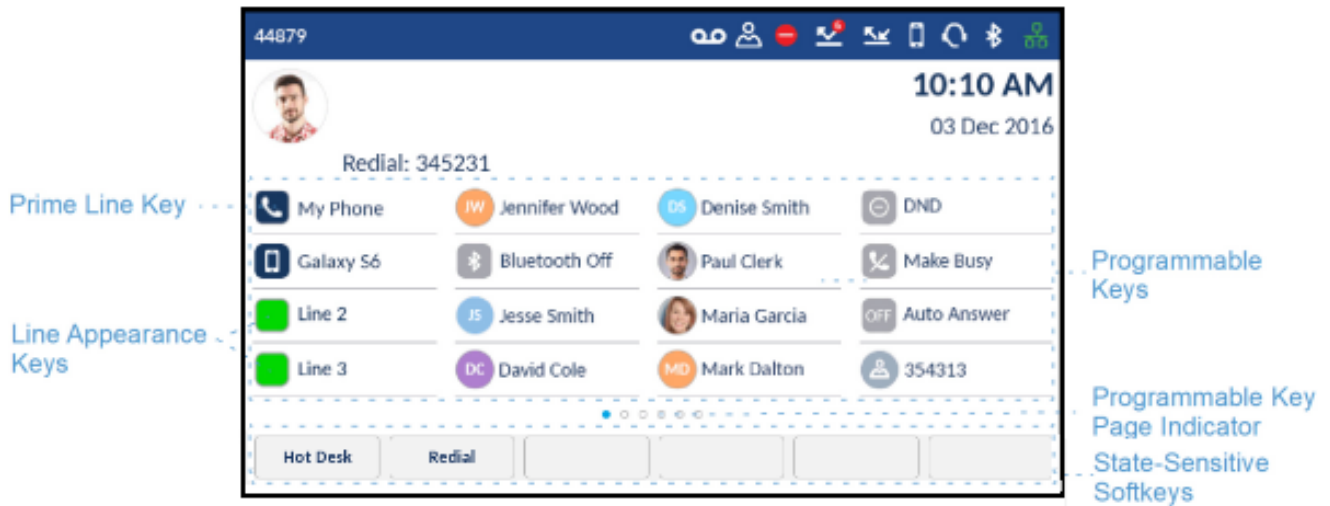



If you have 16 or more programmable keys configured, programmable page indicators are displayed at the bottom of the screen. These dots indicate the number of programmable key pages and its relative position. Swipe left and right on the programmable key area to switch the programmable key pages.

Call screen



During an incoming or outgoing call and when on an active call, all the essential information regarding the call is displayed on screen, including the caller’s avatar, name, number, and call duration timer. The context-sensitive softkeys also change allowing you access to more call handling features (such as **Transfer** and **Add User** during an active call).



Additionally, if the call is on the **Prime Line** key, the **Prime Line** key changes to reflect the status of the line as per the following table.















Icon	Description
	(Blinking) Indicates the prime line is ringing due to an incoming call.
	Indicates the prime line is busy.
	(Blinking) Indicates the call on the prime line is on hold.





If the call is on a different line, the applicable line appearance key change to reflect the status of the line as per the following table.

Icon	Description
	(Blinking) Indicates the applicable line is ringing due to an incoming call.
	Indicates the applicable line is busy.
	(Blinking) Indicates the call on the applicable line is on hold.

Customizing your phone

You can customize your phone and view your phone status by pressing the  (**Settings**) key, opening the **Settings** menu. This menu provides a single location to access all your phone settings. The following phone settings can be configured through the **Settings** menu:

Icon	Option
	Status
	Language
	Voicemail
	Call Forward
	Voice Services
	Diagnostics
	<ul style="list-style-type: none"> • Audio Diagnostics
	<ul style="list-style-type: none"> • Ping
	<ul style="list-style-type: none"> • TCP DUMP
	<ul style="list-style-type: none"> • DHCP Trace
	Bluetooth
	Wi-Fi
	Audio
	<ul style="list-style-type: none"> • Ring Tones

Icon	Option
	<ul style="list-style-type: none"> • Audio Feedback
	<ul style="list-style-type: none"> • Audio Path
	Display
	Restart

NOTE:

1. The **Advanced** options are Administrator-level functions only, and are not accessible by the user. These options should only be set up and changed by your System Administrator.
2. The **Log Issue** softkey is used to generate a log file that can help Administrators debug issues. You should only tap this softkey when requested by your System Administrator.

Using the Settings menu

1. Press the  (**Settings**) key on the phone to enter the **Settings** menu.

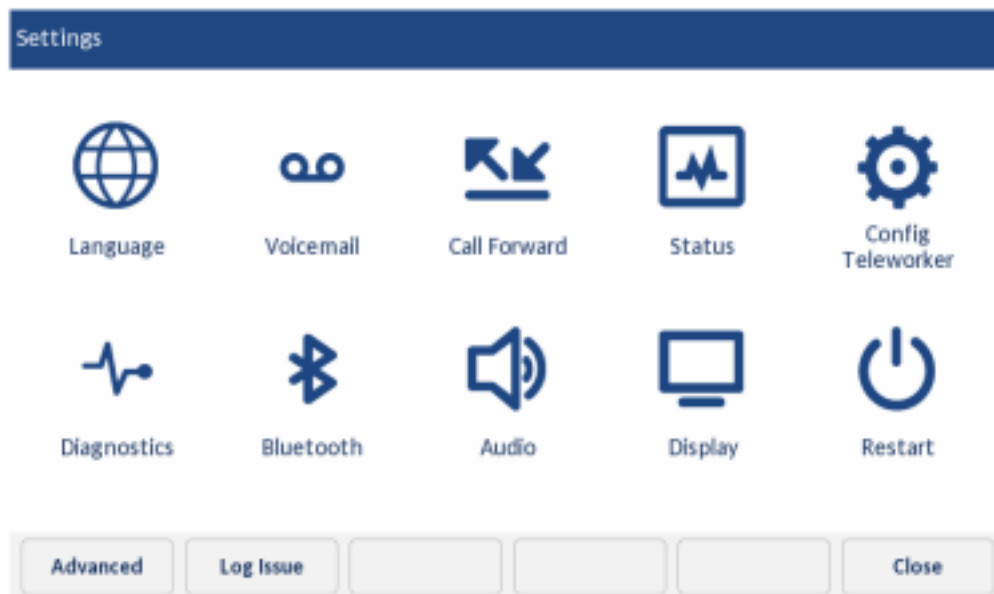

2. Tap the applicable icon to enter the respective settings menu.
3. Swipe up and down to scroll through available lists and tap an on-screen item to select the item.
4. Use the dialpad keys or the on-screen keyboard to enter characters.

5. Tap the **Save** softkey to save your changes.
6. Press the  (**Goodbye**) key or tap the **Close** softkey at any time to exit without saving changes.

NOTE: For more information about **Advanced** options, contact your System Administrator.

Status

The **Status** settings in the **Settings** menu allows you to view your phone's:

- **Network General Info:**
General information regarding your phone's network settings such as IP address, subnet mask, gateway, MAC address, call server IP addresses, TFTP server IP address and port, IPA IP address, and DNS values.
- **Network Persistent Data:**
The IP addresses for call servers 1 to 4.
- **Network DHCP Info:**
Information regarding your phone's Dynamic Host Configuration Protocol (DHCP) status and T1/T2 renewal times.
- **Network Status QoS:**
:Information regarding Quality of Service (QoS) features such as Virtual LAN (VLAN), Layer 2 Priority (L2P), and Differentiated Services Code Point (DSCP).
- **Port Info:**
Speed and duplex values for both the LAN and PC ports.
- **Phone Info:**
General phone-related information such as model number, hardware and call server revisions, main firmware version, and boot version.

NOTE: Tap the **Copyright** softkey to view copyright information.

To view the **Status** menu:

1. Press the  (**Settings**) key on the phone to enter the **Settings** menu.
2. Tap the **Status** icon.
3. Tap the status category to view the status details and swipe up and down to scroll through any available lists.

The following status items are available to view:

- Network General Info

Status		
Network General Info	DHCP Status	DISABLED
Network Persist. Data	T1 (Seconds)	0
Network DHCP Info	T2 (Seconds)	0
Network QoS		
Port Info		
Phone Info		
<input type="button" value=""/> <input type="button" value=""/> <input type="button" value=""/> <input type="button" value=""/> <input type="button" value=""/> <input type="button" value="Cancel"/>		

– Network Static QoS

Status		
Network General Info	VLAN Id	-1 ()
Network Persist. Data	L2P Default	6
Network DHCP Info	L2P Voice	6
Network Static QoS	L2P Signaling	3
Port Info	L2P Other	0
Phone Info	DSCP Default	46
	DSCP Voice	46
<input type="button" value=""/> <input type="button" value=""/> <input type="button" value=""/> <input type="button" value=""/> <input type="button" value=""/> <input type="button" value="Cancel"/>		

– Port Info

Status		
Network General Info	LAN Port Speed	1000M
Network Persist. Data	LAN Port Duplex	Full_Duplex
Network DHCP Info	PC Port Speed	No Link
Network Static QoS	PC Port Duplex	No Link
Port Info		
Phone Info		
<input type="button"/> <input type="button"/> <input type="button"/> <input type="button"/> <input type="button"/> <input type="button"/> <input type="button"/>		

– Phone Info

Status		
Network General Info	Main Version	01.04.00.060
Network Persist. Data	Call Server Rev.	14.0.3.35
Network DHCP Info	DECT Headset Version	1.11.0 1.11.0 2.28.0 96%
Network QoS	DECT Power/Bandwidth	Normal / Narrowband
Port Info	Model	MINET_6940 Rev: A18
Phone Info	Phone Uptime	21:23:34:22
<input type="button"/> <input type="button"/> <input type="button"/> <input type="button"/> <input type="button"/> <input type="button"/> <input type="button"/>		

- To view further information on the selected status item, tap the screen on the right and swipe up and down to scroll through the status items.

Language

The Mitel MiVoice 6940 IP phone supports the following languages:

- English
- French

- German
- Spanish
- Spanish (Latin America)
- Portuguese
- Portuguese (Brazil)
- Dutch
- Italian
- Romanian
- Russian
- Swedish
- Polish

When you set the language on the phone, all on-screen text (in idle/call screens, setting menus, and applications) displays in the selected language.

NOTE:

1. All languages may not be available for selection as availability is dependent on the language files provided by the MiVoice Business call server. Contact your System Administrator for details on what languages are available in your specific environment.
2. Unofficially supported languages may be available for selection on your phone depending on the language files available on the MiVoice Business call server. If available, these languages can be used by selecting Local 1 or Local 2 in the **Language** menu.

To specify the language in which on screen text displays:

1. Press the  (**Settings**) key on the phone to enter the **Settings** menu.
2. Tap the **Language** icon.

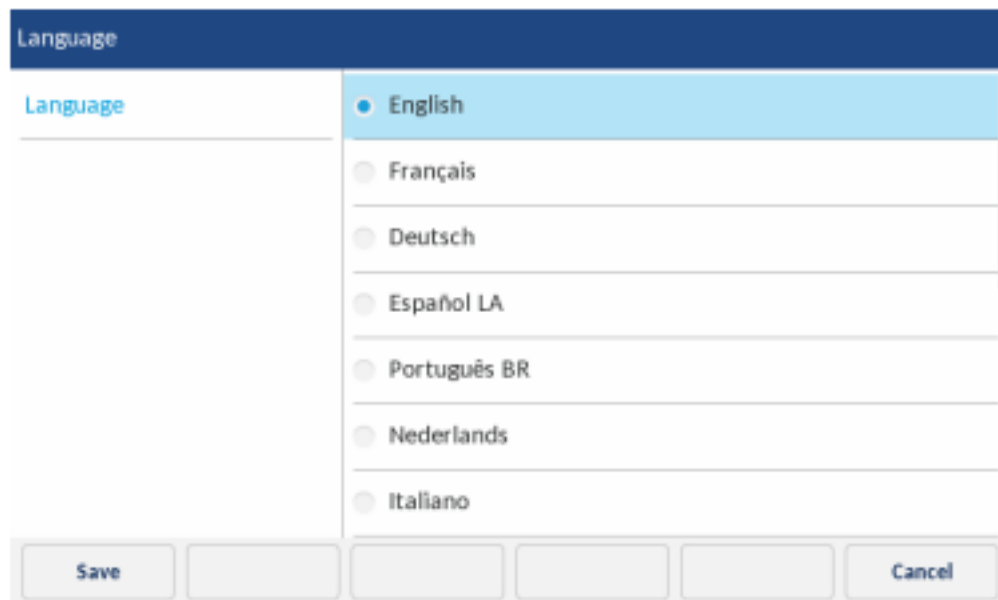

3. Swipe up and down to view the language available for selection.
4. Tap the applicable language.

5. Tap the **Save** softkey to save your changes.

Call Forward

Call Forward on the Mitel MiVoice 6940 IP phone allows incoming calls to be forwarded to another destination. You can enable your calls to be forwarded:

- When your phone is busy (individual settings for internal and external incoming calls).
- When you're not answering the phone (individual settings for internal and incoming calls).
- All the time.

You can enable different call forward modes independently. For example, you can set different phone numbers for Always, Busy Internal, Busy External, No Answer Internal, and No Answer External, and then turn them on/off individually.

NOTE:

1. A **Call Forward Always** programmable key can be created that allows you quickly enable Always mode without having to enter the **Call Forward** settings menu. For more information on the **Call Forward Always** programmable key, see [“Call Forward Always”](#).
2. If voicemail is enabled, call forwarding numbers may already be defined by your System Administrator.

To configure call forward settings:

1. Press the  (**Settings**) key on the phone to enter the **Settings** menu.
2. Tap the **Call Forward** icon.

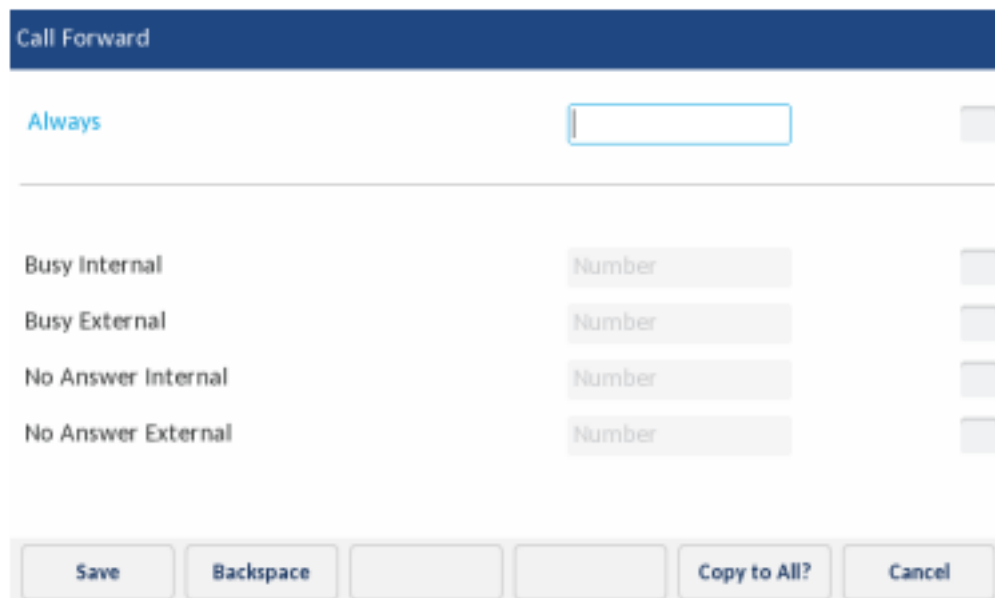

Mode	Input Field	Toggle
Always	[Empty]	<input checked="" type="checkbox"/>
Busy Internal	Number	<input type="checkbox"/>
Busy External	Number	<input type="checkbox"/>
No Answer Internal	Number	<input type="checkbox"/>
No Answer External	Number	<input type="checkbox"/>

Buttons: Save, Backspace, [Blank], Save, Copy to All?, Cancel

3. Tap the applicable **Number** input fields and enter forwarding numbers using the dialpad keys for any of the following states:

– **Always:**

Immediately forwards all incoming calls to the specified number.

– **Busy Internal:**

Immediately forwards internal phone calls if your line is busy.

– **Busy External:**

Immediately forwards external phone calls if your line is busy.

– **No Answer Internal:**

Forwards internal phone calls after several rings if you don't answer.

– **No Answer External:**

Forwards external phone calls after several rings if you don't answer.

NOTE: Tapping the **Copy to All?** softkey copies the call forward number of the call forward mode in focus to every call forward mode. For example, if the cursor is on the **Busy Internal** field and the field has a phone number entered, tapping the **Copy to All?** softkey assigns the same phone number to all the other modes as well.

4. Tap the checkbox beside the respective call forward mode you want to use to enable the call forward mode.
5. Tap the **Save** softkey to save your changes.

NOTE:

- a. When **Call Forward Always** is enabled, it takes precedence over all other types of call forwarding.
- b. If **Call Forward Always** is enabled, then the **Call Forward Always** icon is displayed on the Screen Saver.
- c. If both **Call Forward Always** and **DND** are enabled, then the **DND** icon is displayed on the Screen Saver.

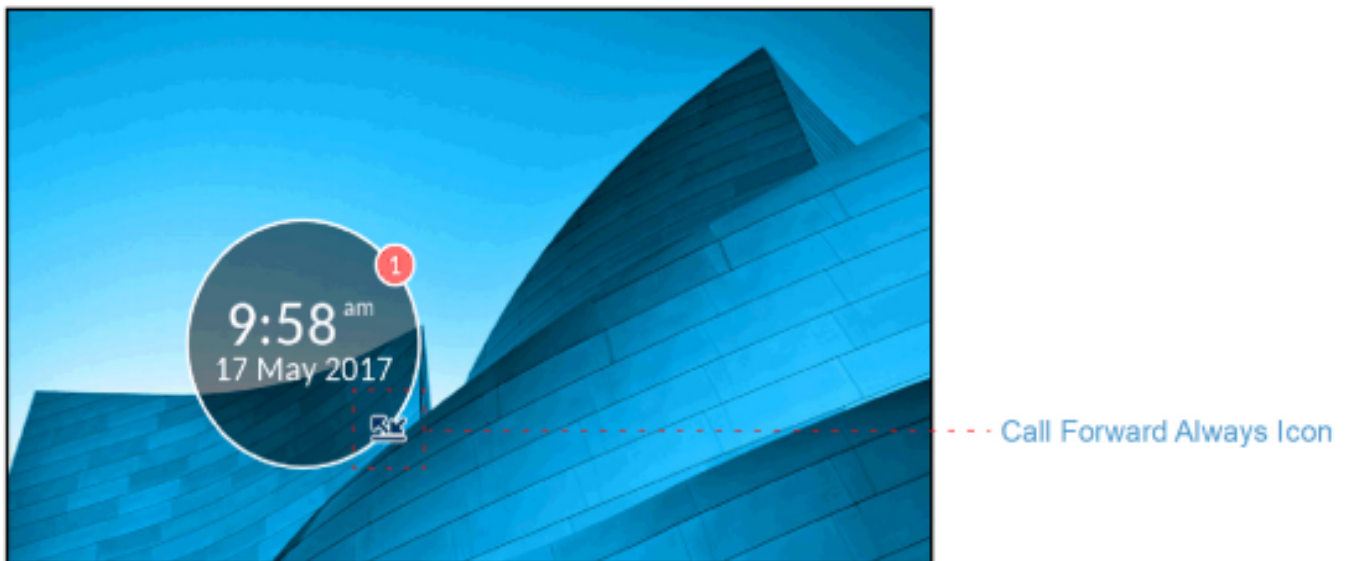

Bluetooth

The Mitel MiVoice 6940 IP phone supports MobileLink, a feature that provides seamless mobile integration using Bluetooth wireless technology.

NOTE: For more information on how to use the MobileLink features, see [“MobileLink”](#).

The phone also supports the use of Bluetooth devices such as, the Mitel Cordless Bluetooth Handset, the Mitel S720 Bluetooth Speakerphone, or a Bluetooth headset as an alternate audio device. Using the **Bluetooth** settings menu, you can enable and disable Bluetooth functionality on your phone as required. You can also pair, connect, and unpair a Bluetooth device as applicable.

NOTE:

1. The specific operation of third-party Bluetooth devices can vary somewhat by manufacturer and model. Ensure your Bluetooth device has been upgraded to its latest firmware revision. Refer to the documentation accompanying the Bluetooth device for details on operation, alerting tones, LEDs, and charging. Note that all Bluetooth devices will drop any call in progress if the maximum range is exceeded.
2. Only one Bluetooth device of each profile (i.e. handset, headset, speakerphone, and mobile phone) can be connected at one time. Connecting to a new device of the same profile will automatically result in the disconnection of the previous device of the same profile. If there is no connection to any device (within the same profile) the phone will actively look for the most recently connected device and will attempt to automatically reconnect. Manually disconnecting the device using the device’s native UI will not prevent an automatic reconnection. You must either disconnect using the **Bluetooth** menu on the Mitel MiVoice 6940 IP phone, “forget” the device, or the device must be out of range to circumvent the auto reconnect process.
3. Attempting to pair and connect using your Bluetooth device’s respective menus may cause connectivity issues. Follow the procedures listed in the sections below to ensure the connectivity of your Bluetooth device.
4. When using a multi-point Bluetooth headset with your Mitel MiVoice 6940 IP phone, do not pair your multi-point Bluetooth headset to multiple devices (For example, to your Mitel MiVoice 6940 IP phone and your mobile phone) as audio and connectivity issues may occur.
5. Some Bluetooth headsets have a proximity sensor feature that automatically changes the audio path depending on whether the headset is put on or taken off. It is strongly recommended to disable this feature when using the respective headset with the Mitel MiVoice 6940 IP phone as it may cause audio issues. Refer to the documentation accompanying the Bluetooth device for information on how to disable this feature.
6. Bluetooth headsets connected to the Mitel MiVoice 6940 IP phone are limited in functionality to answering, ending, and muting calls. Additional headset features (such as rejecting calls) are not supported and will cause unexpected behavior (e.g. invoking the reject call function will answer instead of reject).

Enabling Bluetooth functionality

To enable Bluetooth functionality:

1. Press the  (**Settings**) key on the phone to enter the **Settings** menu.
2. Tap the **Bluetooth** icon.



Swipe the toggle switch to the right to enable Bluetooth



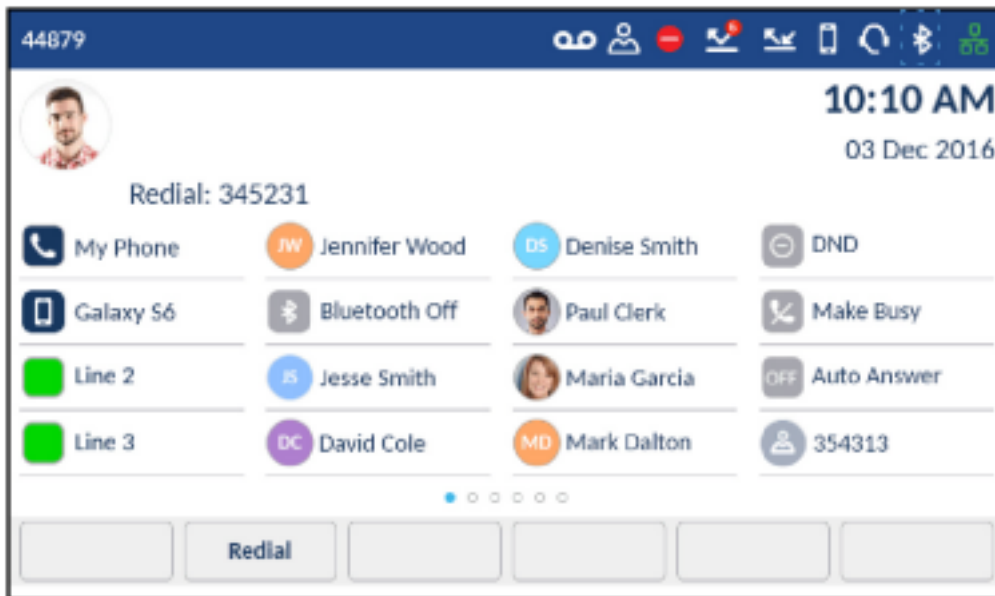

3. Swipe the Bluetooth toggle switch  to the right to enable Bluetooth functionality.

When Bluetooth functionality is enabled, a Bluetooth enabled icon  appears in the status bar on the **Home** screen.



Pairing a Bluetooth device

1. Press the  (**Settings**) key on the phone to enter the **Settings** menu.
2. Tap the **Bluetooth** icon.

3. Ensure Bluetooth functionality is enabled. If it is not enabled, swipe the Bluetooth toggle switch  to the right to enable Bluetooth functionality.
4. If required, tap **Available Devices** to view the list of discoverable Bluetooth devices.

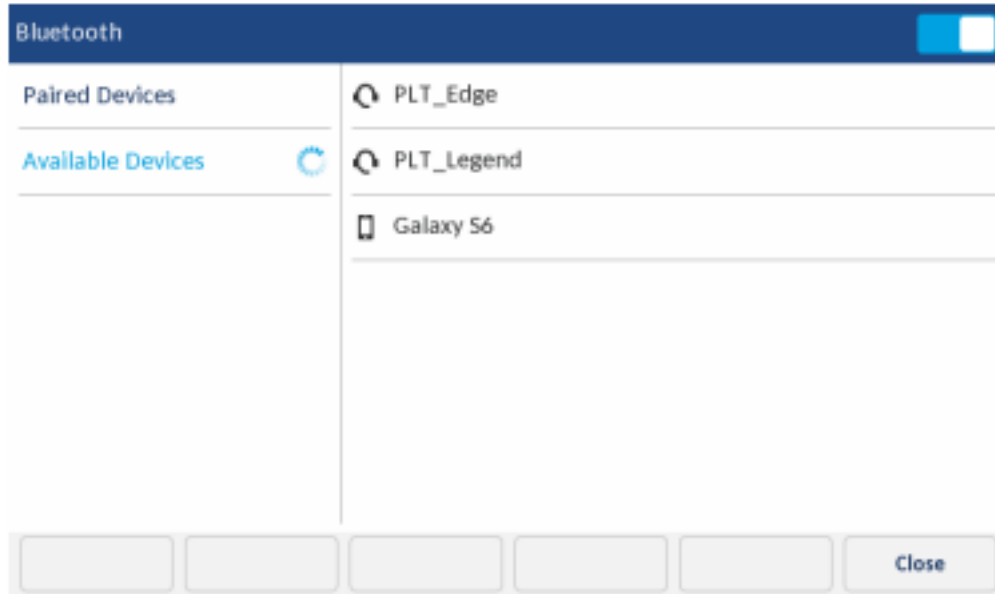

NOTE: The Mitel MiVoice 6940 IP phone scans for supported Bluetooth devices when viewing the list of available devices. Refer to the respective Bluetooth device documentation for discovery and pairing procedures that must be performed on your Bluetooth device.

5. Tap the Bluetooth device you want to pair to start the pairing process. The phone attempts to pair the Bluetooth device and if successful, automatically attempts to connect to the Bluetooth device.

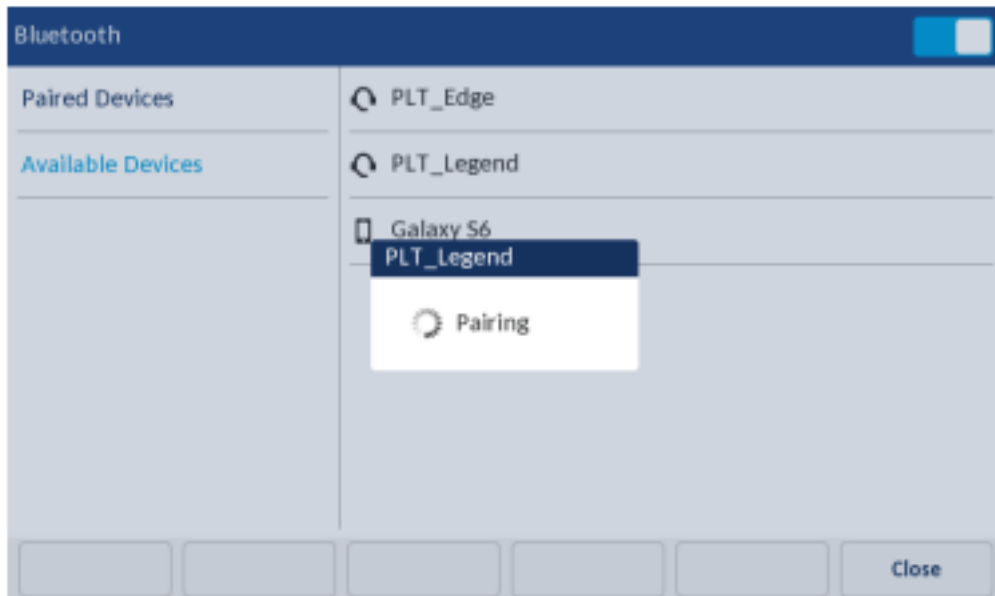

NOTE:

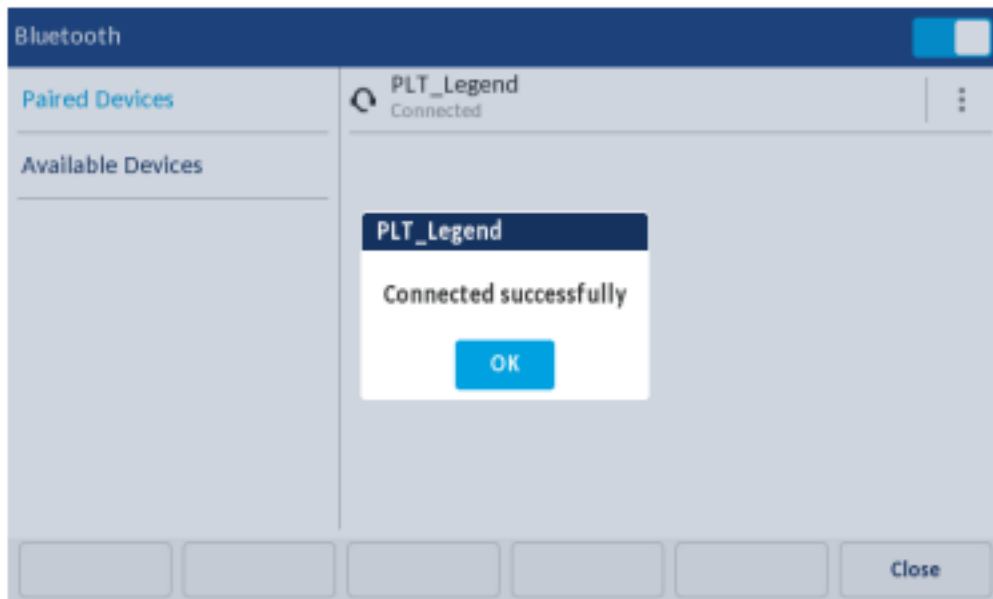

- a. The Mitel Bluetooth Cordless Handset included with the Mitel MiVoice 6940 IP phone comes automatically paired with the phone. If you need to pair the Mitel Bluetooth Cordless Handset again, power on the handset by placing the handset on the IP phone's cradle and follow the pairing procedures outline above. The handset's device name will appear in the available devices list as "Cordless Handset" followed by the last six digits of the handset's MAC address. For more information on the cordless Bluetooth handset, see ["Mitel Cordless Bluetooth Handset"](#).
- b. When attempting to pair the Mitel S720 Bluetooth Speakerphone with the Mitel MiVoice 6940 IP phone, the device name will appear in the available devices list as "S720 Bluetooth Speakerphone". For more information on the Mitel S720 Bluetooth Speakerphone, see ["Mitel S720 Bluetooth Speakerphone"](#).
- c. For mobile phones and some other Bluetooth devices, a Bluetooth pairing request displays on both the Mitel MiVoice 6940 IP Phone and the respective mobile phone or Bluetooth device. Ensure the pairing code matches on both devices and tap **Yes** on the Mitel MiVoice 6940 IP Phone and acknowledge the pairing request on your mobile phone or Bluetooth device.
- d. If pairing or connecting fails, a failed error message displays on screen. Tap **Retry** to attempt to pair or connect again, or **Cancel** to cancel the attempt.
- e. If pairing and connecting a mobile phone, depending on the connection state of the mobile phone, you may need to retry multiple times before the mobile phone pairs and connects successfully. Additionally, your Mitel MiVoice 6940 must be connected to the MiVoice Business phone system to pair and connect your mobile phone.



6. Tap **OK** to acknowledge the successful connection.

The MWI indicator flashes blue when successfully connected. The connected Bluetooth device is added to the list of **Paired Devices** and is ready to use.

When a Bluetooth headset is successfully connected, a Bluetooth headset connected icon  appears in the status bar on the **Home** screen. When a mobile phone is successfully connected, a Mobile

connected icon  appears in the status bar on the **Home** screen. When the Mitel S720 Bluetooth Speakerphone is successfully connected, a speakerphone connected icon  appears in the status bar on the **Home** screen.

When a paired Bluetooth Handset loses connectivity with the 6940 IP Phone, a warning message displays on the Home screen and an  icon appears in the status bar. Tap **OK** to clear the message.

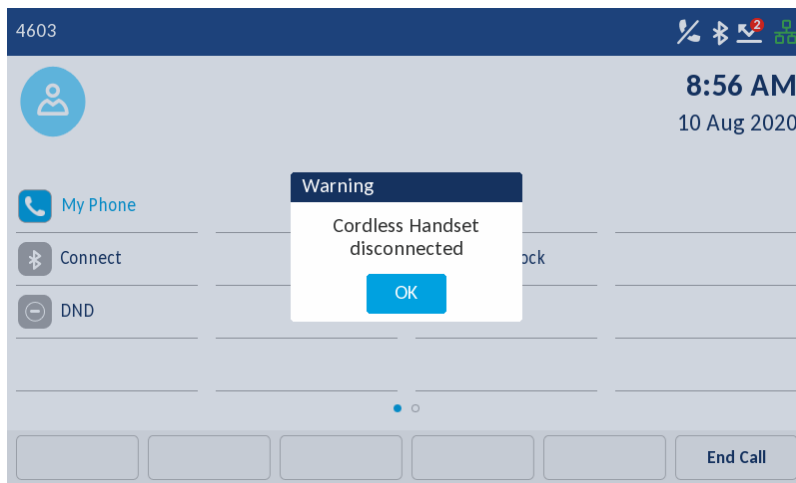

Additionally, an  icon appears on the screen saver bubble when the phone is in screen saver mode.



When the Bluetooth Handset is successfully re-connected, all notifications for connectivity loss disappear from the phone.

Forgetting a Bluetooth device

To forget a Bluetooth device:

1. Press the  (**Settings**) key on the phone to enter the **Settings** menu.
2. Tap the **Bluetooth** icon.

3. Ensure Bluetooth functionality is enabled. If it is not enabled, swipe the Bluetooth toggle switch  to the right to enable Bluetooth functionality.

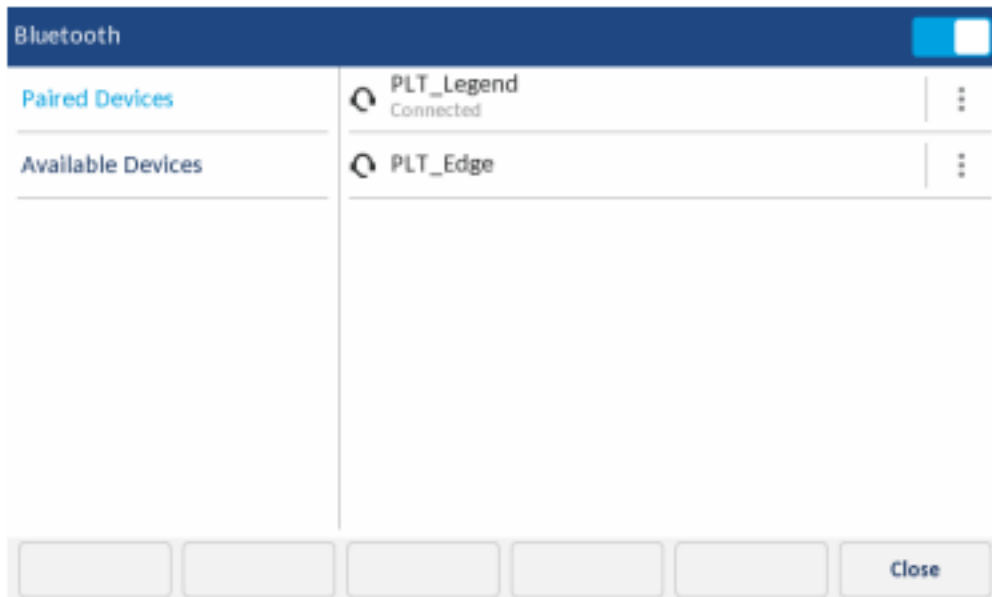

4. Tap the options icon beside the Bluetooth device you want to forget and tap the **Forget** softkey.

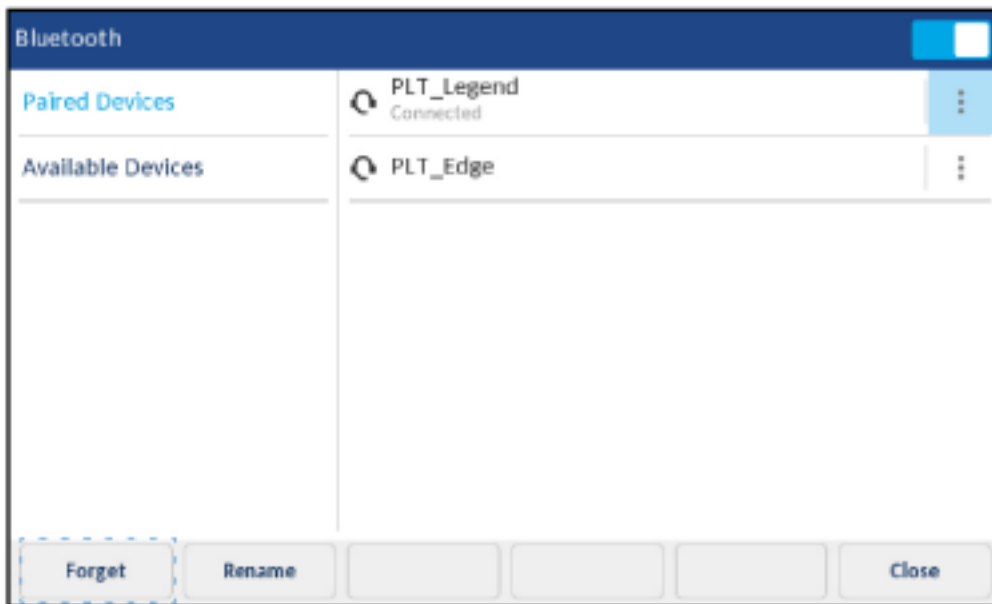

A confirmation message displays on screen.

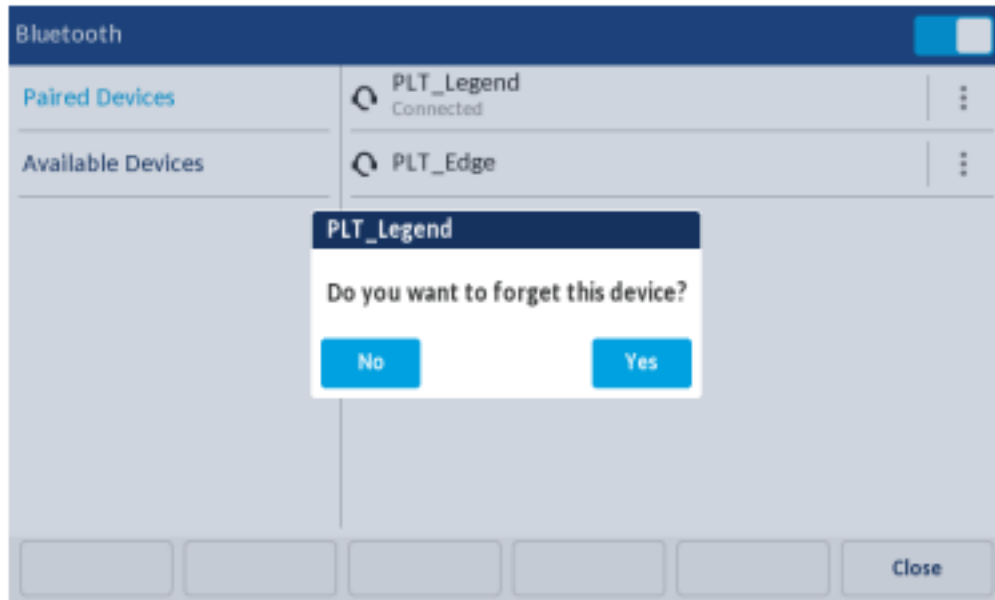



5. Tap **Yes** to forget the Bluetooth device.

The Bluetooth device is removed from the list of **Paired Devices**.

Disconnecting a connected Bluetooth device

To disconnect a connected Bluetooth device:

1. Press the  (**Settings**) key on the phone to enter the **Settings** menu.
2. Tap the **Bluetooth** icon.
3. Ensure Bluetooth functionality is enabled. If it is not enabled, swipe the Bluetooth toggle switch  to the right to enable Bluetooth functionality.

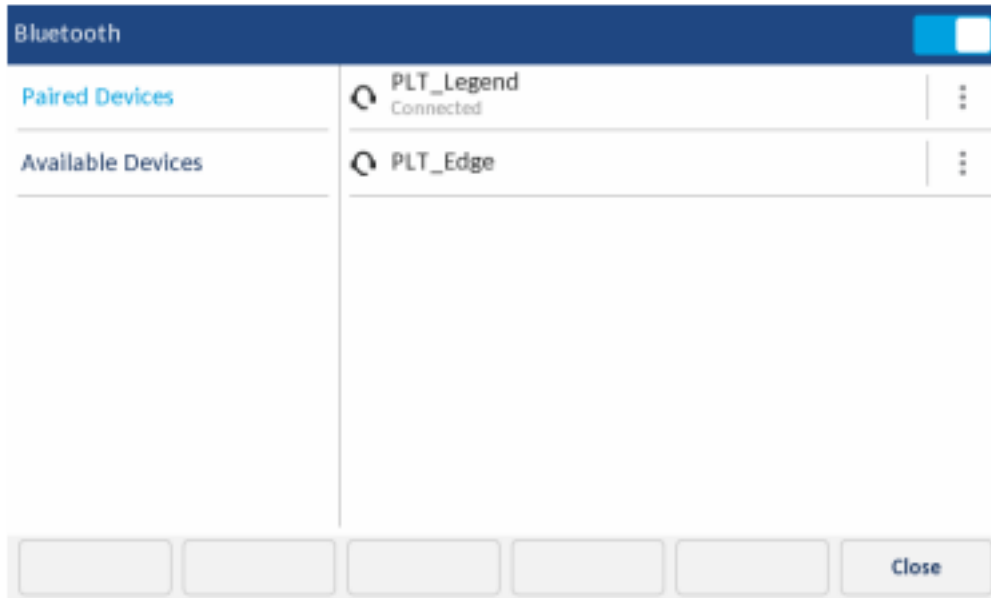

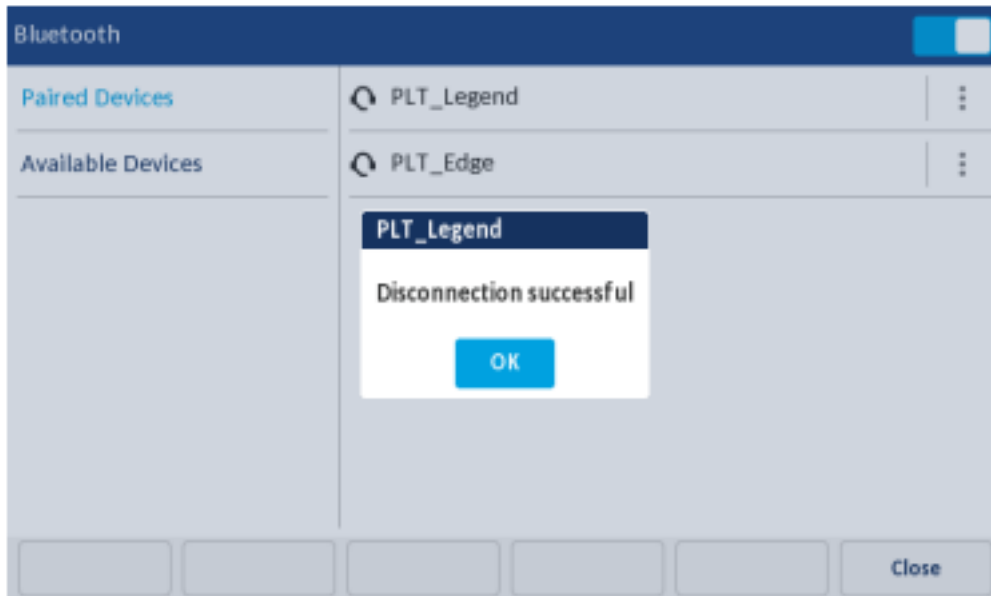

4. Tap the connected Bluetooth device you want to disconnect.
The Bluetooth device is disconnected.



5. Tap the **OK** button to acknowledge the successful disconnection.s

Renaming a paired Bluetooth device

To rename a paired Bluetooth device:

1. Press the  (**Settings**) key on the phone to enter the **Settings** menu.
2. Tap the **Bluetooth** icon.
3. Ensure Bluetooth functionality is enabled. If it is not enabled, swipe the Bluetooth toggle switch  to the right to enable Bluetooth functionality.

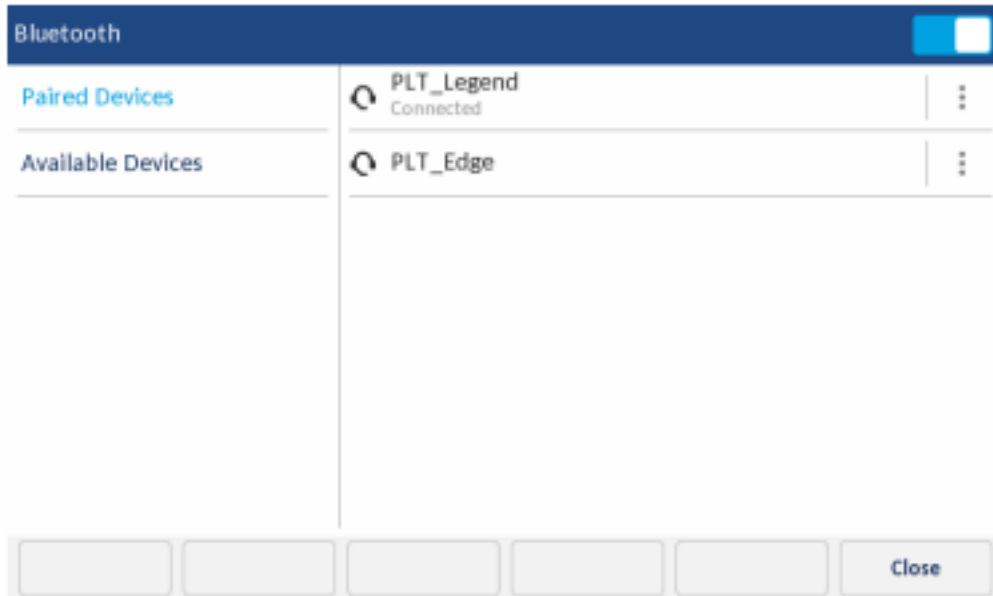

4. Tap the options icon beside the Bluetooth device you want to rename and tap the **Rename** softkey.

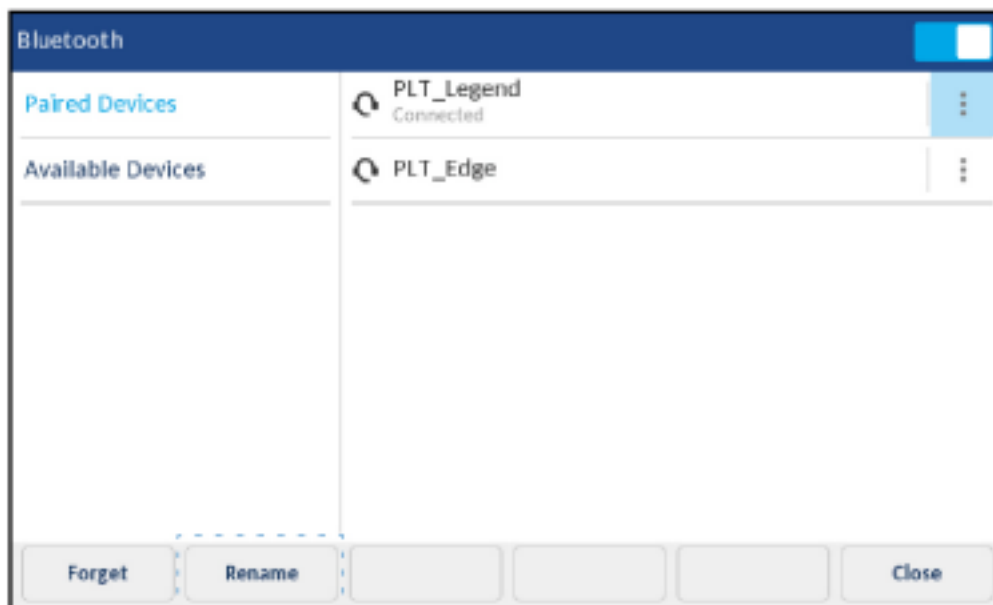

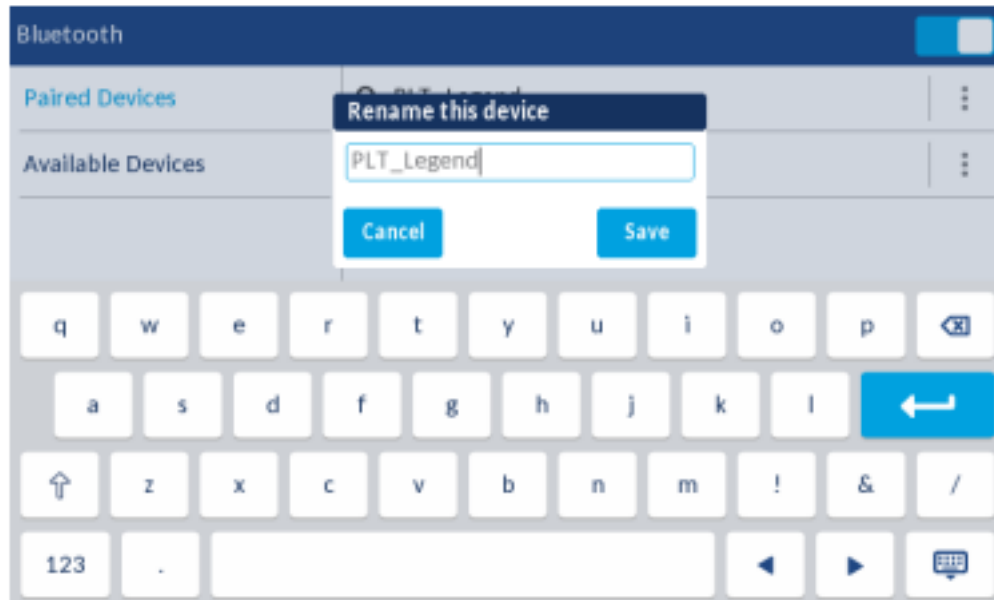

A pop up dialog appears allowing you edit the name of the Bluetooth device.



5. Edit the name of the device using the on-screen keyboard tap the **Save** softkey to save your changes.

Connecting to a different or disconnected Bluetooth device

To connect to a different or disconnected Bluetooth device:

1. Press the  (**Settings**) key on the phone to enter the **Settings** menu.
2. Tap the **Bluetooth** icon.
3. Ensure Bluetooth functionality is enabled. If it is not enabled, swipe the Bluetooth toggle switch  to the right to enable Bluetooth functionality.

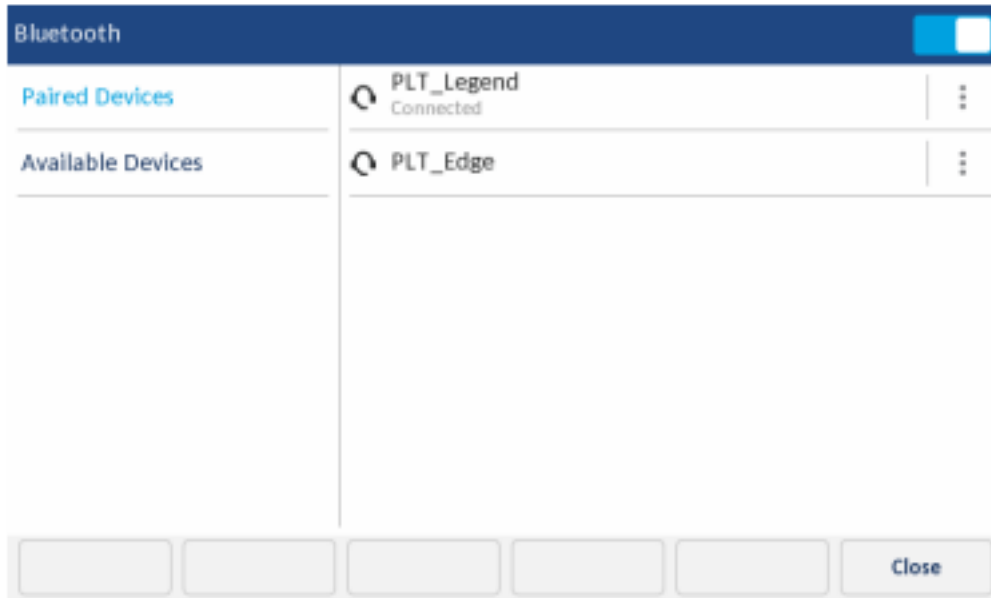

4. Tap the applicable Bluetooth device you want to connect to.
The phone attempts to connect to the device.

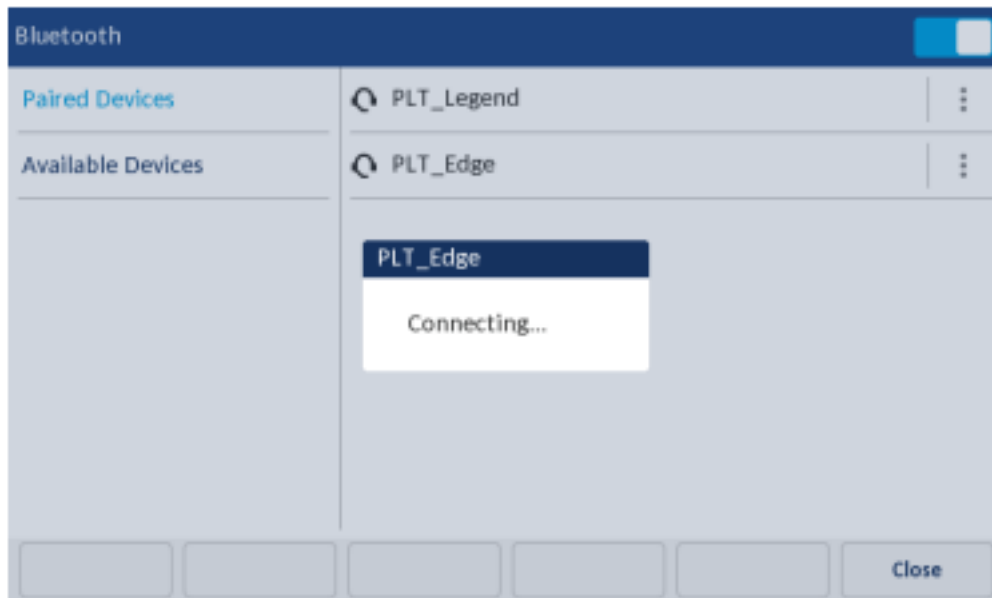

NOTE:

- a. If connecting fails, an error message displays on screen. Tap **Retry** to attempt to connect again, or **Cancel** to cancel the attempt.
- b. If connecting a mobile phone, depending on the connection state of the mobile phone, you may need to retry multiple times before the mobile phone connects successfully. Additionally, your Mitel MiVoice 6940 must be connected to the MiVoice Business phone system to connect your mobile phone.

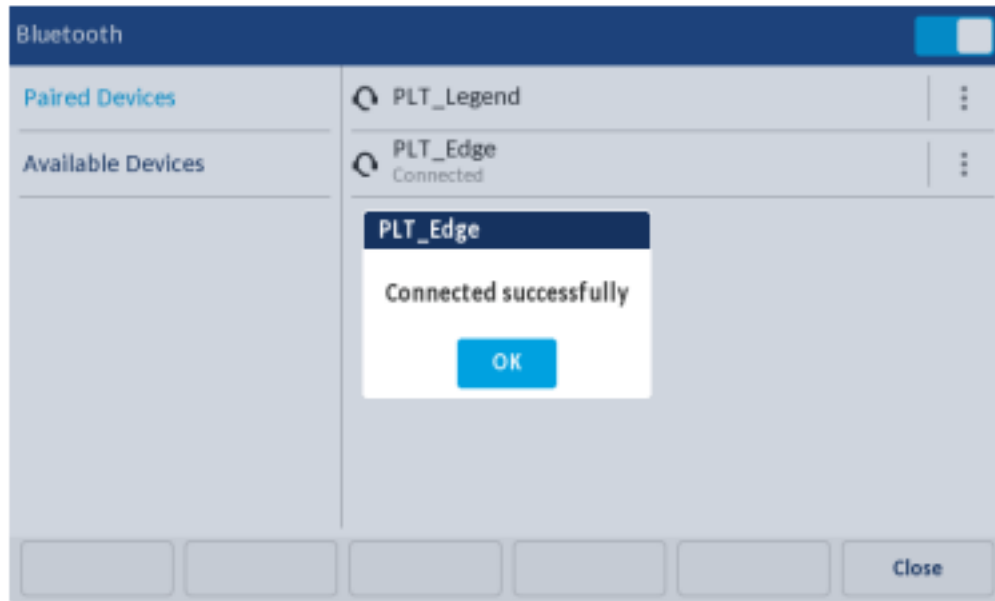

5. Tap the **OK** button to acknowledge the successful connection.

The MWI indicator flashes blue when successfully connected. The connected Bluetooth device is ready to use.

Audio

The **Audio** setting on the Mitel MiVoice 6940 IP phone allows you to personalize ring tones and select the initial audio path used when pressing the  (**Speaker/Headset**) key.

Ring Tones

There are a total of 20 (10 modern and 10 classic) distinct ring tones available for selection on the Mitel MiVoice 6940 IP phone. Two different ring tones can be configured for incoming calls from internal numbers and external numbers.

To configure ringtones for internal and external calls:

1. Press the  (**Settings**) key on the phone to enter the **Settings** menu.
2. Tap the **Audio** icon.
3. Tap the **Ring Tones** icon.

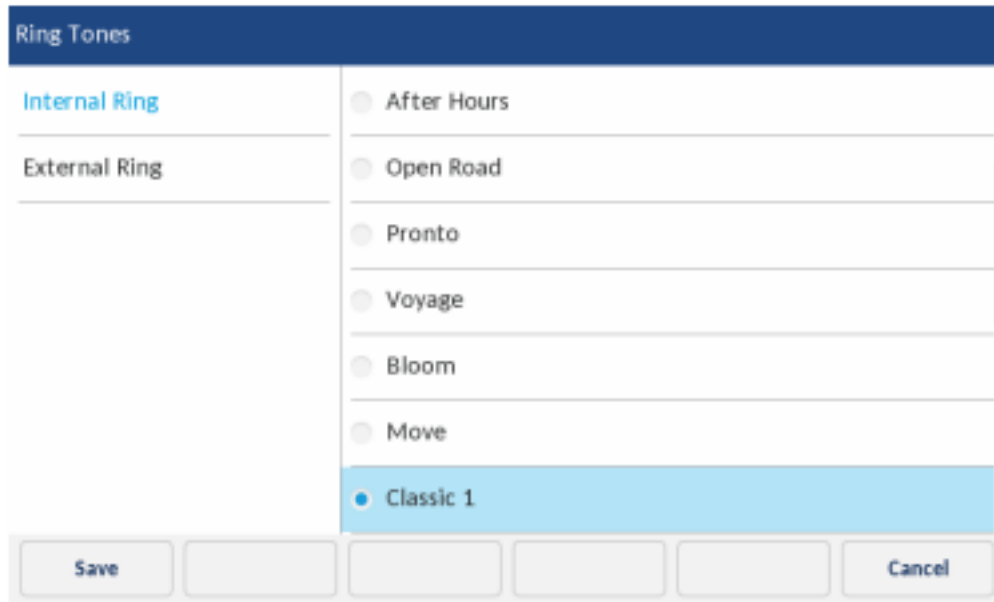





4. Swipe up and down to scroll through the list of internal ring tones and choose the applicable ring tone.
5. Tap **External Ring**.
6. Swipe up and down to scroll through the list of external ring tones and choose the applicable ring tone.
7. Press the **Save** softkey to save your changes.

Audio Path

The Mitel MiVoice 6940 IP phone allows you go "handsfree" when handling incoming and outgoing calls by supporting the use of a headset (Integrated DECT Headset, Bluetooth, USB, or through speakerphone mode). The **Audio Path** setting allows you to choose the initial audio path used when pressing

the  (**Speaker/Headset**) key. There are two audio path options that you can select:

Audio path	Description
Speaker	<p>The default setting. When using the handset, pressing the  (Speaker/Headset) key on the phone switches to the speakerphone.</p> <p>Pressing the  (Speaker/Headset) key again switches to the headset (if connected). When using the speakerphone or headset, lift the handset to switch to the handset.</p>

Headset	<p>When using the handset, pressing the  (Speaker/Headset) key on the phone switches to the headset. Pressing the  (Speaker/Headset) key again switches to the speakerphone. When using the headset or speakerphone, lift the handset to switch to the handset.</p>
---------	---

To configure the audio path:

1. Press the  (**Settings**) key to enter the **Settings** menu.
2. Tap the **Audio** icon.
3. Tap the **Audio Path** icon.

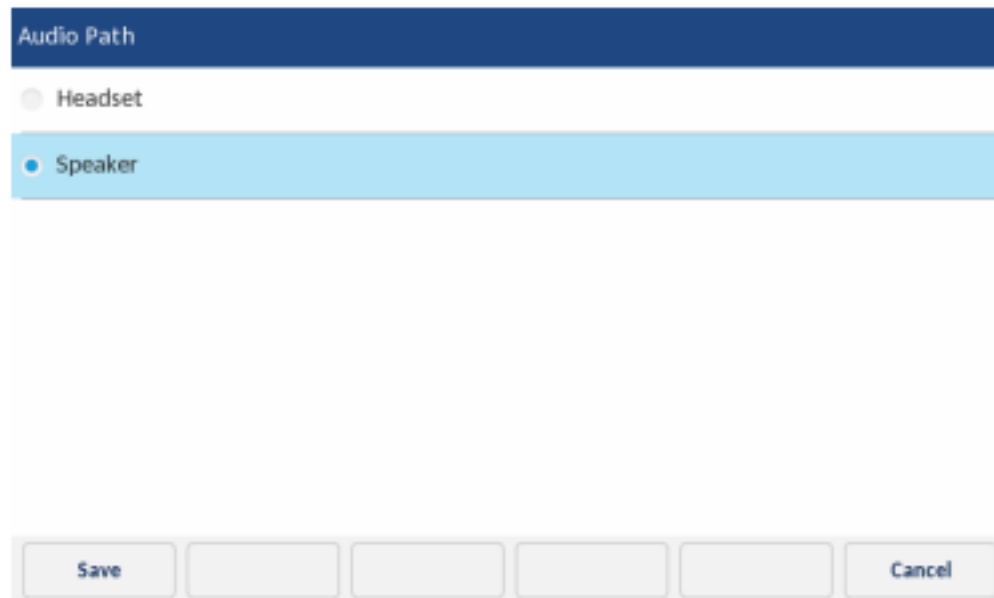

4. Tap the applicable audio path (**Speaker** or **Headset**).
5. Tap the **Save** softkey to save your changes.

Headset

The **Headset** setting allows you to enable USB Wireless mode when a USB Wireless headset is connected to the phone.

To enable/disable USB Wireless headset mode:

1. Press the  (**Settings**) key to enter the **Settings** menu.
2. Tap the **Audio** icon.
3. Tap the **Audio Path** icon.

4. Tap **Headset**.
5. Tap **USB Wireless**.

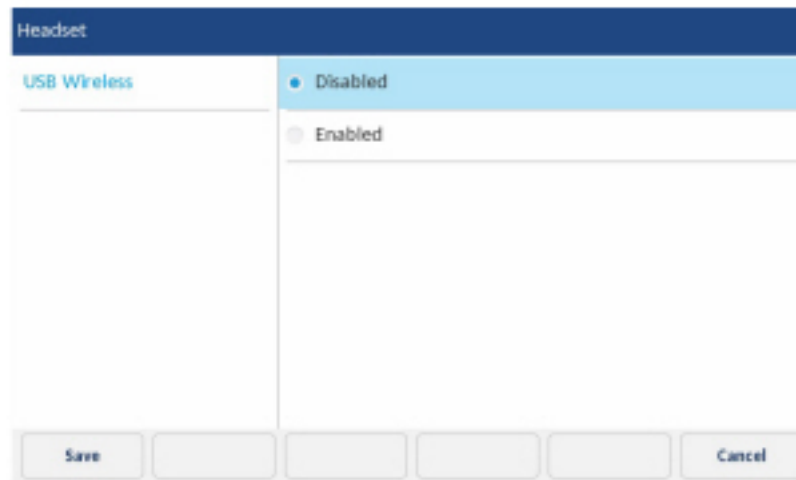

6. Tap enable/disable to choose the applicable setting.
7. Press the **Save** softkey to save your changes.

NOTE: Disable this setting if you are not using USB Wireless Headset.

Display

The **Display** setting allows you to set the following on your phone:

- **Brightness Settings:**
The **Brightness Level** setting on the Mitel MiVoice 6940 IP phone allows you to set the amount of light that illuminates the LCD display.
- **Screen Saver Settings:**
The **Screen Saver Timer** setting allows you to configure the amount of time (from 1 to 90 minutes) the phone must be idle before the screen saver starts. When the specified amount of time expires, a screen saver displaying the date and time and the number of missed calls (if applicable) is displayed on screen.



The **Dimmer Level** setting defines how brightly you want the screen to be illuminated when the screen saver is displayed.

NOTE: Availability of the above display settings is dependent on how your account is configured on the MiVoice Business call server.

To configure the display settings:

1. Press the  (**Settings**) key on the phone to enter the **Settings** menu.
2. Tap the **Display** icon.

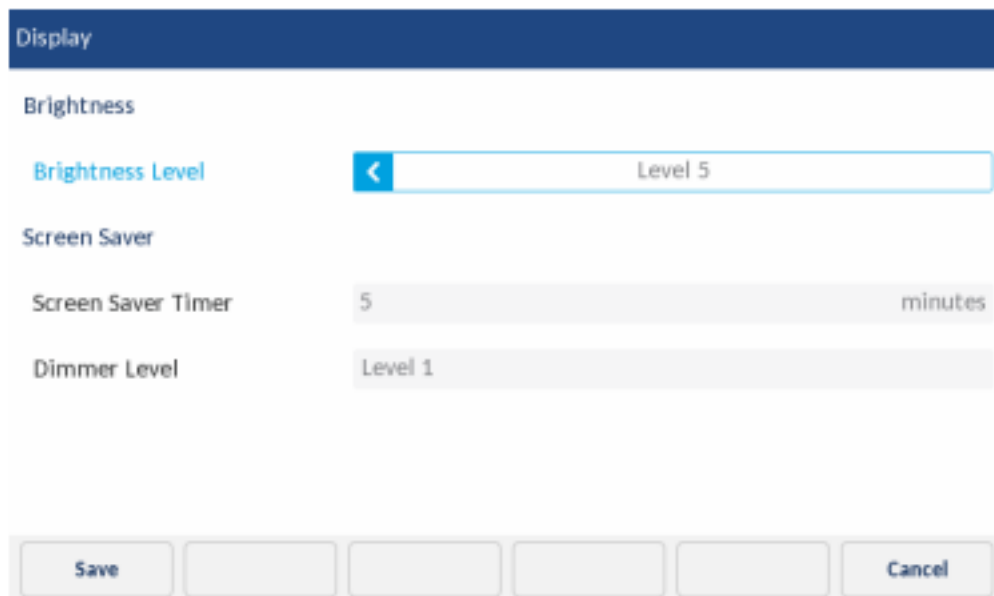

3. Tap the left and right arrow buttons in the **Brightness Level** field to increase or decrease the intensity of brightness on the LCD (valid values are from Levels 1 (darkest) to 5 (brightest)).
4. Tap the **Screen Saver Timer** field.
5. Enter a value, in minutes, using the dialpad keys. You can set the timer from 1 to 90 minutes. The default is 5 minutes.
6. Tap the **Dimmer Level** field.
7. Tap the left and right arrow buttons in the **Brightness Level** field to increase or decrease the intensity of brightness on the LCD when the screen saver is displayed (valid values are from Levels 0 (LCD off) to 5 (brightest)).
8. Press the **Save** softkey to save your changes.

Voice Services

The Mitel MiVoice 6940 IP phone can be configured to provide remote workers access to the same rich communications capabilities as in-office workers using **Voice Services**.

During the initial boot-up of the IP phone, at 95% a **Voice Services** screen auto prompts the user to select an appropriate service.

The user can select from one of the following service options -

- **MiCloud Connect service** for MiCloud Connect SIP users
- **MiVoice Border Gateway service** for MiNet Teleworker users

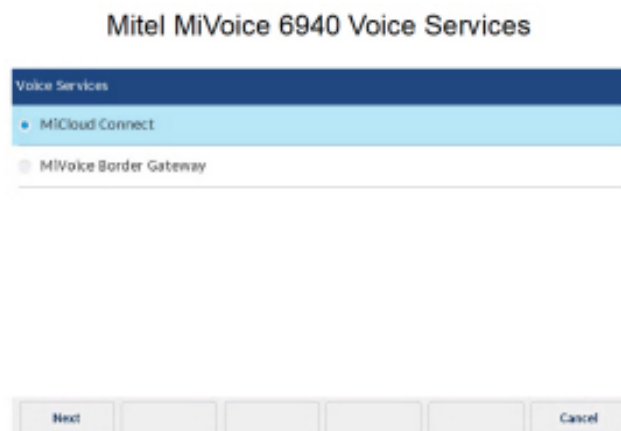

- For MiCloud Connect, enter **User DID** and **Password**.

Mitel MiVoice 6940 Voice Services

MiCloud Connect

User DID	
Password	
Domain	sky.shoretel.com

Register
Backspace

OK
Cancel

- For MiVoice Border Gateway, enter the IP address of the server providing the teleworker configuration details in the **IP Address** field using the dialpad keys.

Mitel MiVoice 6940 Voice Services

MiVoice Border Gateway

IP Address	
------------	--

Save
Backspace
Dot **

Cancel

NOTE: The **Backspace** softkey can be used to delete the last digit/character entered and the dot (".") softkey can be used to enter a dot where applicable.

To view/edit the Voice Services settings on the Mitel MiVoice 6940 IP phone:

1. Press the  (**Settings**) key on the phone to enter the **Settings** menu.
2. Tap the **Voice Services** icon.
3. Tap on one of the following options:
 - MiCloud Connect
 - MiVoice Border Gateway
4. Make the required changes.
5. Tap the **Save/Register** softkey to save your changes.

Manual Upgrade

By factory default, the 6900 Series IP Phones have the MiNet firmware pre-installed. You can upgrade the default firmware to the latest release of MiNet. You can also enable interoperability with Mitel's SIP-based solutions by upgrading the 6900 Series IP Phones to the SIP firmware.

To perform the manual upgrade, you must configure a connection to the server where the firmware is stored. The 6900 Series IP Phones support the following protocols to download a new firmware:

- TFTP
- FTP
- HTTP
- HTTPS

NOTE: The server must be configured to support downloading firmware using any of these protocols.

To configure connection settings for manual upgrade:

1. Press the  key to enter the Settings menu.
2. Navigate to **Voice Services > Manual Upgrade** and Tap **Next** softkey.

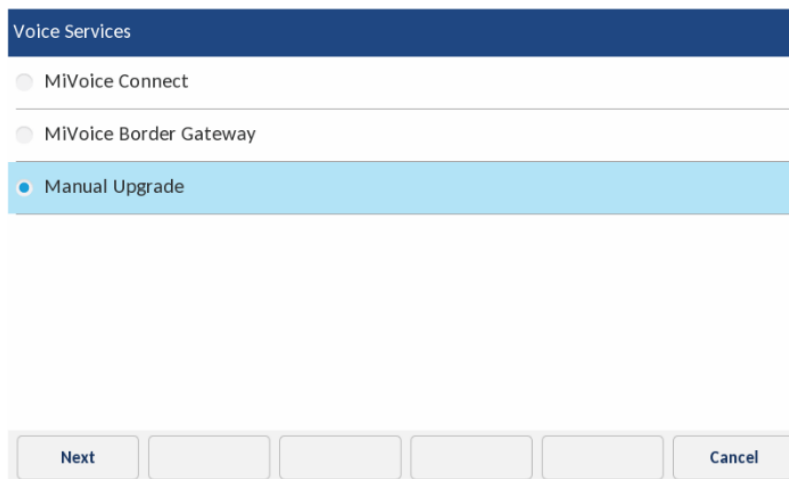

NOTE: The service options under Voice Services also displays MiCloud Connect, if the IP phone has an alternate SIP load available.

3. In the **Download Protocol** field, select the protocol for downloading firmware from the server.

The screenshot shows a 'Manual Upgrade' screen with a dark blue header. Below the header, there are four input fields: 'Download Protocol' (with a dropdown menu showing 'TFTP'), 'TFTP Server', 'TFTP Port', and 'TFTP Path'. At the bottom of the screen, there is a row of buttons, including a 'Save' button and a 'Cancel' button.

4. In the **Server** field, enter the domain name or the IP address of the server.
5. In the **Port** field, enter the server port that is used for downloading firmware.
6. In the **Path** field, enter the name of the folder(s) where the firmware you want to install is stored.
7. The above screenshot displays the fields for TFTP and similarly, you may select any of the protocols and update required fields.
8. Tap **Save**.

The IP phone automatically reboots.

After restart, the IP phone downloads the firmware from server and completes the upgrade.

NOTE:

- The IP Phone initially attempts to download the MiNet firmware. If unsuccessful, the phone next attempts to download the SIP firmware.
- On the failure scenario, Phone will display an **Upgrade main failed** status message followed by the address entered by the user.

Diagnostics

The **Diagnostics** menu allows you to perform the following diagnostic routines:

- Audio Diagnostics
- Ping
- TCP DUMP
- DHCP Trace

Audio Diagnostics

The **Audio Diagnostics** sub-menu allows you to collect up to 5 minutes of audio log files that can help to debug audio issues on the Mitel MiVoice 6940 IP phone.

To capture audio diagnostic logs on the Mitel MiVoice 6940 IP phone:

1. Press the  (**Settings**) key on the phone to enter the **Settings** menu.
2. Tap the **Diagnostics** icon.
3. Tap the **Audio Diagnostics** icon.

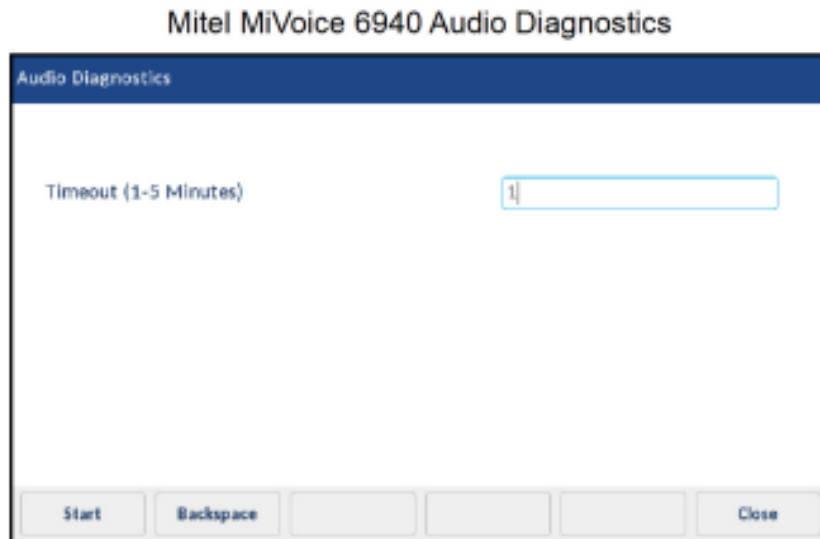

4. In the **Timeout** input field, enter the amount of time (in minutes from 1 to 5) you would like to run the audio diagnostic tool for using the dialpad keys.

The IP phone displays "Capturing..." and when the timeout elapses, "Collecting Logs..." is displayed. When all the logs have been collected, a "Complete..." message is displayed.

NOTE: Tap the **Stop** softkey at any time to stop capturing the audio diagnostic logs.

To save the audio diagnostic logs to your PC using the Mitel Web UI:

1. Open your web browser and enter the phone's IP address or host name into the address bar.
2. Enter your username and password and click **OK/Login**.

The status window displays for the IP phone you are accessing.

NOTE: The default username is "root" and the default password is "73738".

3. Click on **Diagnostics**.

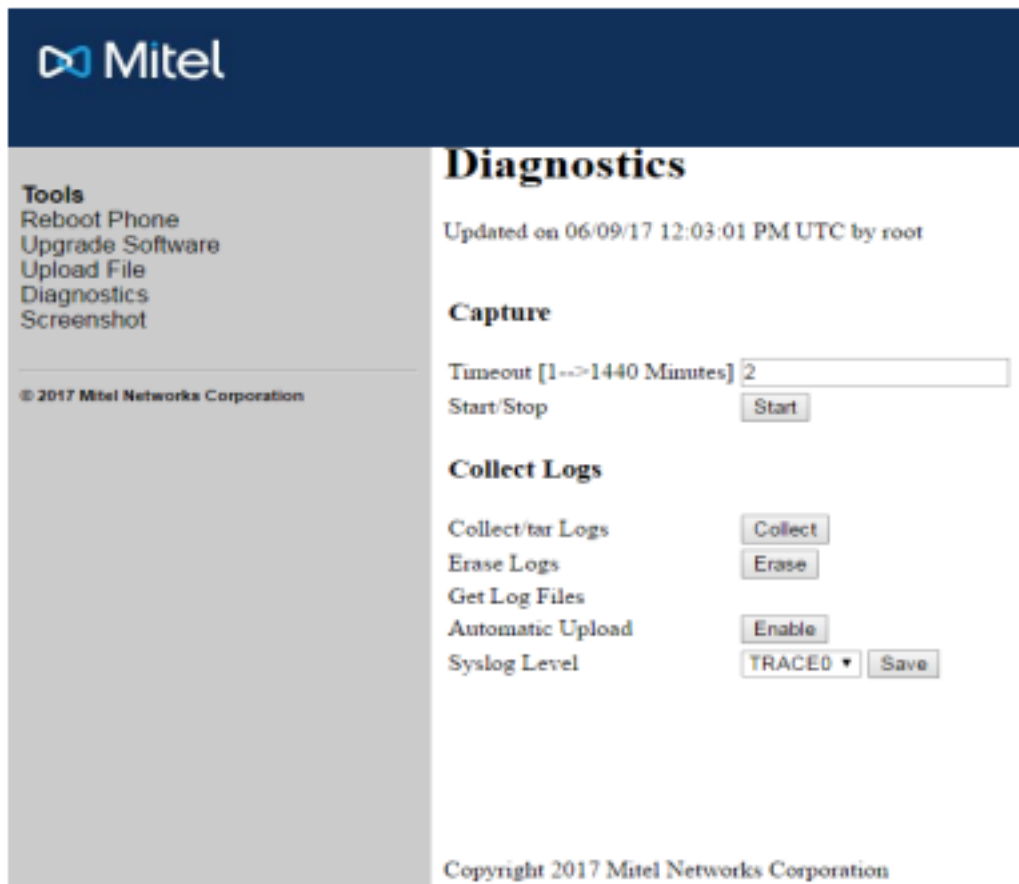

4. Click on the **Download Audio Log Files** link beside **Get Log Files**.
5. Save the file to the desired location on your computer.

NOTE: For more information on Mitel Web UI features, see the *Mitel MiVoice 6900 Series IP Phones Administrator Guide*.

Ping

The **Ping** sub-menu allows you to ping a host name or IP address directly from the Mitel MiVoice 6940 IP phone. This tool can be used to verify whether or not network connections between the Mitel MiVoice 6940 IP phone and other network endpoints are intact.

To use the ping tool on the Mitel MiVoice 6940 IP phone:

1. Press the  (**Settings**) key on the phone to enter the **Settings** menu.
2. Tap the **Diagnostics** icon.
3. Tap the **Ping** icon.



4. In the input field, enter the host name or IP address of the network endpoint you want to ping using the on-screen keyboard.
5. Tap the **Ping** softkey to begin.

The IP phone displays the number of packets sent, the number of packets received, and the Round-Trip Time (RTT) min/avg/max in milliseconds.

TCP DUMP

The **TCP DUMP** sub-menu allows you to capture TCP network packets for up to 1440 minutes that can in turn be used to help debug and troubleshoot various issues.

NOTE: During a TCP DUMP network packet capture, only the most recent 20 MB of the capture is retained.

To capture TCP network packets on the Mitel MiVoice 6940 IP phone:

1. Press the  (**Settings**) key on the phone to enter the **Settings** menu.
2. Tap the **Diagnostics** icon.
3. Tap the **TCP DUMP** icon.

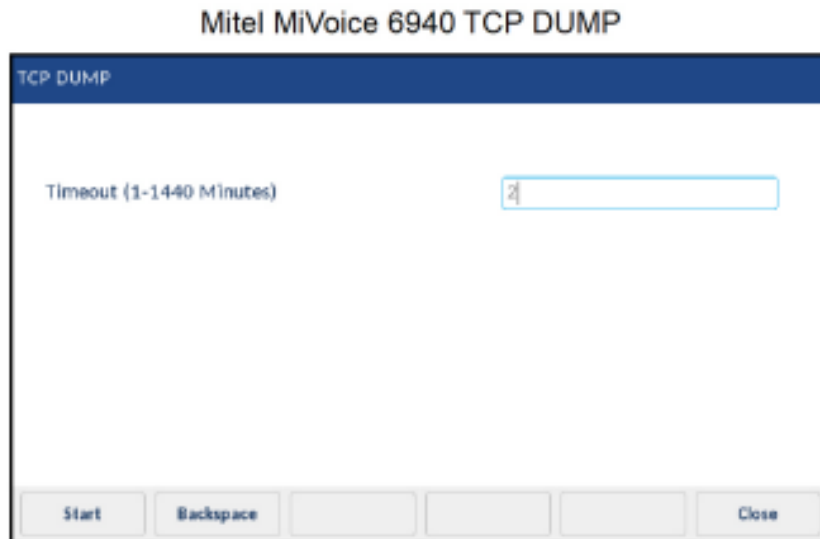

4. In the **Timeout** input field, enter the amount of time (in minutes from 1 to 1440) you would like to capture TCP network packet data using the dialpad keys.

The IP phone displays "Capturing..." and when the timeout elapses, "Complete..." is displayed.

NOTE: Tap the **Stop** softkey at any time to stop capturing the TCP DUMP logs.

To save the TCP network packet logs to your PC using the Mitel Web UI:

1. Open your web browser and enter the phone's IP address or host name into the address bar.
2. Enter your username and password and click **OK/Login**.

The status window displays for the IP phone you are accessing.

NOTE: The default username is "root" and the default password is "73738".

3. Click on **Diagnostics**.

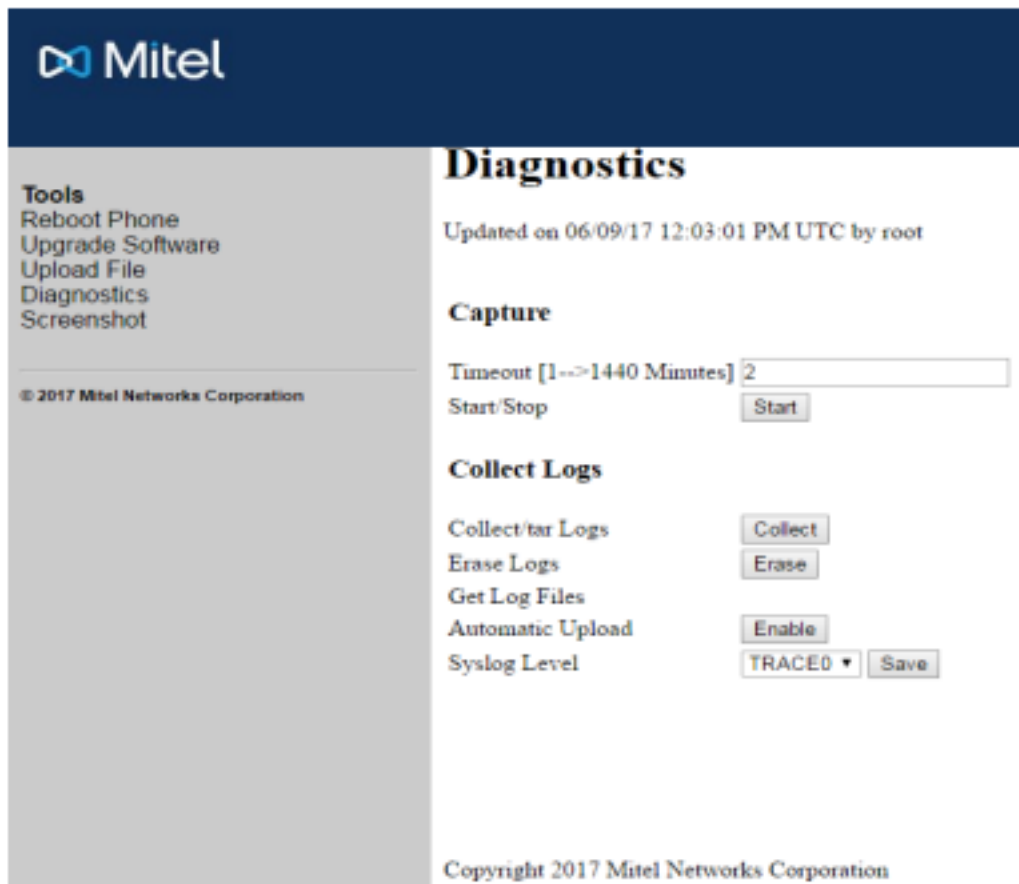

4. Click on the **Download Log Files** link beside **Get Log Files**.
5. Save the file to the desired location on your computer.

NOTE: For more information on Mitel Web UI features, see the *Mitel MiVoice 6900 Series IP Phones Administrator Guide*.

DHCP Trace

The **DHCP Trace** sub-menu allows you to perform a DHCP trace request. You can then review the parameters that the DHCP trace returns. After you have reviewed the trace information, the DHCP Lease is released.

To perform a DHCP trace on the on the Mitel MiVoice 6940 IP phone:

1. Press the  (**Settings**) key on the phone to enter the **Settings** menu.
2. Tap the **Diagnostics** icon.
3. Tap the **DHCP Trace** icon.

Mitel MiVoice 6940 DHCP Trace

DHCP Trace	
mac_addr:	06:00:0f:9f:96:68
ip addr:	10.30.100.109
netmask:	255.255.255.0
gateway:	10.30.100.1
dns:	10.72.2.26
icp:	
tftp:	0.0.0.0

The following parameters and associated values are displayed:

- **mac_addr:**
The MAC address of the IP phone.
- **ip addr:**
The IP address of the IP phone.
- **netmask:**
The IP address range local to the IP phone.
- **gateway:**
The IP address of the network’s gateway or default router IP address.
- **dns:**
The IP address of the primary DNS server.
- **icp:**
The IP address of the MiVB call server.
- **tftp:**
The IP address of the TFTP server.
- **http:**
The IP address of the HTTP server.
- **ipa:**
The IP address of the IPA server.
- **VLAN:**
The VLAN id of the IP phone.
- **I2p:**L2P priorities for default, voice, signaling, and other.
- **dscp:**
DSCP values for default, voice, signaling, and other.

Wi-Fi

The **Wi-Fi** option in the **Settings** menu of Mitel MiVoice 6900 Series IP phones allows you to connect the phone to a Wi-Fi network.

The following describes the three Wi-Fi connectivity states along with the corresponding icons displayed on the status bar:

1. **No network** - The WLAN adapter is not configured or the connected SSID is down.

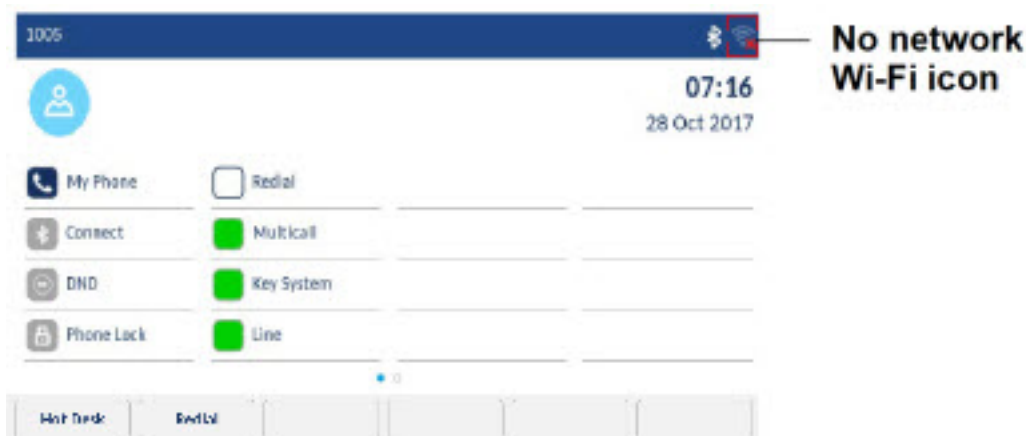

2. **Not Connected** - The phone is connected to the WLAN adapter but not connected to MiVoice Business or MiVoice Border Gateway.



3. **Connected** - The phone is connected to the WLAN adapter and MiVoice Business or MiVoice Border Gateway.



Connecting to a Wi-Fi network

To connect the phone to a Wi-Fi network, perform the following steps:

1. Press the  (**Settings**) key on the phone to enter the **Settings** menu and tap the **Wi-Fi** icon.

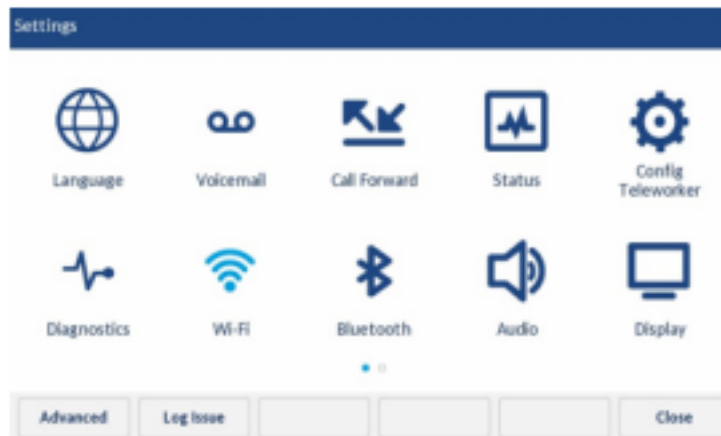

2. Ensure that a WLAN adapter is connected to the phone. The phone displays an error if it is not connected to a WLAN adapter.



To set up a WLAN adapter, see the *Mitel WLAN Adapter Administration Guide* or contact your system administrator.

3. If a WLAN adapter is connected to the phone, two sets of **Wi-Fi** menu items are displayed:
 - a. **Saved Network:** Displays the Wi-Fi network currently connected to the phone.
 - b. **Available Networks:** Scans and displays a list of available networks within the range of your phone.



4. Select an SSID (that is, the name of a Wi-Fi network, for example, **Mitel Secure**) from **Available Networks** to connect. If the SSID is secured, a password prompt appears.

NOTE: SSIDs with UTF-8 characters are not supported.

5. Enter the password for the network and select **Save**.

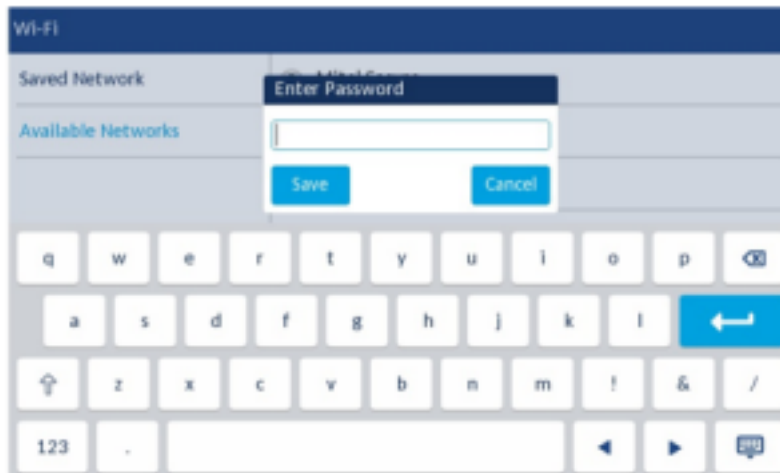

6. If you entered the correct password, the **Save Settings** window appears.
7. Select **Yes** to save your settings and to reboot the WLAN adapter and the phone. The phone is successfully connected to the network.

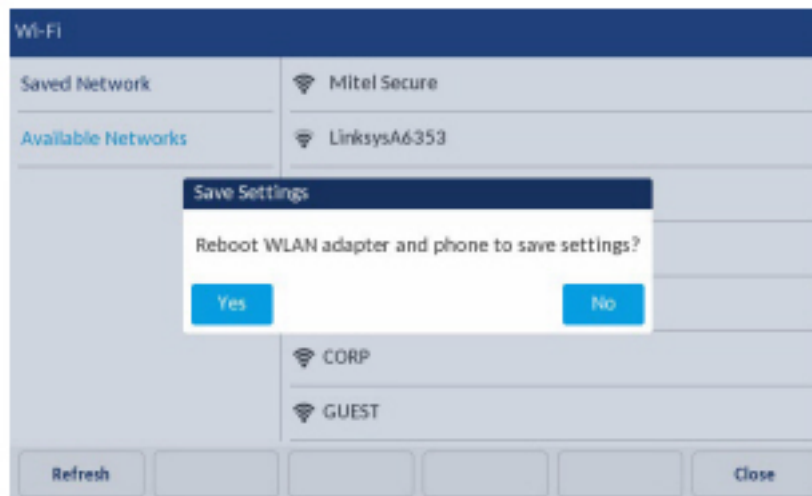

8. The connected SSID (Mitel Secure) is listed under **Saved Network**.

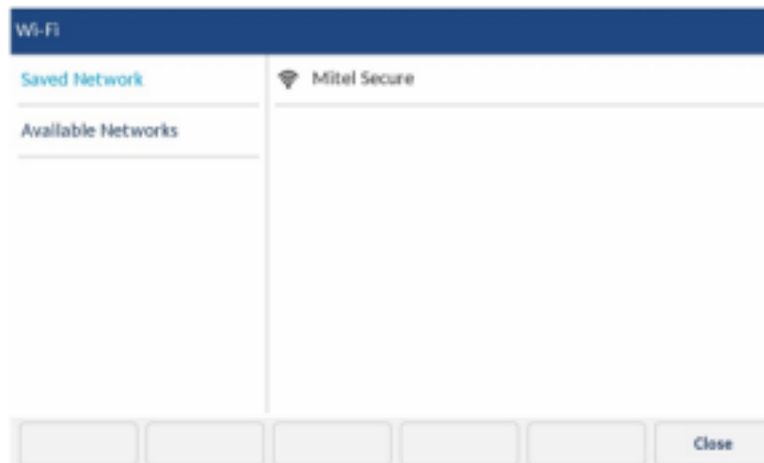

9. If the password you entered is incorrect, a **Connection failed** alert appears. To reenter the password, select **Retry**; to cancel the connection attempt, select **Cancel**.

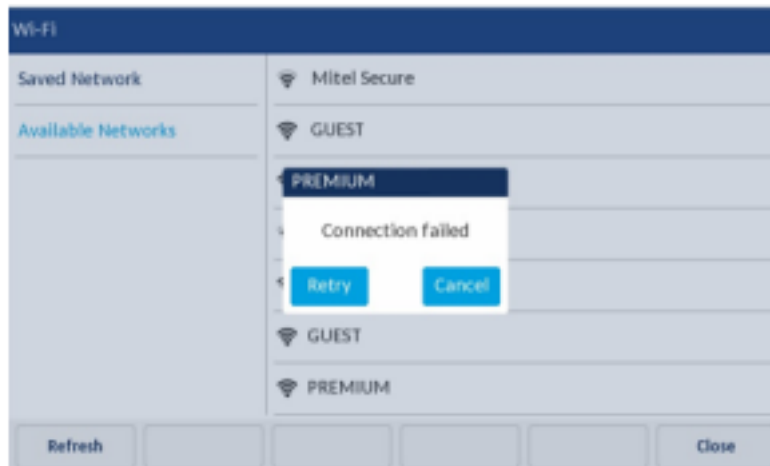

NOTE: If the password that you entered is incorrect, the phone normally displays the option to retry. In some cases, an incorrect password is accepted by the WLAN adapter but on reboot the Wi-Fi app auto pops up if phones fails on DHCP due to misconfiguration. You must enter the correct password again for the SSID.

10. Press **Refresh** to refresh the list of available networks. The phone searches for new networks within its range and updates the list of available networks.

Restart

The **Restart** setting allows you to restart your phone. You may need to restart your phone if you have been asked to do so by your System Administrator should you experience any unexpected behavior.

To restart your phone:

1. Press the  (**Settings**) key on the phone to enter the **Settings** menu.
2. Tap the **Restart** icon.

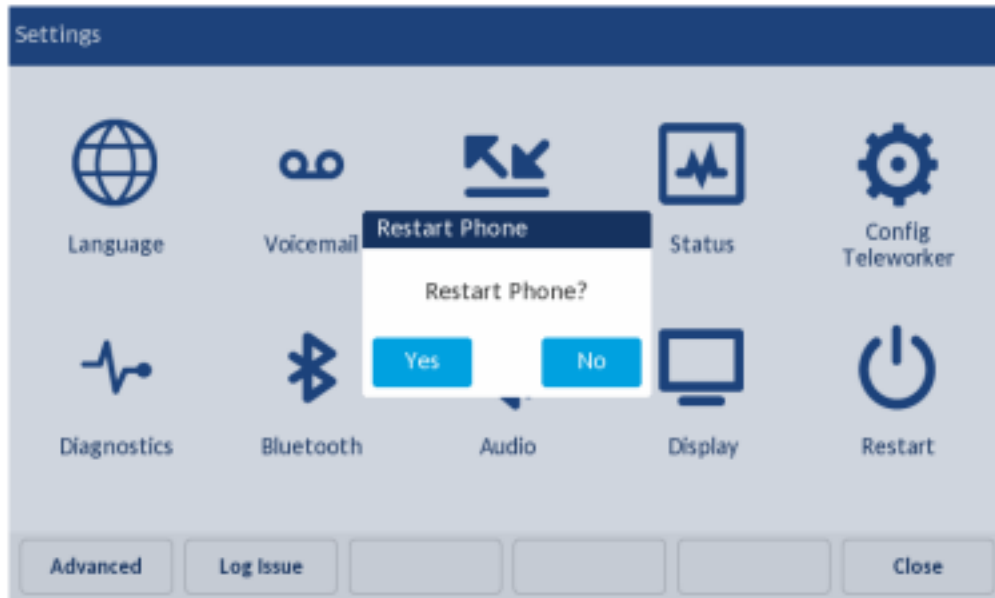

- When the prompt, **Restart Phone?** appears, tap **Yes** to restart the phone. If you do not wish to restart your phone, press **No** or the **Cancel** softkey.

NOTE: Your phone will be temporarily out of service during the restart process.

Configuring and using programmable keys

Your Mitel MiVoice 6940 IP phone has 96 (16 visible at one time) programmable, multi-function, self-labeling keys allowing you to program and use up to 96 functions.

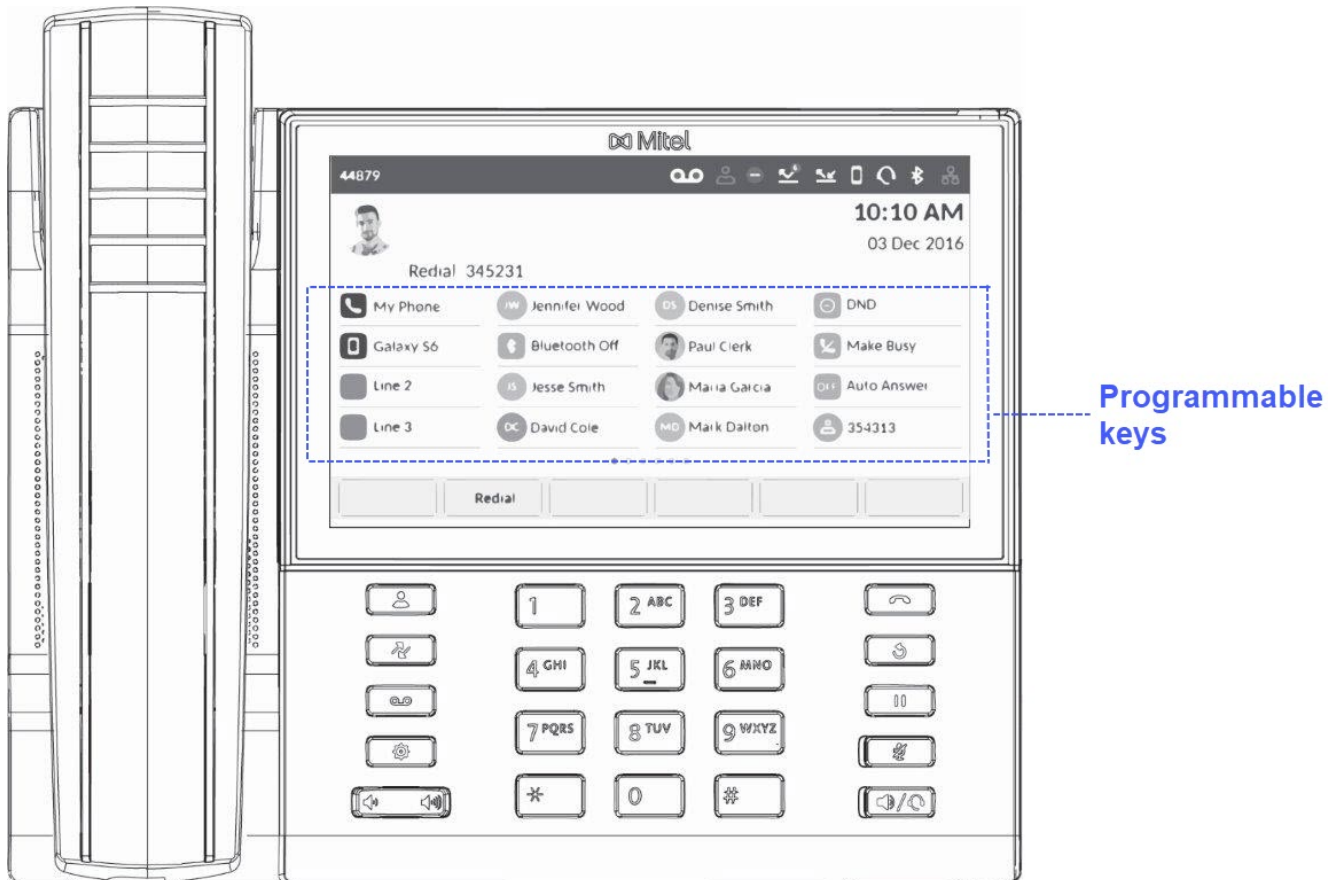

NOTE:

1. If Mitel M695 Programmable Key Modules (PKMs) are attached to the phone, you can configure up to an additional 28 keys on each PKM.
2. The Mitel MiVoice 6940 IP phone allows up to three PKMs on each phone. For more information about PKMs, see [“Mitel M695 Programmable Key Module \(PKM\)”](#).

If enabled by your System Administrator, you can program or edit the following functions on the programmable keys by pressing and holding the respective programmable key for the configured duration:

- Speed Call
- Phone Lock
- Call Forward Always
- Mobile/PC Line
- Account Code Non Verified
- Account Code Verified

NOTE: Programming keys using the press-and-hold method is dependent on your Class of Service settings defined for your account on the MiVoice Business call server.

PKM LED Indicator

If a M695 PKM key is configured as a line key, the LED beside the key indicates the line status. The LED turns ON (solid red) when the line is active, turns OFF when the line is idle, and blinks (blinking red) when the line is ringing.

Speed Call

The **Speed Call** key allows you to dial a specified number with one tap of the key. **Speed Call** keys can be useful as they can be programmed to dial external numbers, dial directly to another person's extension or quickly access features that use feature access codes. You can also transfer calls to or create conference calls using your **Speed Call** keys in place of dialing out manually.

To program or edit a **Speed Call** key:

1. Press and hold the applicable programmable key for the configured duration.

The screenshot shows a mobile application interface for configuring a programmable key. At the top, there is a dark blue header with the text "Programmable Key". Below this, a light blue sidebar contains three options: "Speed Call" (which is selected and highlighted), "Other Features", and "More ...". The main content area is white and contains the following fields and controls: a "Label Name" text input field, a "Number" text input field with a blue border, and a "Private" checkbox. At the bottom of the screen, there is a row of six softkey buttons: "Save", "Backspace", "Pause", "Flash", "Backspace", and "Cancel".

2. In the **Label Name** field, enter a label to apply to the key using the on-screen keyboard.
3. Tap the **Number** field and enter a number using the dialpad keys.
4. (Optional) Tap the **Private** checkbox to make the key a **Private Speed Call** key. When a **Private Speed Call** key is tapped, the call is considered private and caller ID information is not displayed in the phone's call history.
5. Tap the **Save** softkey to save the information to the key you selected.

To make a speed call, tap the key that you have programmed with **Speed Call** functionality.

Other Features

Phone Lock

By programming a **Phone Lock** key you can lock your phone to prevent the phone from being used or configured. **Phone Lock** prevents access to all the features on the phone, with the following exceptions:

- Unlocking the set via a user PIN.
- Hot Desk Login and Logout support.
- Emergency Call Notification support.

Phone Lock has no effect on incoming calls but restricts outgoing calls, with the following exceptions:

- Calls to emergency trunk routes.
- Local operators.

All hard keys on the device are disabled except for the dialpad and volume keys. All programmable keys and softkeys are disabled except for the **Phone Lock**, **Hot Desk**, and Emergency Notification feature access keys.

To program a **Phone Lock** key:

1. Press and hold the applicable programmable key for the configured duration.
2. Tap **Other Features**.
3. Tap **Phone Lock**.

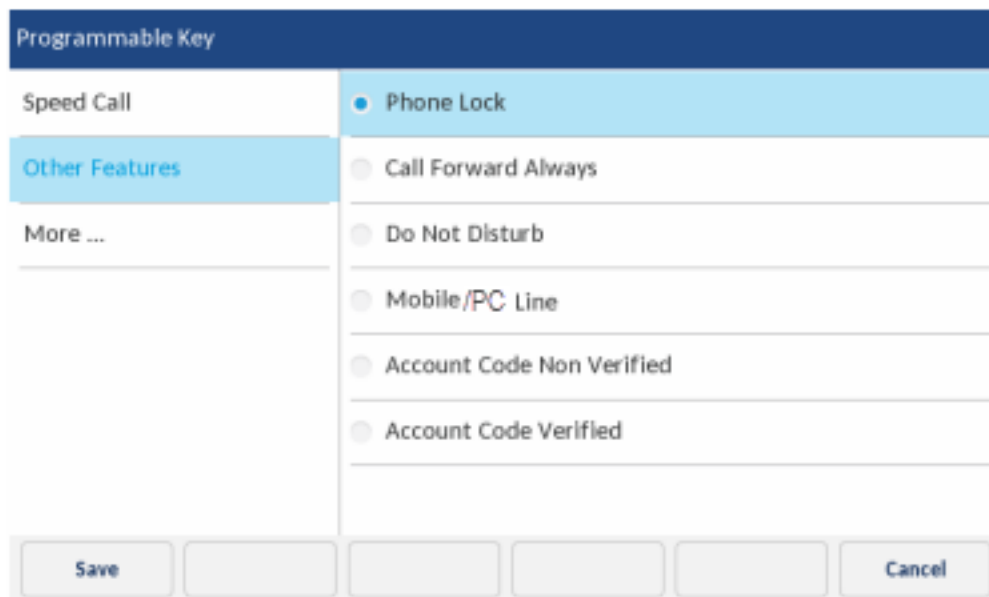

4. Tap the **Save** softkey.

To lock the phone:

1. Tap the **Phone Lock** key.
A "Locked" prompt appears on screen and the **Phone Lock** key turns light blue indicating the phone is locked.

NOTE: When the phone is in “Locked” state, a lock icon will appear on the screensaver.



To unlock the phone:

1. Tap the **Phone Lock** key again.
2. At the "Enter PIN:" prompt, enter your pin number using the dialpad keys and tap the **Enter** softkey.

Call Forward Always

Programming a **Call Forward Always** key allows you to quickly enable and disable call forwarding for all calls on your phone even if you have other call forward modes enabled through your **Call Forward** settings menu.

For example, you can enable settings to forward calls to your voicemail when your phone is busy or unanswered. Then, when you leave your desk, you can quickly enable **Call Forward Always** to forward calls to another phone, such as your home phone or cell. After you return to your desk and disable **Call Forwarding Always**, the defaults for busy or unanswered conditions remain active.

To program a **Call Forward Always** key:

1. Press and hold the applicable programmable key for the configured duration.
2. Tap **Other Features**.
3. Tap **Call Forward Always**.

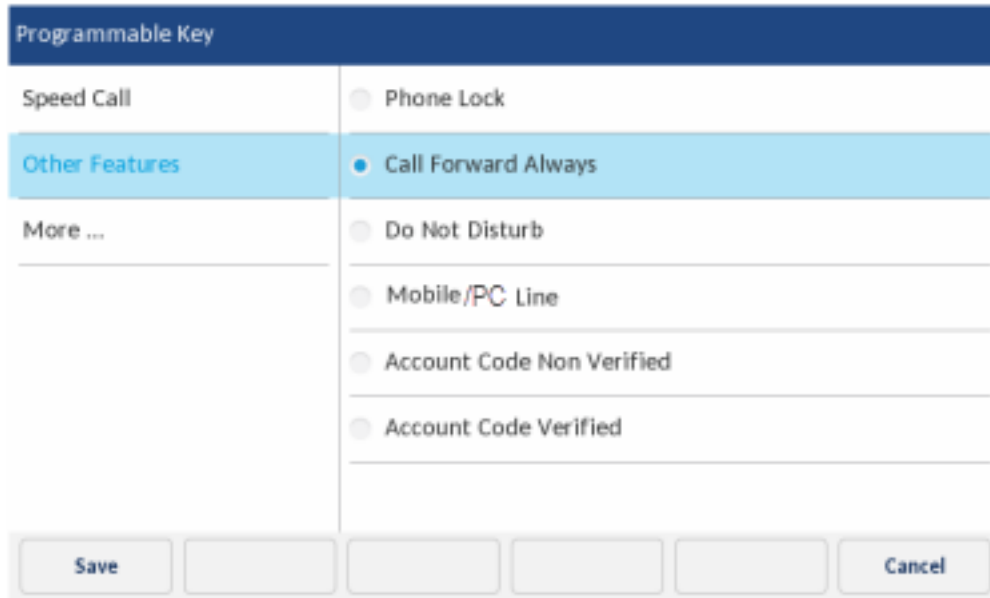

4. Tap the **Save** softkey.

To enable **Call Forward Always**:

1. Press the key that you have programmed with **Call Forward Always** functionality. When Call Forward

Always is enabled, a  (**Call Forward Always**) icon is displayed in the status bar.

2. If a number is already programmed, tap **Activate** to enable forwarding to the current number
or

If a number has not been programmed, enter a new destination number using the dialpad keys and then tap the **Activate** softkey.

NOTE:

- a. When **Call Forward Always** is enabled, it takes precedence over all other types of call forwarding.
- b. If **Call Forward Always** is enabled, then the **Call Forward Always** icon is displayed on the Screen Saver.
- c. If both **Call Forward Always** and **DND** are enabled, then the **DND** icon is displayed on the Screen Saver

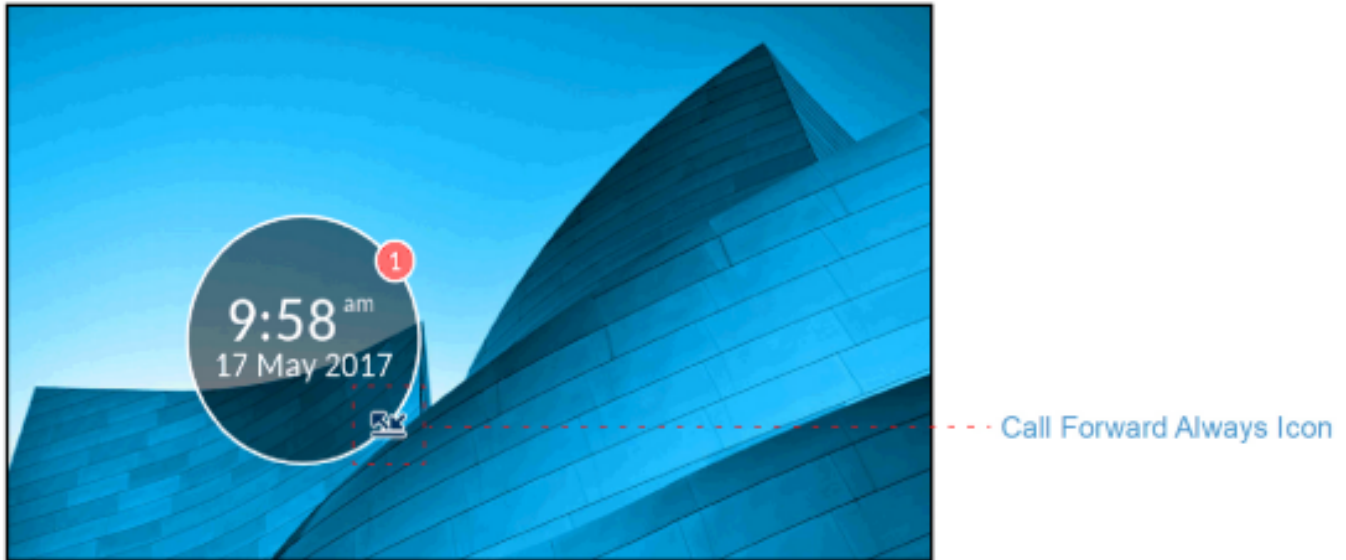

To disable **Call Forward Always**:

1. Press the key that you have programmed  **Call Forward Always** functionality. When Call Forward Always is disabled, a  (**Call Forward Always**) icon is removed from the status bar.
2. Tap the **Deactivate** softkey.

NOTE: When **Call Forward Always** is disabled, the default call forwarding settings are active.

Do Not Disturb

When you program and enable a **Do Not Disturb** key, callers may get a busy tone and an on-screen text message indicating that you do not wish to be disturbed, depending on the setting in the System Administrator Tool.

To program a **Do Not Disturb** key:

1. Press and hold the applicable programmable key for the configured duration.
2. Tap **Other Features**.
3. Tap **Do Not Disturb**.

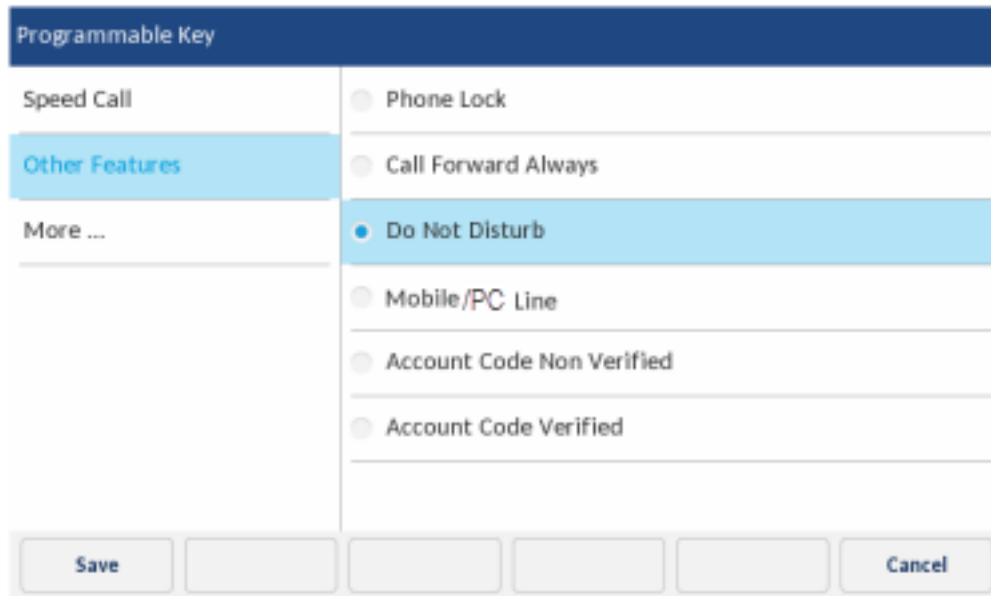

4. Tap the **Save** softkey.

To enable **Do Not Disturb**:

1. Tap the key that you have programmed with **Do Not Disturb** functionality.
When DND is enabled, a  (**DND**) icon is displayed in the status bar and the **Do Not Disturb** key turns red.

NOTE: The **DND** icon is displayed on the Screen Saver.



To disable **Do Not Disturb**:

1. Tap the key that you have programmed with **Do Not Disturb** functionality.
When DND is disabled, the  (**DND**) icon is removed from the status bar and the **Do Not Disturb** key returns to its normal color.

Mobile/PC Line

The Mitel MiVoice 6940 IP Phone supports **Mobile/PC Line**, a feature that provides seamless mobile integration using Bluetooth wireless technology. This feature allows you to:



- Sync your mobile phone’s contact list and call history with your Mitel MiVoice 6940 IP phone.
- Answer a mobile phone call using your Mitel MiVoice 6940 IP phone.
- Move mobile call audio between the Mitel MiVoice 6940 IP phone and your mobile phone.





You can enable **Mobile/PC Line** feature by one of the following ways:

- Programming a **Mobile/PC Line** key for your phone by your System Administrator. Contact your System Administrator for details on how to enable MobileLink functionality on your phone.
- Pressing and holding a programmable key.



The **Mobile/PC Line** key icon changes to reflect the status of the line as per the following table.

Icon	Description
	Indicates the mobile/PC line is connected with a mobile phone and is idle.
	(Blinking) Indicates the mobile/PC line is ringing due to an incoming call on your mobile phone.

	Indicates the mobile/PC line is busy.
	(Blinking) Indicates an ongoing call with active audio on the mobile phone.
	(Blinking) Indicates the call on the mobile/PC line is on hold.
	Indicates the mobile phone is not connected.

To program a **Mobile/PC Line** key:

NOTE: You can program only one **Mobile/PC Line** key.

1. Press and hold the applicable programmable key for the configured duration.
2. Tap **Other Features**.
3. Tap **Mobile/PC Line**.

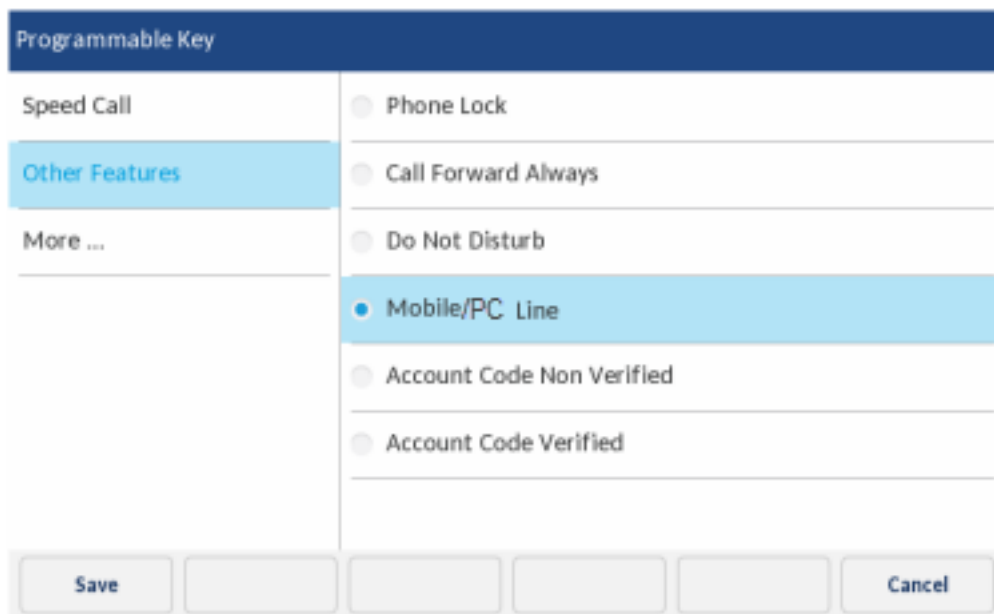

4. Tap the **Save** softkey.
5. With **Mobile/PC Line** highlighted, press the **Save** softkey.

For more information on how to use the **Mobile/PC Line** key, see [“MobileLink”](#).

Account codes

Accounts codes are an effective way of grouping calls together for accounting, auditing, and reporting purposes. When you tag a call with an account code, the code is picked up in the records generated by

your call server. This allows System Administrators the ability to quickly identify groups of calls, which can then be used by different departments for organizational and reporting purposes.

The following are the two types of account codes that you can add to a call:

- **Account Code Non Verified:**

A non-verified account code is one that has not been pre-programmed on your call server. Non-verified account codes can be used to group a set of calls that has not yet been verified and pre-programmed on your call server.

- **Account Code Verified:**

A verified account code is one that has been pre-programmed on your call server by a System Administrator.

Account Code Non Verified

To program an **Account Code Non Verified** key:

1. Press and hold the applicable programmable key for the configured duration.
2. Tap **Other Features**.
3. Tap **Account Code Non Verified**.

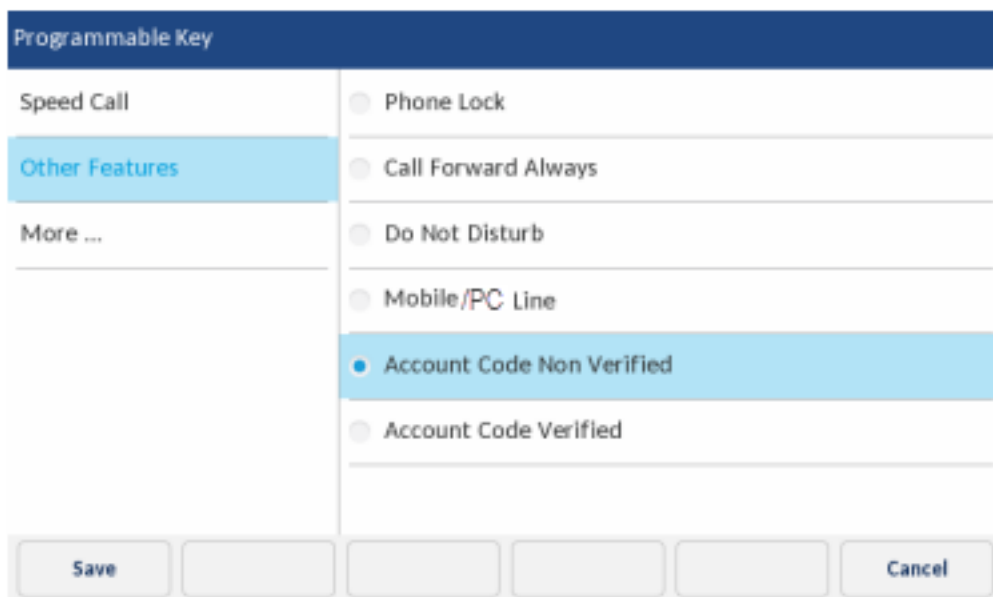

4. Tap the **Save** softkey.

To assign a non-verified account code before a call:

1. Tap the key that you have programmed with **Account Code Non Verified** functionality.
2. Enter the digits (up to 12) for the account code using the dialpad keys.
3. Press the # (hash) key.
4. Enter the number you wish to call.

To assign a non-verified account code during a call:

1. While on an active call, tap the key that you have programmed with **Account Code Non Verified** functionality.
2. Enter the digits (up to 12) for the account code using the dialpad keys.
3. Press the # (hash) key.

Account Code Verified

To program an **Account Code Verified** key:

1. Press and hold the applicable programmable key for the configured duration.
2. Tap **Other Features**.
3. Tap **Account Code Verified**.

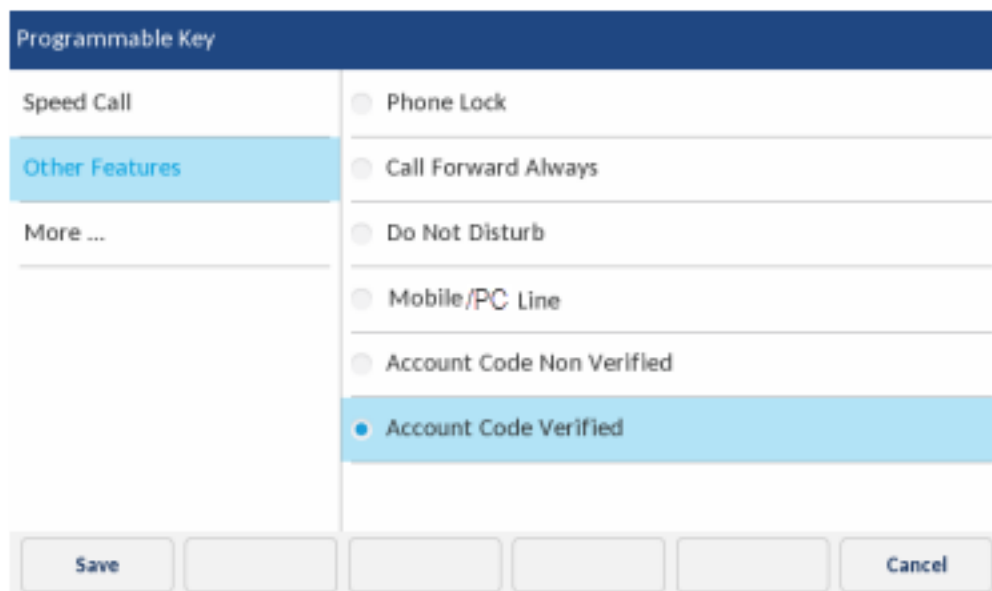

4. Tap the **Save** softkey.

To assign a verified account code before a call:

1. Tap the key that you have programmed with **Account Code Verified** functionality.
2. Enter the digits (up to 12) for the account code using the dialpad keys.
3. Press the # (hash) key.
4. Enter the number you wish to call.

To assign a verified account code during a call:

1. While on an active call, tap the key that you have programmed with **Account Code Verified** functionality.
2. Enter the digits (up to 12) for the account code using the dialpad keys.
3. Press the # (hash) key.

Float Keys

The Mitel MiVoice Business 6940 IP Phone offers 96 programmable, multi-function, self-labeling keys and six intuitive state sensitive softkeys. You can program eight of these keys as Float keys. Float keys are used to display unanswered ringing lines on designated keys where the ringing lines would otherwise be hidden on one of the phone’s application pages. The location of the Float keys is shown in the following figure.

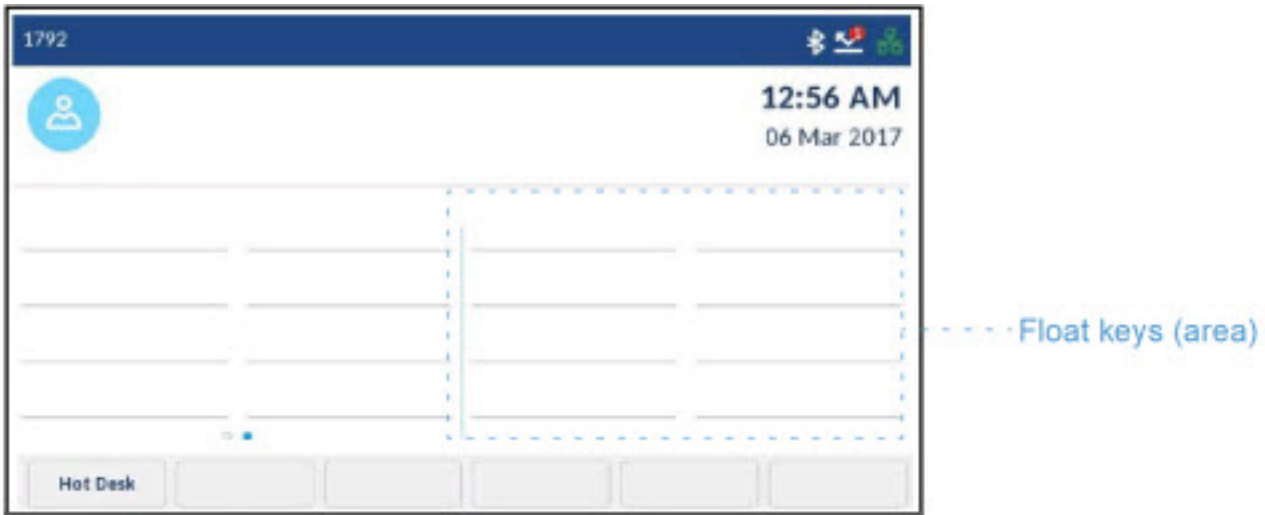

Up to eight concurrent incoming calls with associated labels can appear on the Float keys. Float keys can also be used to support ringing line queues – due to the number of ringing lines at any one time, you are able to view the queue of unanswered “floated” lines, and answer them as quickly as possible.

Only the following line types are supported for Float keys on the 6940 IP Phone:

- Single Line
- Key System
- Multicall

When Float keys are set up, a separator line appears separating Float keys area and programmable keys area. Switching between programmable key pages is limited to the programmable keys area.



Using Float Keys

You can set up more than eight lines to float. As lines ring, they get placed into a queue which will display the first eight in the Float key area. If there are more than eight lines configured to float, as Float Key positions are freed up, the next lines in the queue get displayed. Press the Float key of the ringing line to answer a call.

Contact your System Administrator to program Float keys on your 6940 IP Phone.

Making calls

This section describes ways to make calls on your Mitel MiVoice 6940 IP phone, using your handset, speakerphone or headset.

Dialing a number

First, take the phone off-hook by either:

- Lifting the handset (if the handset is on the cradle) for handset operation.
- Pressing the hookswitch key located on the side of the handset (if the handset is not on the cradle) for handset operation.
- Pressing the  (**Speaker/Headset**) key or tapping the applicable **Line** key for speaker or headset operation. Your phone must be configured to use the **Speaker** audio path for speaker operation or **Headset** audio path for the headset operation.

At the dial tone, enter the number you wish to call. When your party picks up, a timer appears on your display that records the length of your call.

Alternatively, you can enter the number you wish to call without taking the phone off-hook. This method of dialing will use the speakerphone or headset audio path depending on the audio path setting you selected in the **Settings > Audio > Audio Path** menu. For more information, see the section [“Audio Path”](#).

NOTE: When dialing, press the **Backspace** softkey to delete the last digit entered. To cancel the dialing process, press the **End Call** softkey or the  (**Goodbye**) key.

If the dialed number matches with a contact stored in the **Personal**, **Mobile** or **Corporate** folder in the **Contacts** application, then the contact name is displayed. The contact name look up is in the following order:

1. Personal Contacts, where respective Personal Contacts name is displayed.
2. Mobile Contacts, where respective Mobile Contacts name is displayed.
3. MiVoice Business System Contacts, where if the MiVoice Business System is configured with MiNET Phone Object Message Name, then the respective MiVoice Business System name is displayed.
4. Corporate Contacts, where respective Corporate Contacts name is displayed.

If there is no match, then the name returned by the MiVoice Business system is displayed.

If you are unable to make calls within certain area codes, check with your System Administrator for any toll restrictions placed on your extension that may restrict your access to long distance area codes or dialing prefixes.

Initiating a callback

The callback feature allows you to be notified when a busy phone becomes free or when a phone has been used after a no-answer condition was encountered.

To request a callback when the call you initiated is busy or has not answered:

1. Tap the **Call Me Back** softkey.
2. Hang up.

When the party is available, your phone starts ringing, and the display shows the callback ringing indicator.

To answer a callback when you see the callback ringing indicator:

1. Lift the handset, press the  (**Speaker/Headset**) key, or tap the applicable **Line** key, or tap the Float Key (see [Float Keys](#)).

Redialing a number

You can redial the most recently dialed number that is displayed on the **Home** screen by pressing the **Redial** hard key twice or by tapping the **Redial** softkey.

Pressing the **Redial** hard key once accesses the **Outgoing** calls list in the **Call History** application. For more information on the **Call History** application, see ["Call History"](#).

Receiving calls

When a call is ringing at your extension, the callers name, number, and avatar (if applicable) display on the **Call** screen. Additionally, the applicable **Line** key icon flashes indicating the incoming call.

If the incoming number matches with a contact stored in the **Personal**, **Mobile** or **Corporate** folder in the **Contacts** application, then the contact name is displayed. The contact name look up is in the following order:

1. Personal Contacts, where respective Personal Contacts name is displayed.
2. Mobile Contacts, where respective Mobile Contacts name is displayed.
3. MiVoice Business System Contacts, where if the MiVoice Business System is configured with MiNET Phone Object Message Name, then the respective MiVoice Business System name is displayed.
4. Corporate Contacts, where respective Corporate Contacts name is displayed.

If there is no match, then the name returned by the MiVoice Business system is displayed.



Answering an incoming call

To answer an incoming call:

- If the handset is on the cradle, lift the handset for handset operation.
- If the handset is not on the cradle, press the hookswitch key located on the side of the handset for handset operation.
- For speakerphone operation, press the  (**Speaker/Headset**) key, or tap the applicable **Line** softkey, or Float Key (see [Float Keys](#)). Your phone must be configured to use the Speaker audio path.

- For headset operation, press the  (**Speaker/Headset**) key or the answer button on your headset (if available). Your phone must be configured to use the Headset audio path.

NOTE: The audio path setting you selected in the **Settings > Audio > Audio Path** menu determines if the call goes to the speakerphone or headset. For more information, see the section [“Audio Path”](#).

Manually forwarding an incoming call

If call forwarding numbers have been defined for the **Always** or **No Answer** states, tap the **Forward Call** softkey to manually forward an incoming call to the defined number. A common way of using this feature is to configure call forwarding to forward calls to your voicemail service. You can then manually decide whether to answer an incoming call or send the call to voicemail.

NOTE:

1. The number defined for the **Always** state has precedence over the numbers defined for the **No Answer** states.
2. For more information on how to configure the **Call Forward** feature, see the section [“Call Forward”](#).



Handling calls

When you are connected to a call, you can use hard keys on the phone to perform various actions, such as placing a call on hold or muting the microphone. Softkeys can also be used to perform actions such as transferring calls or creating multi-party conference calls.

Placing a call on hold

You can place an active call on hold by pressing the  (**Hold**) key.

To place a call on hold (while on an active call):

1. Press the  (**Hold**) key.
Your applicable **Line** key flashes the  (**Hold**) icon indicating the call is on hold. To let your caller know that they are on hold, music plays softly (if this has been set up on your call server).



NOTE: After a prolonged period of time on hold, the held call may automatically switch to an incoming call to remind you that the call was on hold.



2. To retrieve a call on hold, tap the applicable **Line** key or Float Key (see page 64).

Muting the microphone

You can use the  (**Mute**) key to mute the microphone on the handset, headset, or speakerphone.

When you use the  (**Mute**) key on your phone, you cannot be heard on an active call or on a conference.

You can also mute the microphone on the handset, by pressing the handset's mute key located between the handset's volume control keys.

To indicate a muted microphone, the LED beside the  (**Mute**) key turns on. To switch mute on or off, press the  (**Mute**) key.

NOTE: If you place a muted call on hold, the phone automatically takes the call off mute when you reconnect to the call.

Transferring a call

There are two types of call transfers that can be performed on the Mitel MiVoice 6940 IP phone:

- **Unattended Transfer:**
An unattended transfer is when you transfer a call directly to another extension without consulting with the person receiving the call. To do this, complete the transfer immediately after you have entered the number. The call goes directly to the extension or outside line to which you transferred.
- **Attended transfer:**
You also have the option to consult with the person to which you are transferring the call, before you complete the transfer. To do this, remain on the line until the receiving party answers the call. After consulting with the receiving party, you can either complete the transfer or cancel the transfer to go back to the original call.

To transfer a call:

1. Ensure you are on active call with the party you wish to transfer.

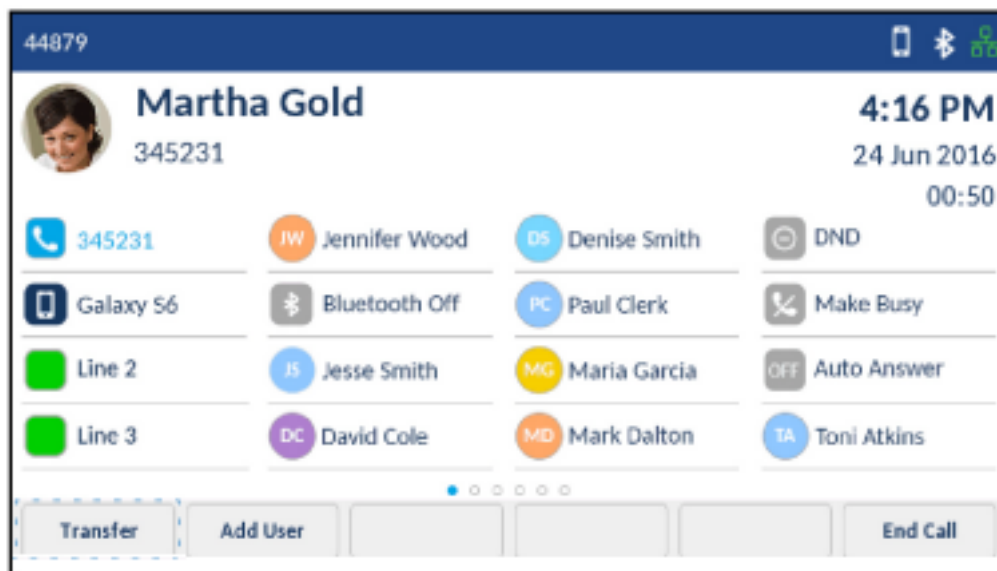

2. Tap the **Transfer** softkey.

The active call is placed on hold.

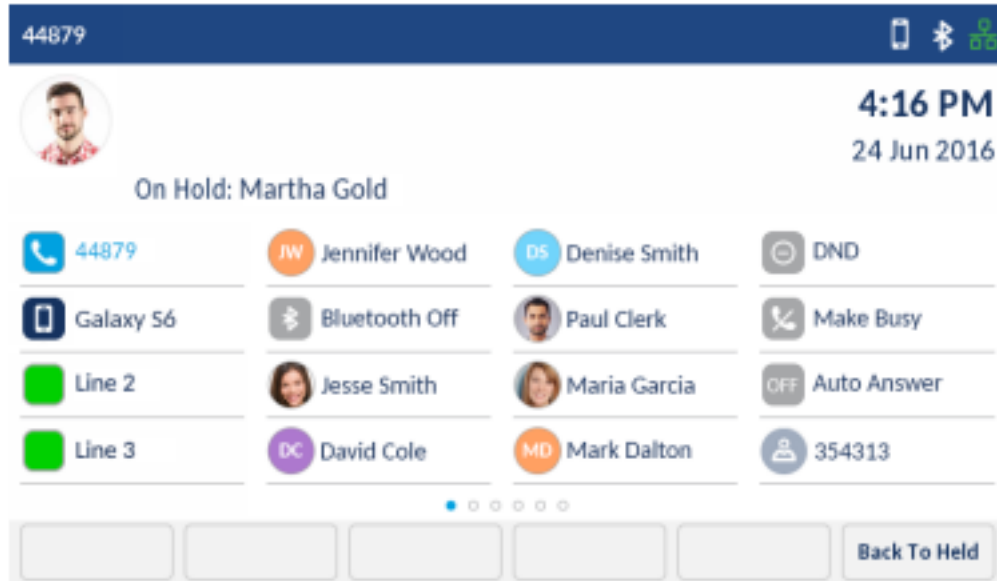

3. Enter the transfer recipient's number.



4. Tap the **Transfer** softkey or hang up the handset to complete an unattended call transfer
or
Wait for an answer, consult, and then tap the **Transfer** softkey or hang up the handset to complete an attended transfer.

Creating a multi-party conference call

The Mitel MiVoice 6940 IP phone supports multiples parties in a conference call.

To create a multi-party conference call:

1. Ensure you are on active call with one of the parties with whom you wish to create a conference.

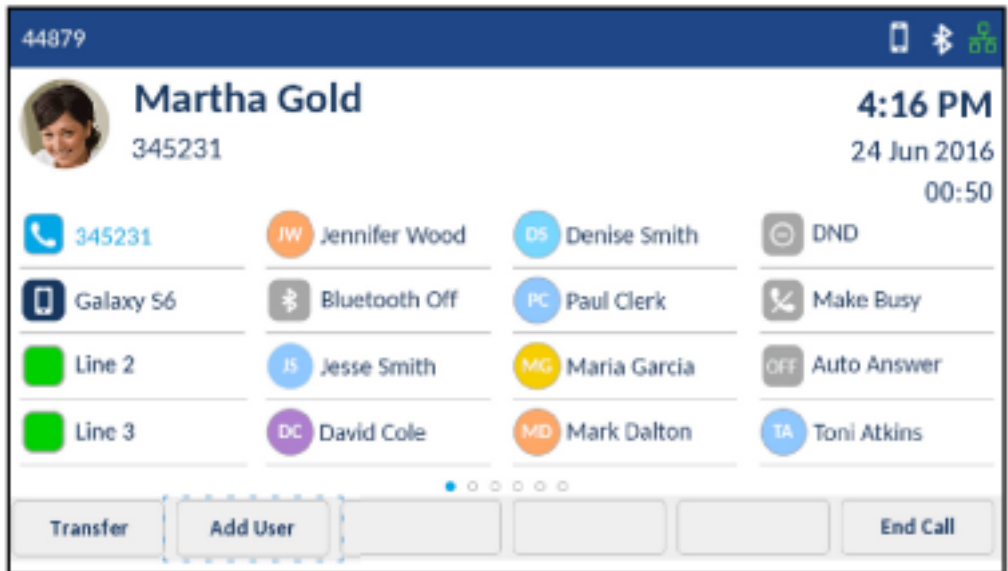

2. Tap the **Add User** softkey.

The active call is placed on hold.

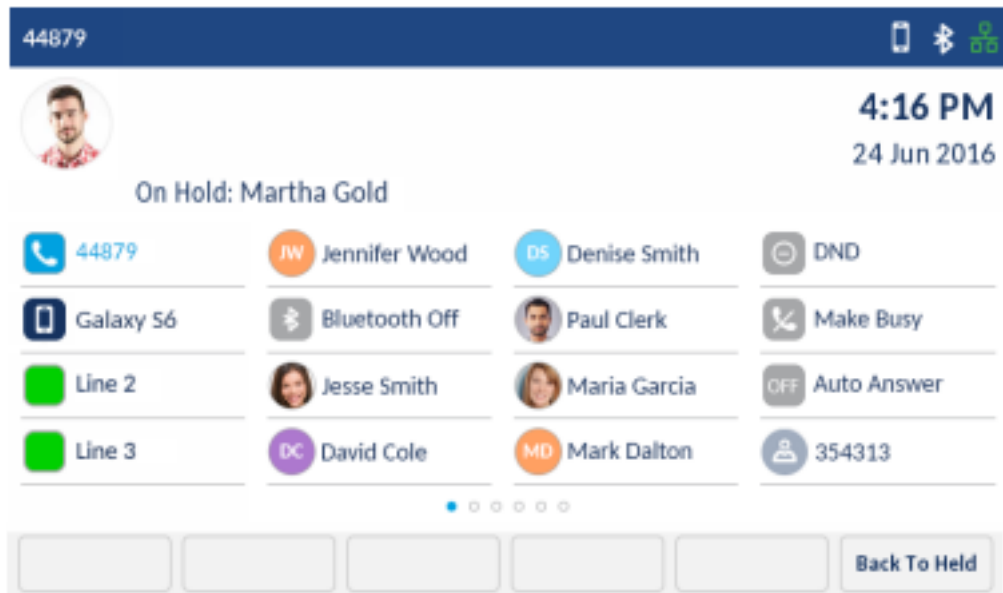

3. Enter the conference target's number.

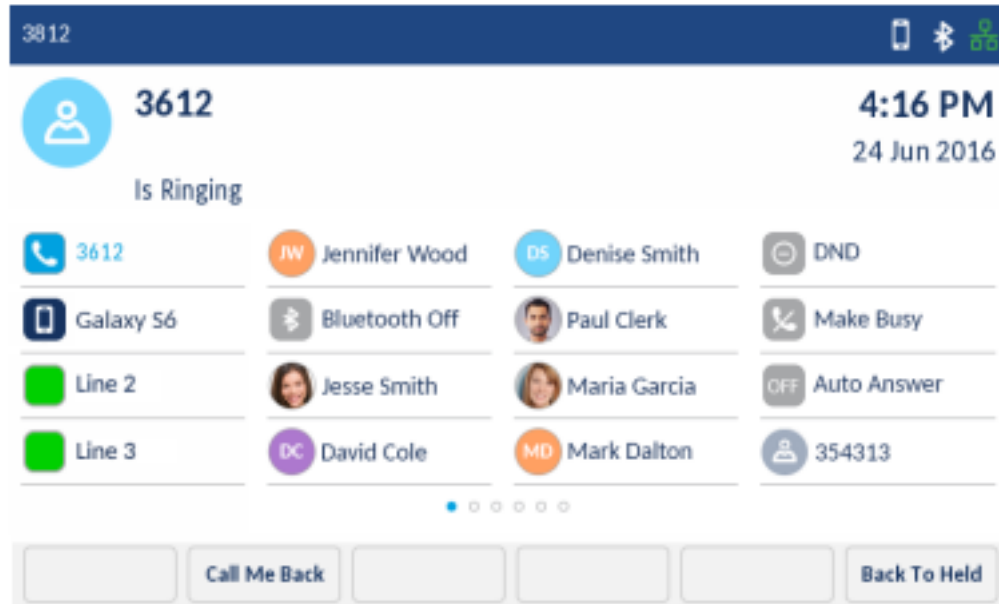

4. Wait for an answer, consult, and then tap the **Join Calls** softkey to create the three-way conference call.

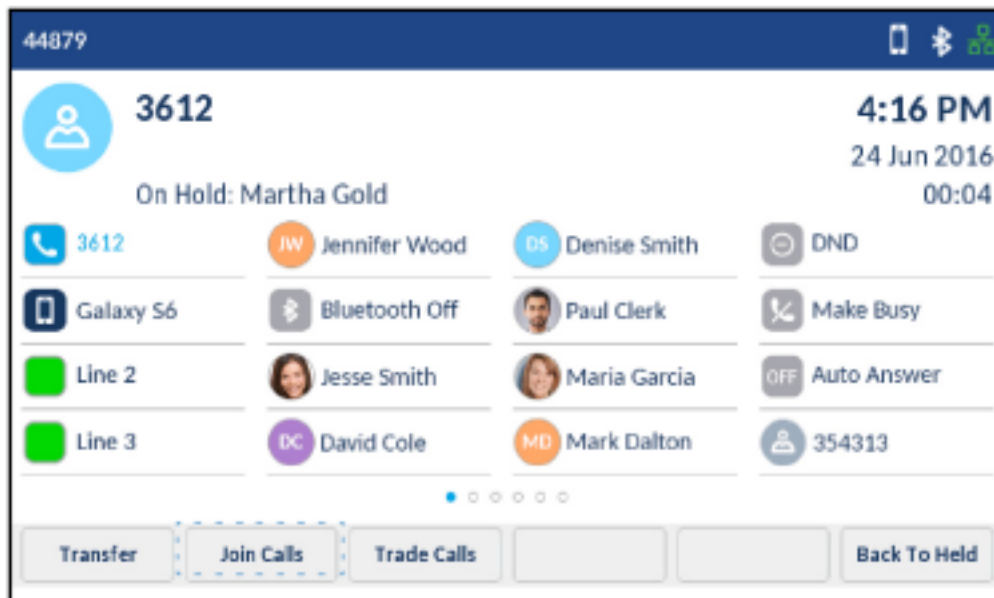

NOTE:

- a. Tapping the **Trade Calls** softkey swaps the active call with the other party currently on hold.
- b. Tapping the **Split** softkey splits the conference call by placing all callers on hold except for the initial caller.

5. Repeat steps 2 to 4 to add additional parties to the conference.

NOTE: If you want to create a conference call with two parties you are already in calls with (on different line appearances), tap the **Add Held** softkey and then tap the applicable **Line** key with the held call.

Ending a conference and transferring remaining parties

The Mitel MiVoice 6940 IP phone allows a host to easily leave a conference call without disrupting the connection of the other remaining parties.

If you are the host of a conference call and want to leave the conference, tap the **Leave Call** softkey on the phone. Your phone leaves the conference call but the remaining parties are still connected together.

Ending calls

To end a call, you first need to connect or reconnect to the call if not already connected (e.g. if your caller is on hold). With the call connected, place the handset on its cradle, tap the **End Call** softkey, or press

the  (**Goodbye**) key. Pressing the hookswitch button located on the side of the handset also ends an active call.

Managing calls

The Mitel MiVoice 6940 IP phone has several features that make it easier to manage calls. Three of the main call management features include the **Contacts** application, the **Call History** application, and **Voicemail**.

Contacts

The **Contacts** application is your personal phone book and directory, conveniently stored within your phone. The Mitel MiVoice 6940 IP phone supports a localized **Personal** contact folder as well as enhanced functionality allowing for interoperability with LDAP (**Corporate**) directories. The phone also supports MobileLink synchronization with mobile phone contact lists using Bluetooth capabilities.

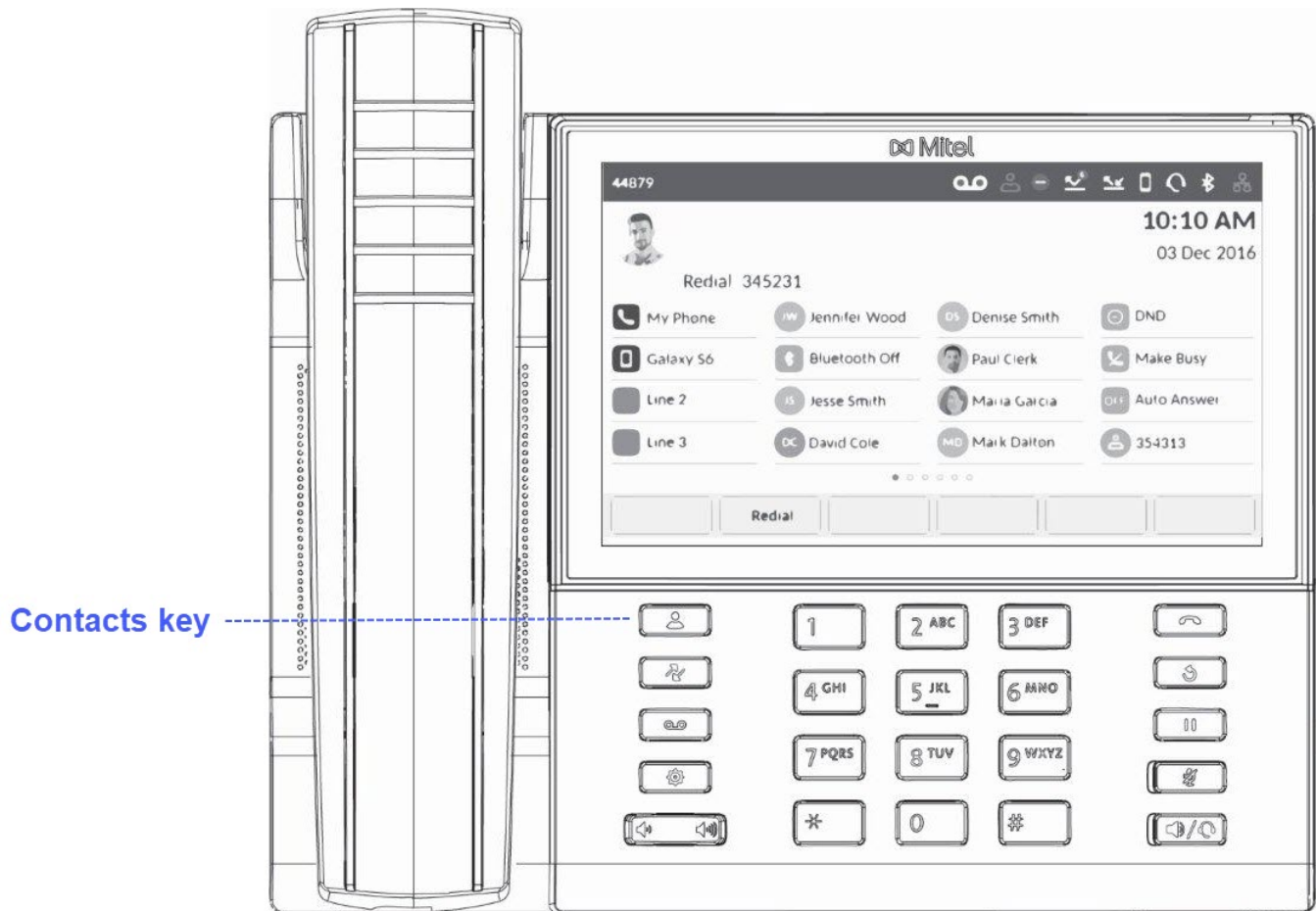

NOTE:

1. Access to Corporate directories must be set up by your System Administrator.
2. For more information on syncing mobile contacts and MobileLink functionality, see [“Syncing mobile contacts”](#).

General functions

Accessing and navigating the Contacts application

To access and navigate the Contacts application:

1. Press the  (**Contacts**) key.

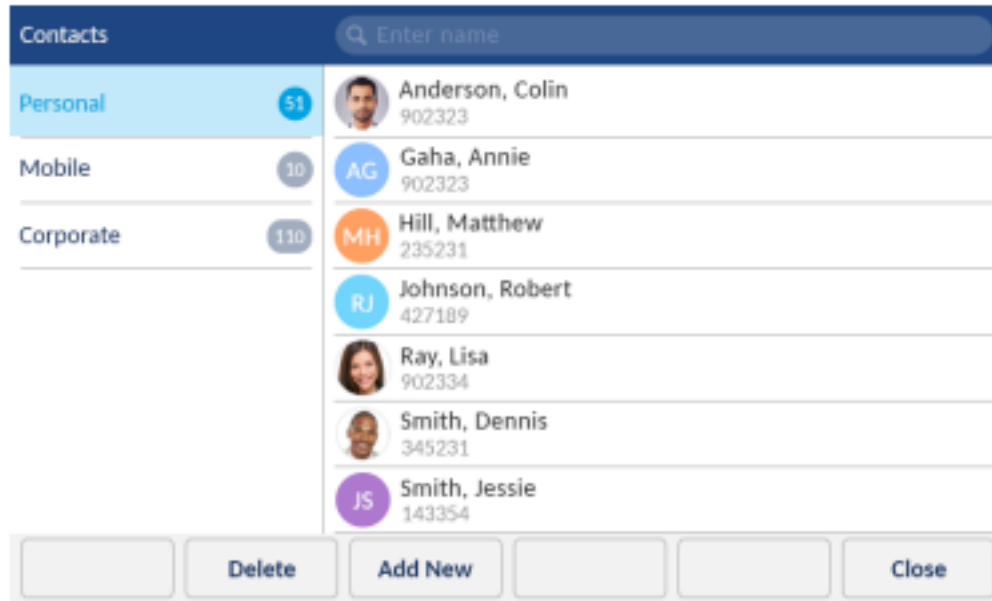

2. Tap the contact folder you wish to view.
NOTE: If any of the folders are empty, a "Directory empty" message displays on screen.
3. Swipe up and down to scroll through the list of contacts.
4. Tap to select a contact.

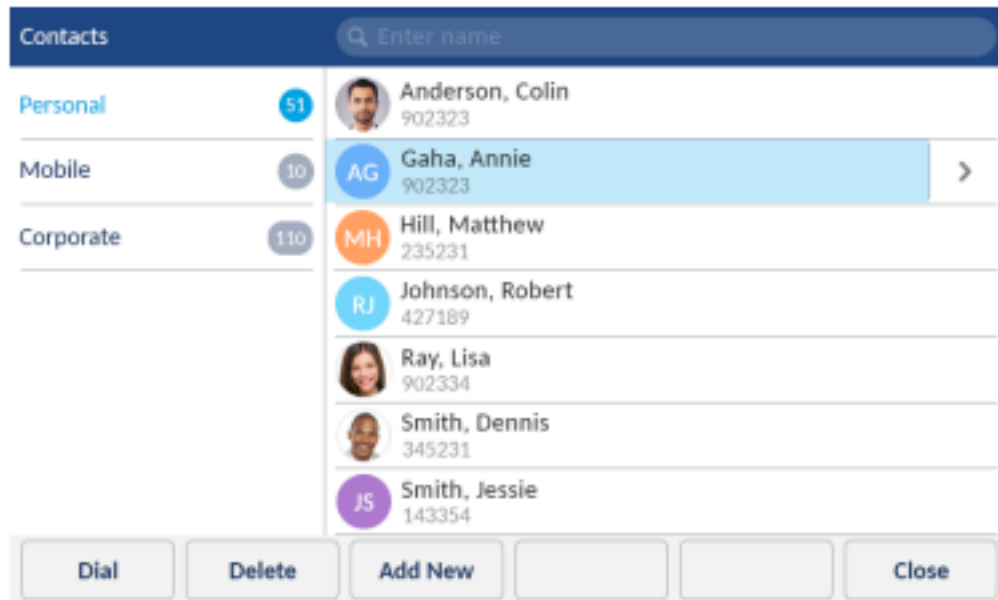

- With the respective contact selected, tap the right arrow button to view the contact's contact card.

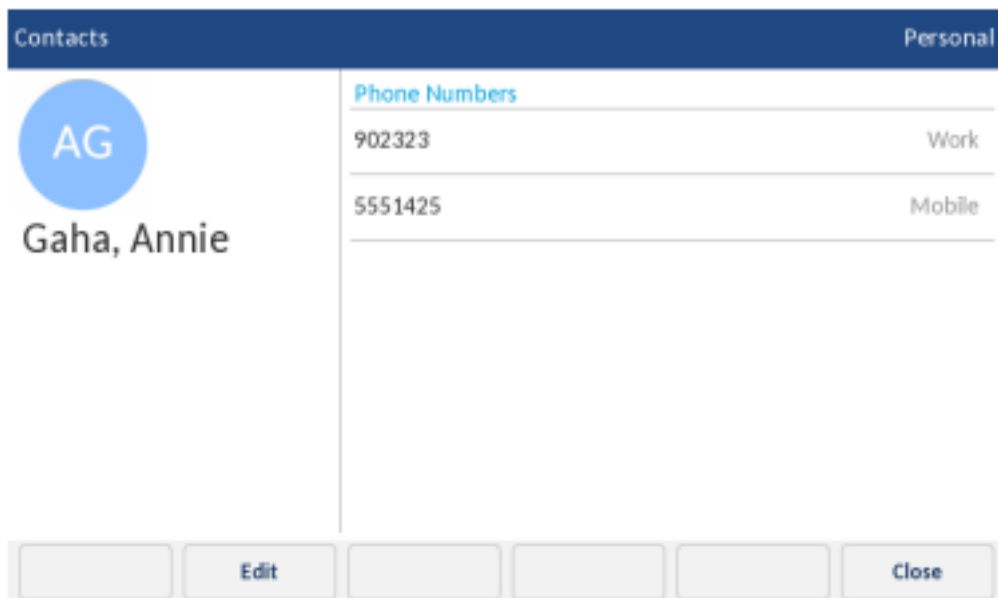

- Tap to select a number.
- Press the  (**Goodbye**) key, or **Close** softkey to exit.

Performing a search

Search functionality is applied to your **Personal** and **Mobile** contact folders and your **Corporate** contact folder if your corporate directory is configured to be cached.

NOTE: If you do not see a number indicating the amount of contacts beside your **Corporate** folder, your corporate directory is configured to be non-cached. See [“Performing a search on a non-cached Corporate contact folder”](#) if your phone is configured to use a non-cached corporate directory.

Pressing on any dialpad key or tapping on the search bar initiates the search. After entering the first few letters of the contact’s first name or last name and initiating the search, you can then quickly select a contact and perform the applicable action. Use the following procedure on the phone’s UI to perform a search.

To perform a search:

1. Press the  (**Contacts**) key.

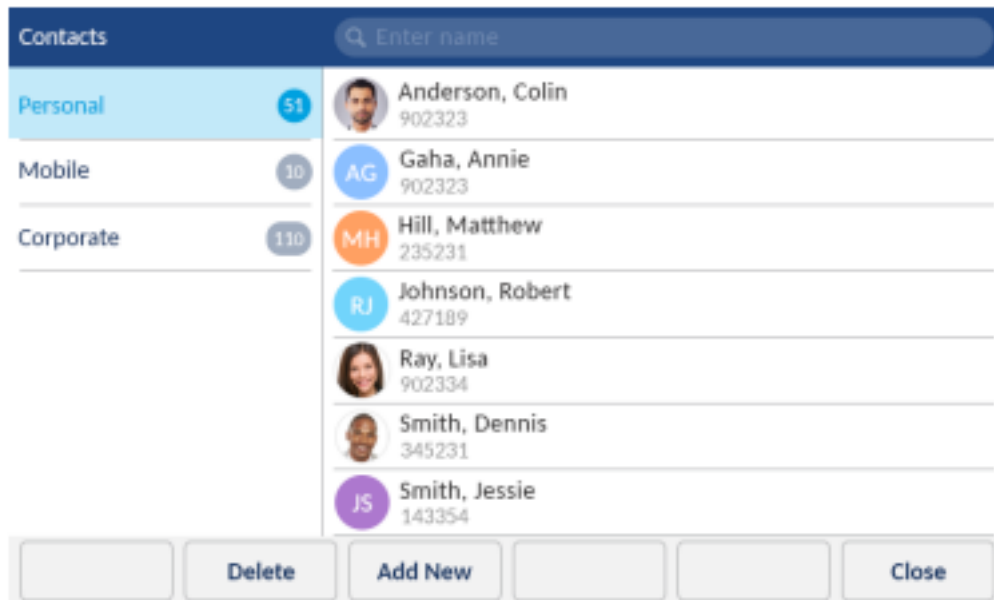

2. Tap the search bar.
3. Enter the first letters of the contact’s name using the on-screen keyboard and (if required) tap the blue return button.

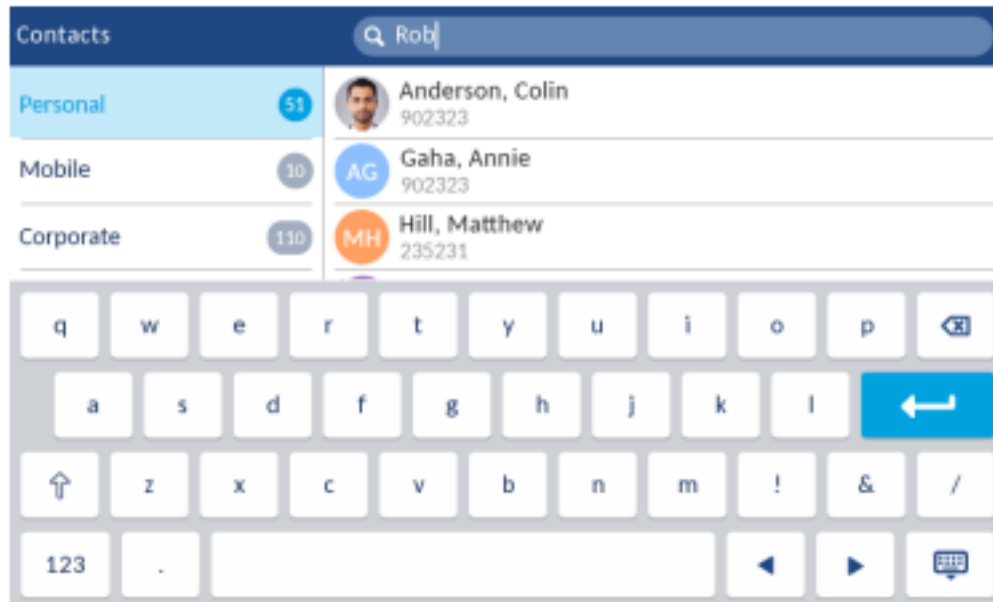

NOTE: Hide the keyboard and press the **Reset** softkey at any time clear the search field.

4. When matches are found, tap the applicable contact entry and perform your desired action.

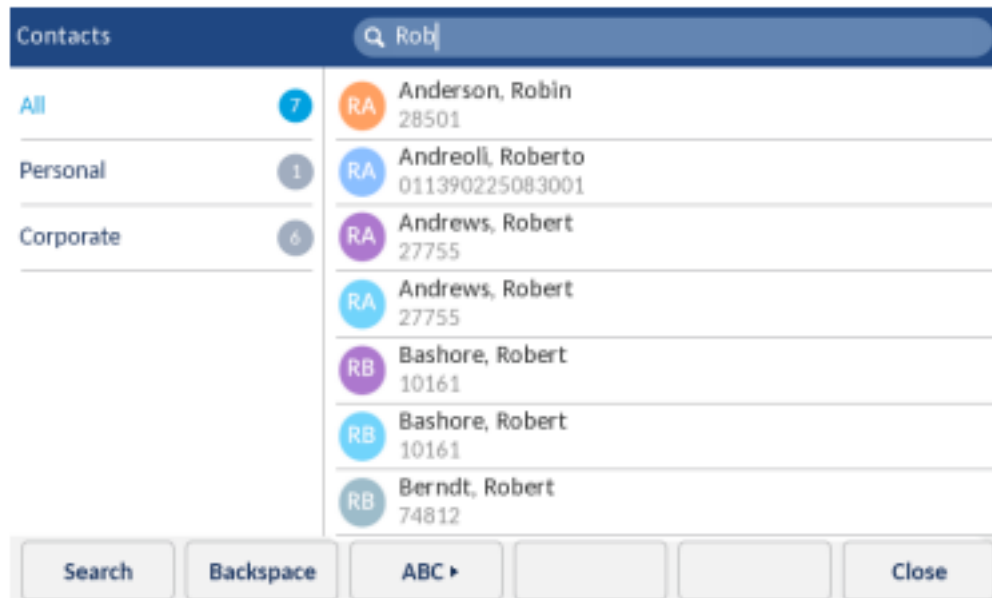

Dialing from the Contacts application

Dialing can be performed by manually navigating to the contact, selecting a phone number (if the contact has more than one) and then by picking up the handset, or by pressing the **Dial** softkey, **Select** button

or  (**Speaker/Headset**) key.

To dial a contact's phone number.

1. Press the  (**Contacts**) key.
2. (Optional) Tap the search bar, enter the first letters of the contact's name, and tap the blue return button to initialize the search function.
3. Tap the contact you want to call.

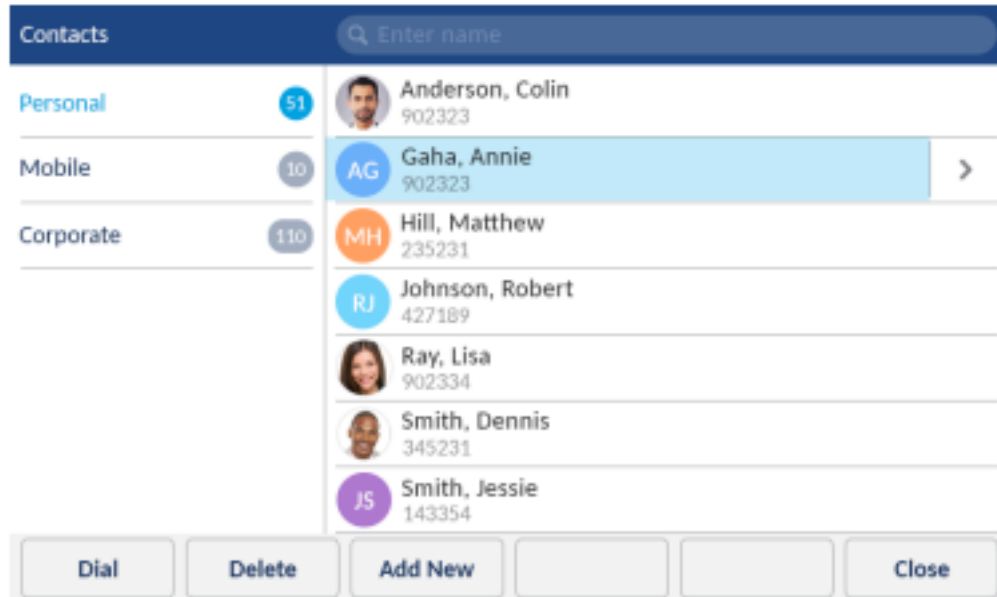

4. (Optional) If the contact has multiple phone numbers defined, press the right arrow button to navigate to the contact card and tap the phone number you wish to call.
5. Tap the **Dial** softkey or press the  (**Speaker/Headset**) key for speaker or headset operation
or
or Pickup the handset for handset operation.

Personal folder features

The **Personal** folder contains the contacts (up to 50) that have been created or copied directly to the phone using the phone UI.

From the **Personal** folder you can search for a personal contact, place a call to the selected personal contact, add new personal contacts, delete all personal contacts, delete individual personal contacts, or edit existing personal contacts. You can also view contact details (e.g. avatar, name, and numbers) by navigating to the contact card.

Adding a new contact to your Personal folder

To add a new contact to your **Personal** folder:

1. Press the  (**Contacts**) key.
2. Tap the **Add New** softkey.

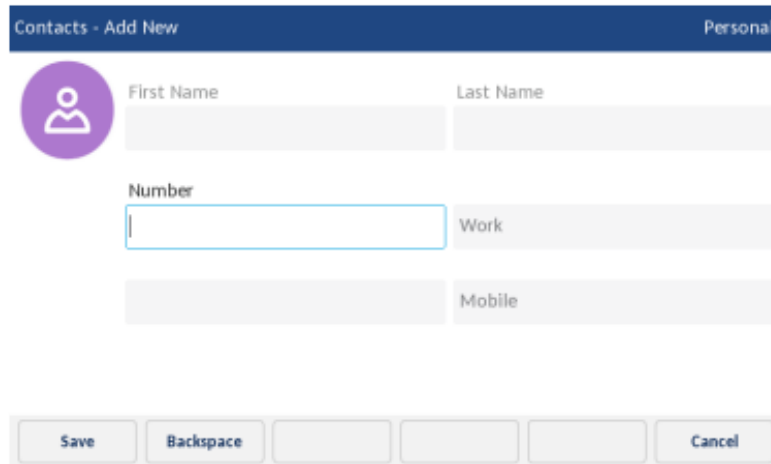

The screenshot shows the 'Contacts - Add New' screen in the 'Personal' folder. It features a purple contact icon on the left. The form includes input fields for 'First Name', 'Last Name', 'Number', 'Work', and 'Mobile'. At the bottom, there is a bar with 'Save', 'Backspace', and 'Cancel' buttons.

3. Tap the **First Name** input field and enter the first name of the personal contact using the on-screen keyboard.

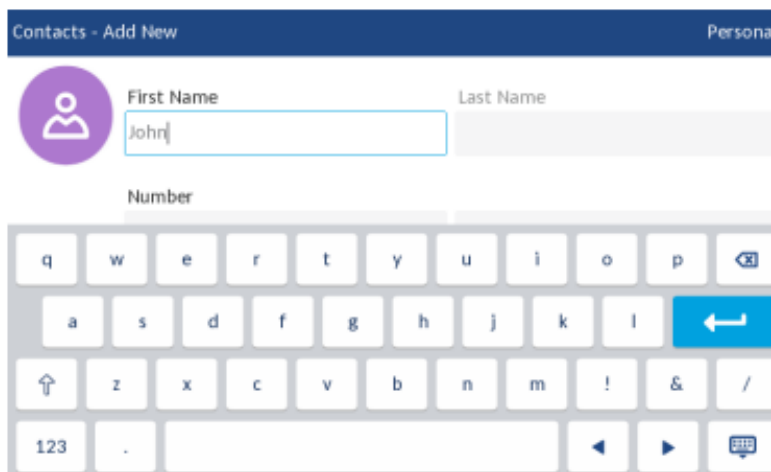

The screenshot shows the 'Contacts - Add New' screen with the on-screen keyboard open. The 'First Name' field contains the text 'John'. The keyboard is a standard QWERTY layout with a blue backspace key.

4. (Optional) Tap the **Last Name** input field and enter the last name of the personal contact using the on-screen keyboard.
5. Tap the initial **Number** input field and enter the number of the personal contact using the dialpad keys.

6. Tap the number type (Work/Home/Mobile) field and tap the left and right arrow buttons to switch the type of number (either Work, Home, or Mobile).

7. (Optional) Repeat steps 5 and 6 to enter a secondary number.
8. Tap the **Save** softkey to save the contact to your **Personal** folder.

Editing an existing contact in your Personal folder

To edit an existing contact in your **Personal** folder:

1. Press the  (**Contacts**) key.
2. (Optional) Tap the search bar, enter the first letters of the contact's name, and tap the blue return button to initialize the search function.
3. Tap contact you want to edit.

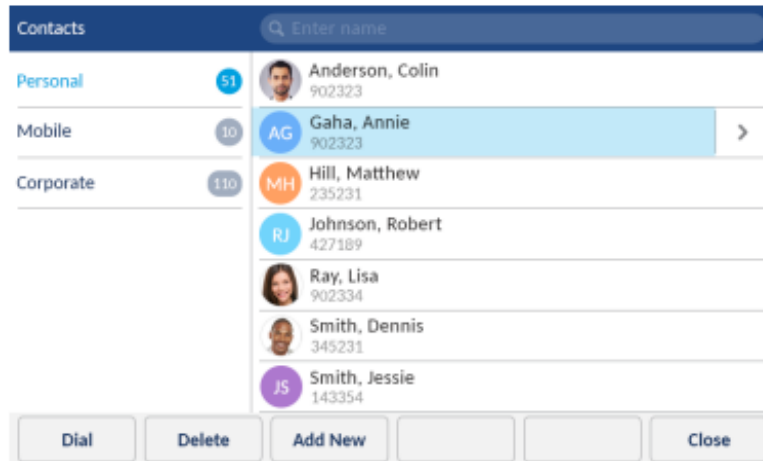

4. Press the right arrow button to view the contact card for the selected contact and tap the **Edit** softkey.

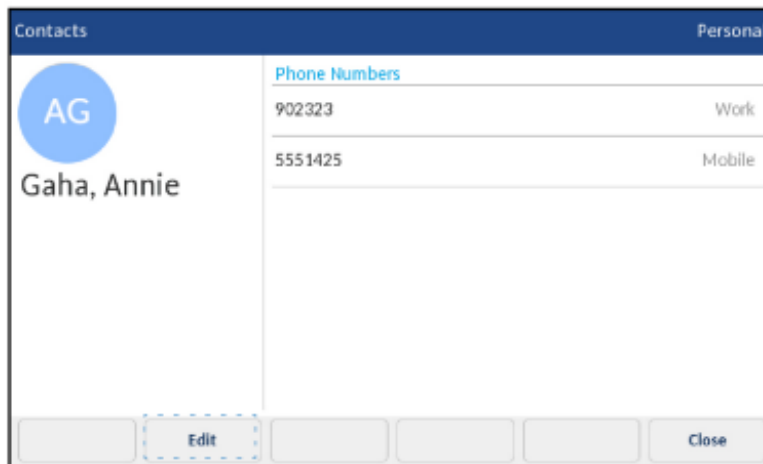

5. Tap to select the information you want change and edit using the on-screen keyboard and dialpad keys.
6. Tap the **Save** softkey to save your changes.

Deleting all contacts from the Personal folder

1. Press the  (**Contacts**) key.
2. Tap the **Delete** softkey.

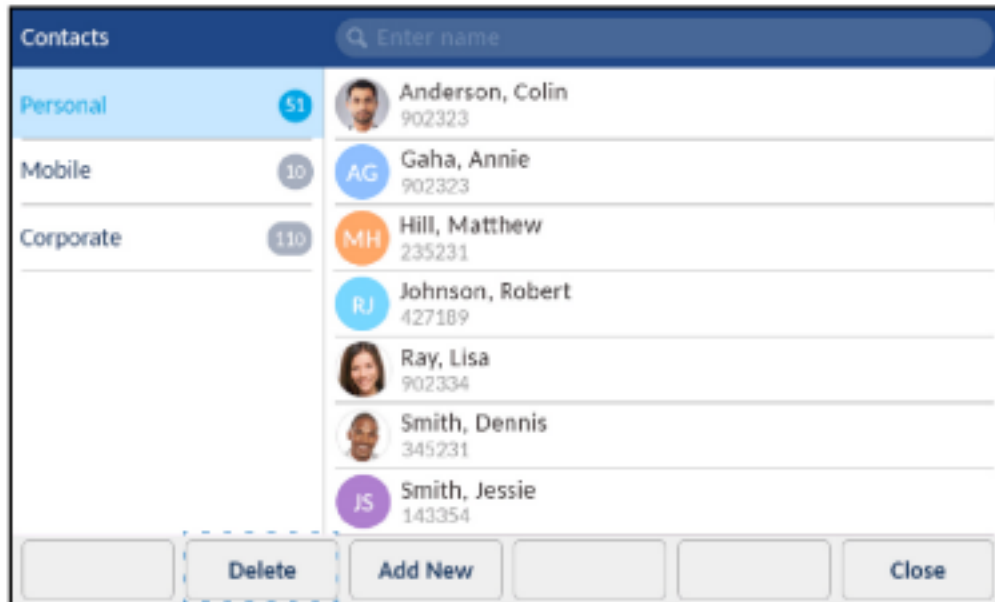

A delete all confirmation message appears on screen.

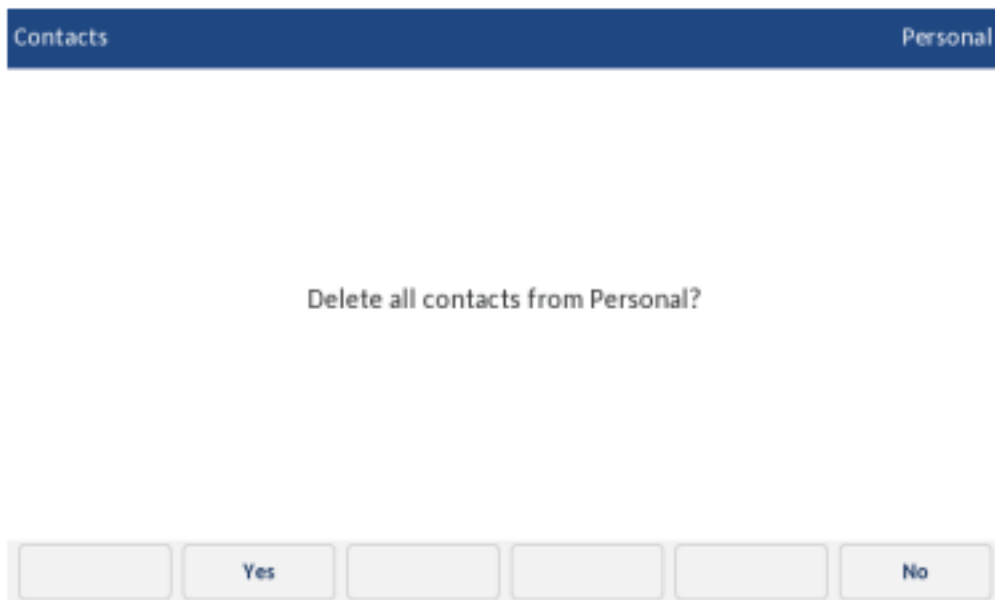

3. Tap the **Yes** softkey to delete all contacts from your **Personal** folder.

NOTE: Tap the **No** softkey to cancel the delete process.

Deleting a contact from the Personal folder

To delete contacts from your **Personal** folder:

1. Press the  (**Contacts**) key.
2. (Optional) Tap the search bar, enter the first letters of the contact's name, and tap the blue return button to initialize the search function.
3. Tap to select the applicable contact and tap the **Delete** softkey.

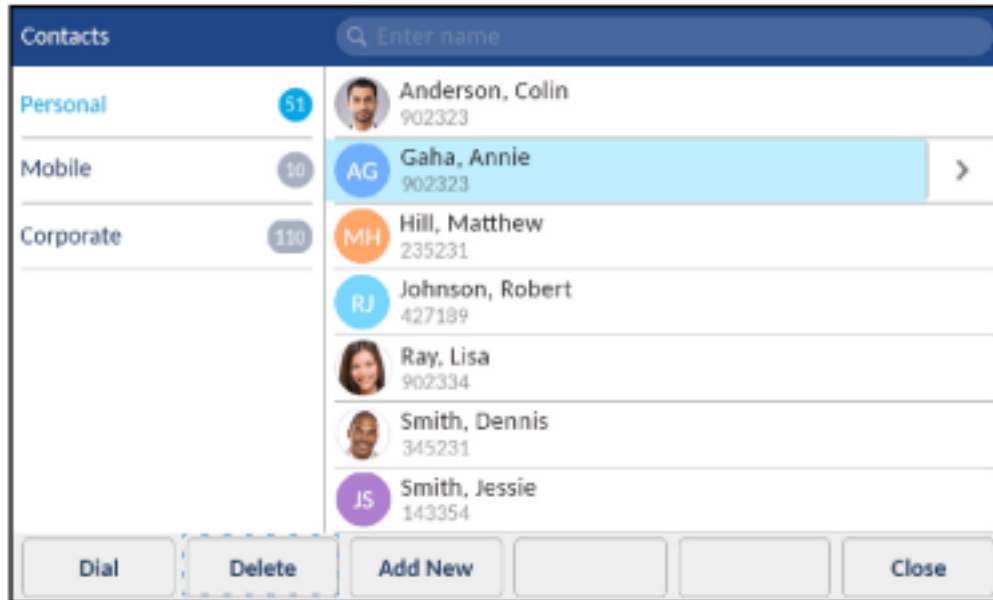

A delete confirmation message appears on screen.

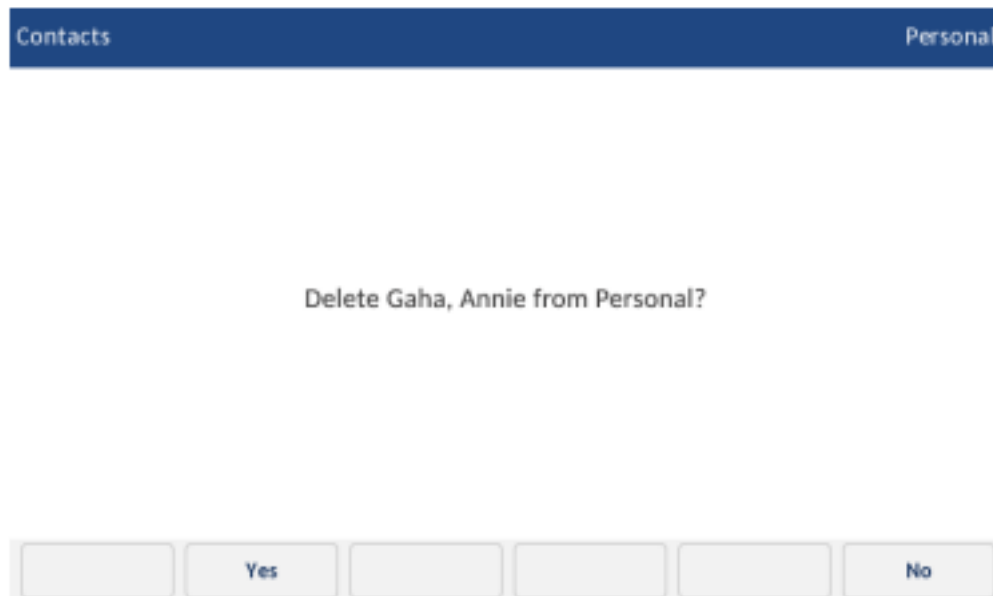

4. Tap the **Yes** softkey to delete the selected contact from your **Personal** folder.

NOTE: Tap the **No** softkey to cancel the delete process.

Corporate and Mobile folder features

The **Corporate** folder contains the contacts that are available through your corporate LDAP directory. The **Mobile** folder contains your mobile phone contacts (if synchronized).

NOTE:

1. Access to corporate directories must be set up by your System Administrator.
2. Updates made to your corporate directory are reflected on your phone only at the re-synchronization time configured on the MiVoice Business phone system.
3. For more information on syncing mobile contacts and MobileLink functionality, see [“Syncing mobile contacts”](#).

There are two types of corporate directories that can be configured:

1. **Cached:**

Contacts are cached on the phone and are viewable as a list in the **Corporate** contact folder upon entering the Contacts application. You can scroll up and down to view your list of corporate contacts. Performing a basic search applies to both the **Personal** and **Corporate** contacts folders.

2. **Non-cached:**

Contacts are not cached on the phone and therefore contacts are not available until you perform a lookup in the **Corporate** contact folder. Used for corporate directories with a large amount of contacts as caching a large amount of contacts could, at times, overload the IP phone.

You can perform all the same functions as the **Personal** folder from the **Corporate** and **Mobile** folders except for adding, deleting, and editing entries. In addition to being able to search for a corporate or mobile contact, place a call to the selected corporate or mobile contact, and view corporate or mobile contact's contact card, you can copy the corporate or mobile contact to your **Personal** folder.

If a call is placed from the **Corporate** folder matches with a contact stored in the **Personal** or **Mobile** folder in the **Contacts** application, then the contact name is displayed. The contact name look up is in the following order:

1. Personal Contacts, where respective Personal Contacts name is displayed.
2. Mobile Contacts, where respective Mobile Contacts name is displayed.
3. MiVoice Business System Contacts, where if the MiVoice Business System is configured with MiNET Phone Object Message Name, then the respective MiVoice Business System name is displayed.

If there is no match, then the number returned by the MiVoice Business system is displayed.

NOTE: See [“Performing a search”](#) for details on how to perform a search on your cached Corporate contact folder as well as your Mobile contact folder.

Performing a search on a non-cached Corporate contact folder

To perform a search on a non-cached **Corporate** contact folder:

1. Press the  (**Contacts**) key.

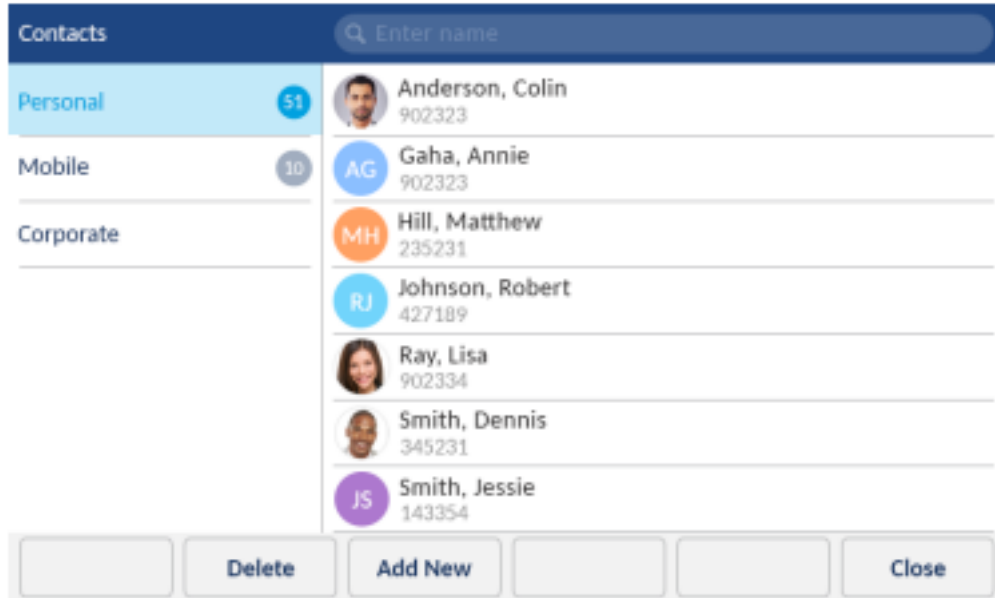

2. Tap the **Corporate** folder.

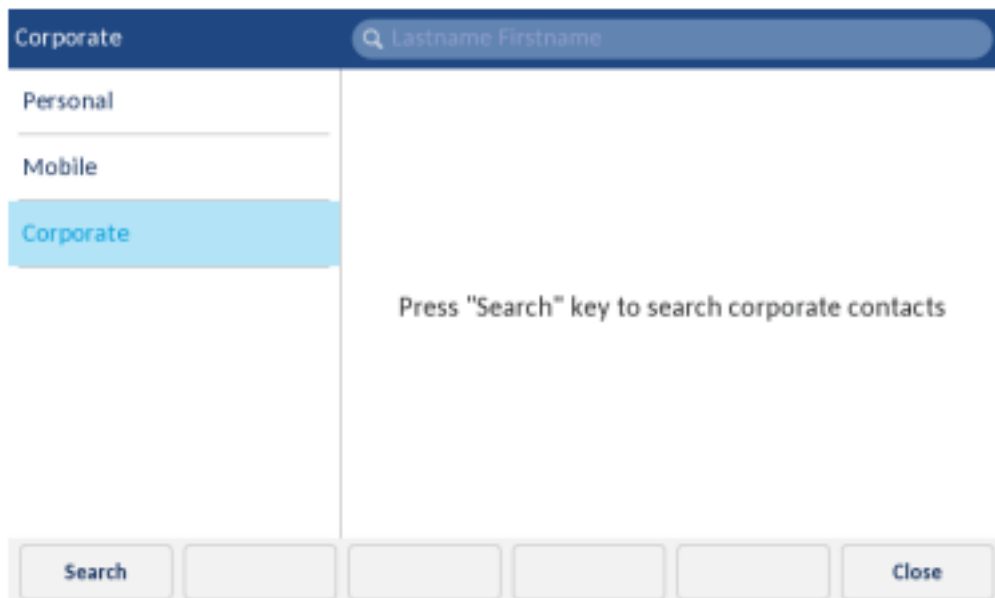

3. Tap the **Search** softkey or search bar.

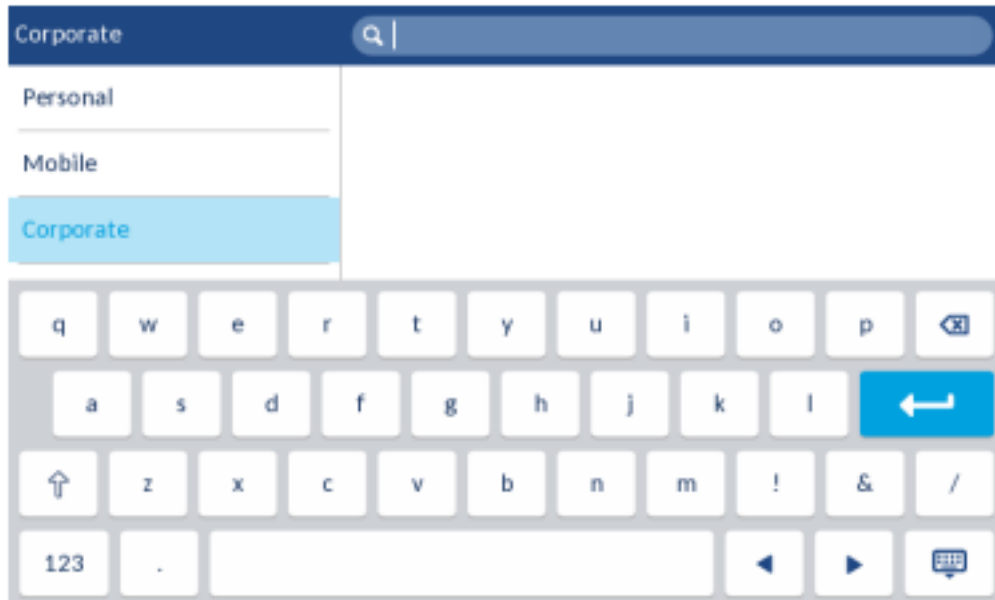

- Using the on-screen keyboard, enter all or the first few letters of the contact's last name in the search field. Alternately, you can enter all or the first few letters of the contact's last name followed by a space and all or the first few letters of the contact's first name and tap the blue return key.

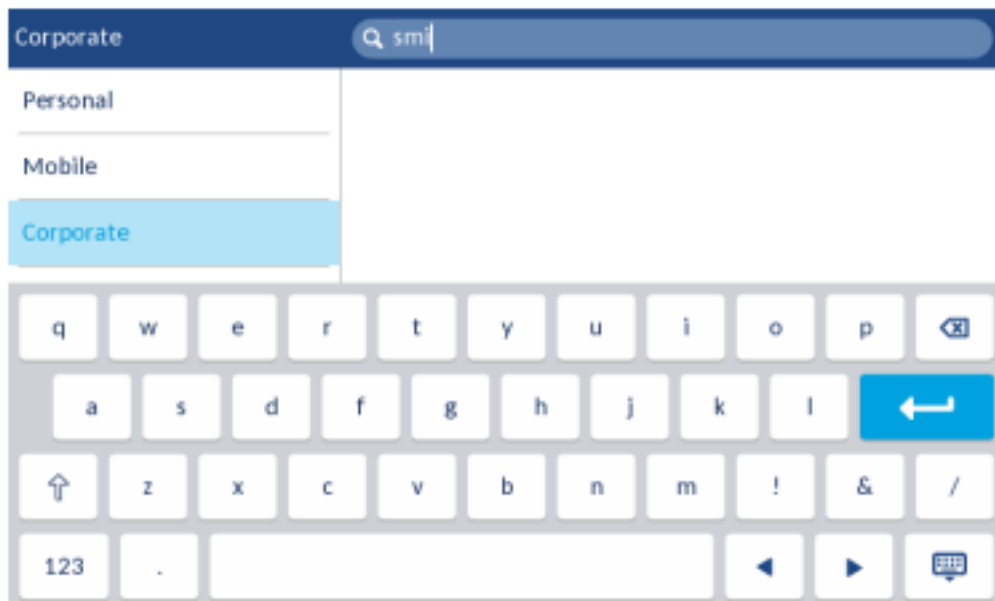

- NOTE:** For non-cached corporate directories, searches are based on the last name of the contact.
- If matches are found, tap the applicable contact entry and perform your desired action.

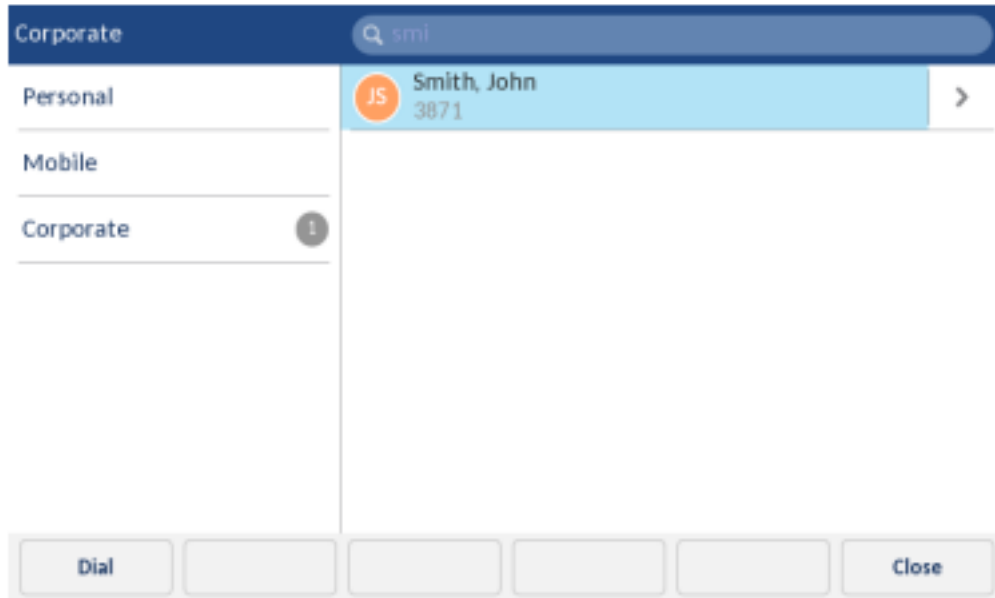

Copying a Corporate or Mobile contact to the Personal folder

To copy a contact in your **Corporate** or **Mobile** folder to your **Personal** folder:

1. Press the  (**Contacts**) key.
2. If applicable, for non-cached corporate directories, perform a search as detailed in [“Performing a search on a non-cached Corporate contact folder”](#)
or
(Optional) For cached corporate directories, tap the search bar, enter the first letters of the contact’s name, and tap the blue return button to initialize the search function.
3. Tap to select the corporate or mobile contact you want to copy to your **Personal** folder.

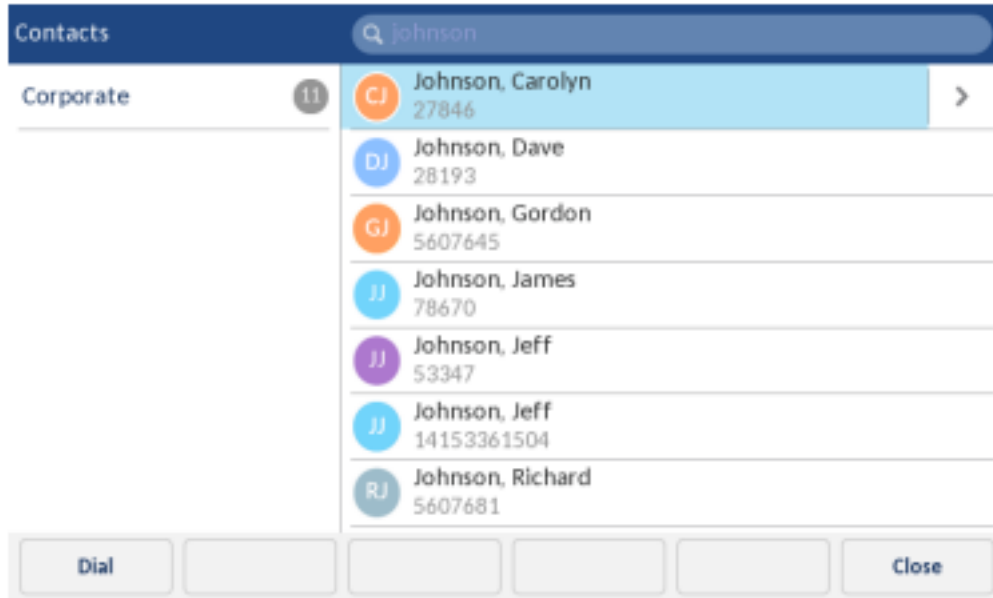

4. Tap the right arrow button to view the corporate or mobile contact's contact card.

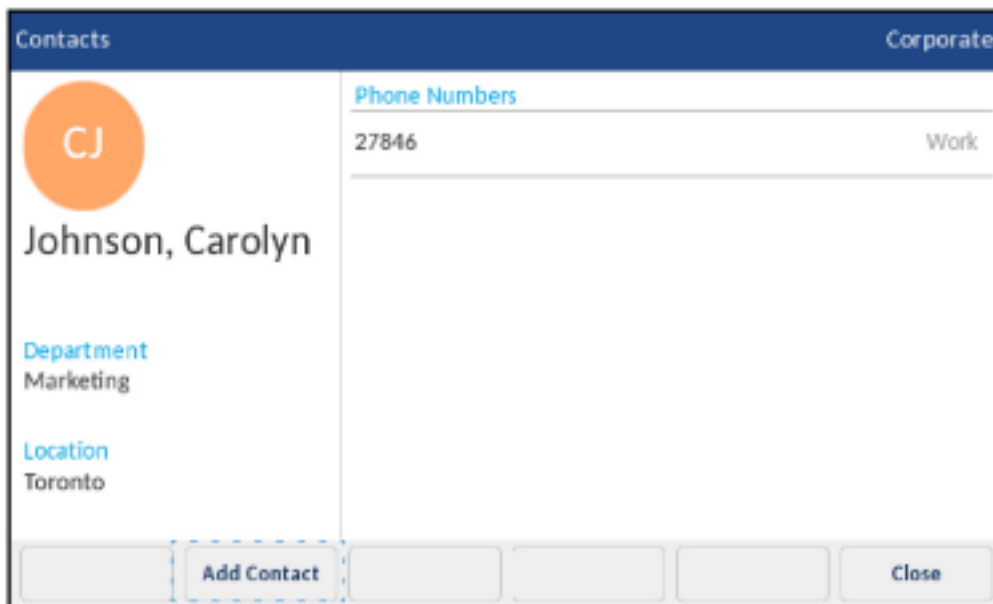

5. Tap the **Add Contact** softkey.
A copy confirmation message is displayed.

Call History

The **Call History** application is a stored log of all your calls. You can view details of all your outgoing and received calls as well as any calls that were unanswered or missed. Your telephone logs the type of call, information regarding the remote party (name, number, and avatar), and the time of the call.

You can view and delete entries in the **Call History** as well as copy selected entries to the your **Personal** folder in the **Contacts** application. You can also dial an entry directly from the **Call History** application.

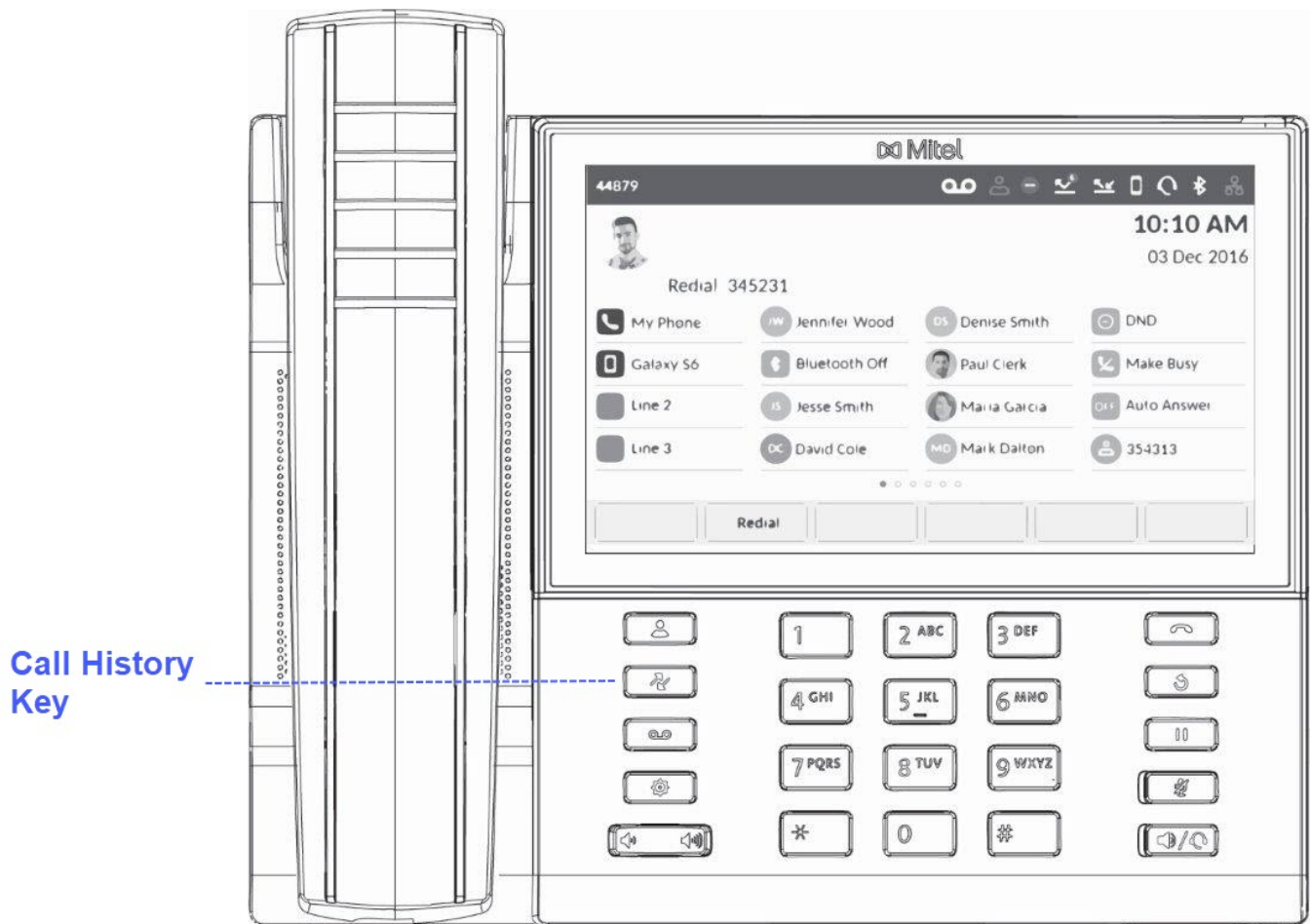

NOTE: For more information on syncing mobile call history and MobileLink functionality, see [“Syncing mobile call history”](#).

The following table identifies and describes the various icons displayed in the **Call History** application:

Icon	Description
	Indicates an incoming call that was not answered (missed).
	Indicates an outgoing call (outgoing)

	Indicates an incoming call that was answered (received).
---	--

To access and use the **Call History** application:

1. Press the  (**Call History**) key.





2. Type the call type (**My Phone**, **Missed**, **Outgoing**, and **Received**) to view the respective list of call entries.
3. Swipe up and down to scroll through the call entries.
4. Tap to select a call entry.



- Press the right arrow button beside the selected call entry to display the individual call details.

NOTE: The call details screen contains the avatar of the caller (if available), the date and time of the call, and the caller ID details.

- Tap the **Dial** softkey or press the  (**Speaker/Headset**) key for speaker or headset operation
or
Pickup the handset for handset operation.
- Press the  (**Goodbye**) key or tap the **Close** softkey to exit.

Deleting entries from the Call History application

You can delete all entries in the **Call History** application regardless of call type, all entries within a call type folder, or individual entries.

To delete all entries from the **Call History** application:

- Press the  (**Call History**) key.
- Tap the **My Phone** call type folder.

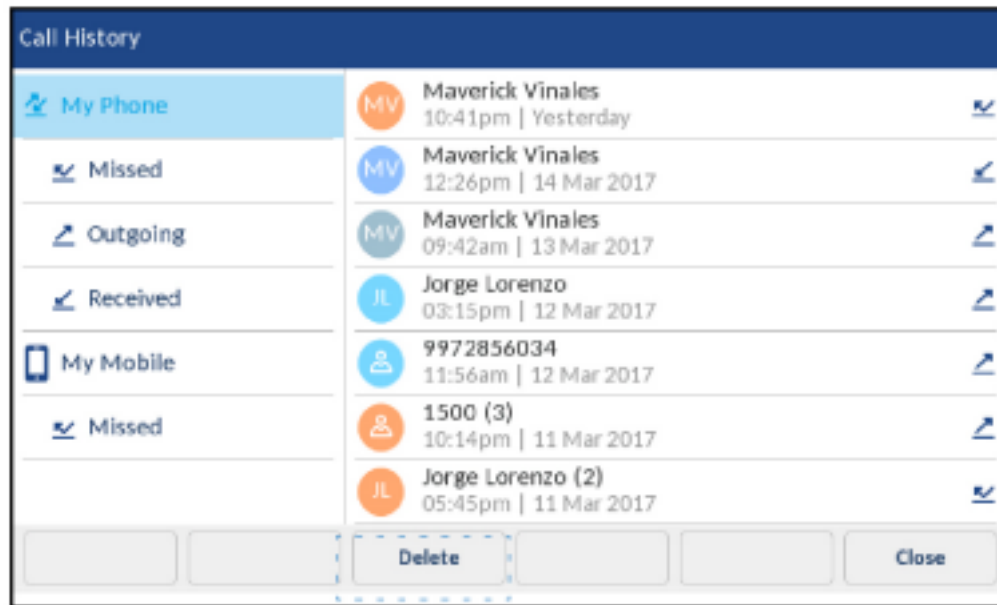

3. Tap the **Delete** softkey.

A delete all confirmation message appears on screen.

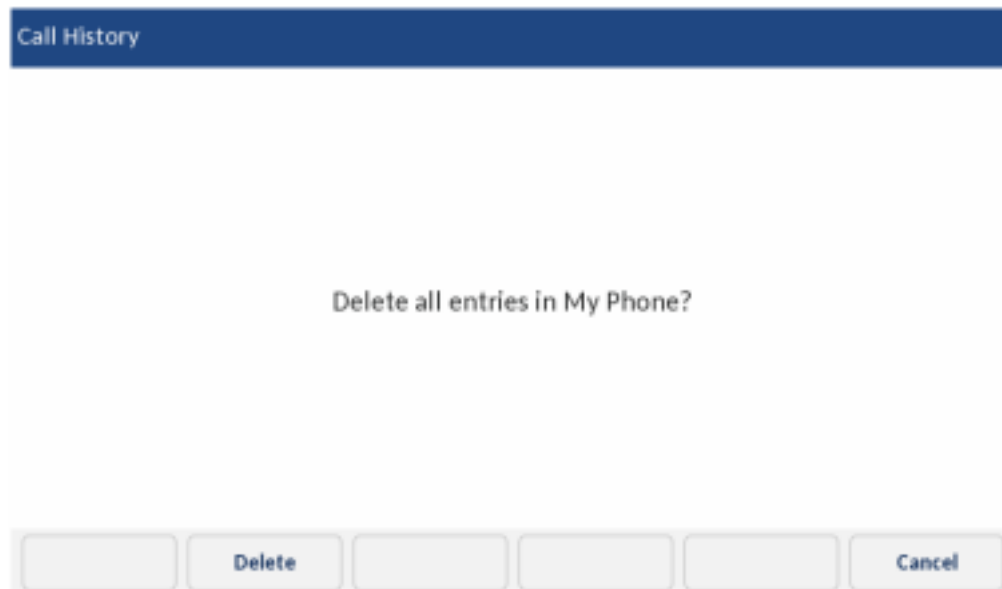

4. Tap the **Delete** softkey again to delete all entries in the **Call History** application.

NOTE: Tap the **Cancel** softkey to cancel the delete process.

To delete all entries from a call type folder:

1. Press the  (**Call History**) key.
2. Tap the applicable call type folder you wish to delete.

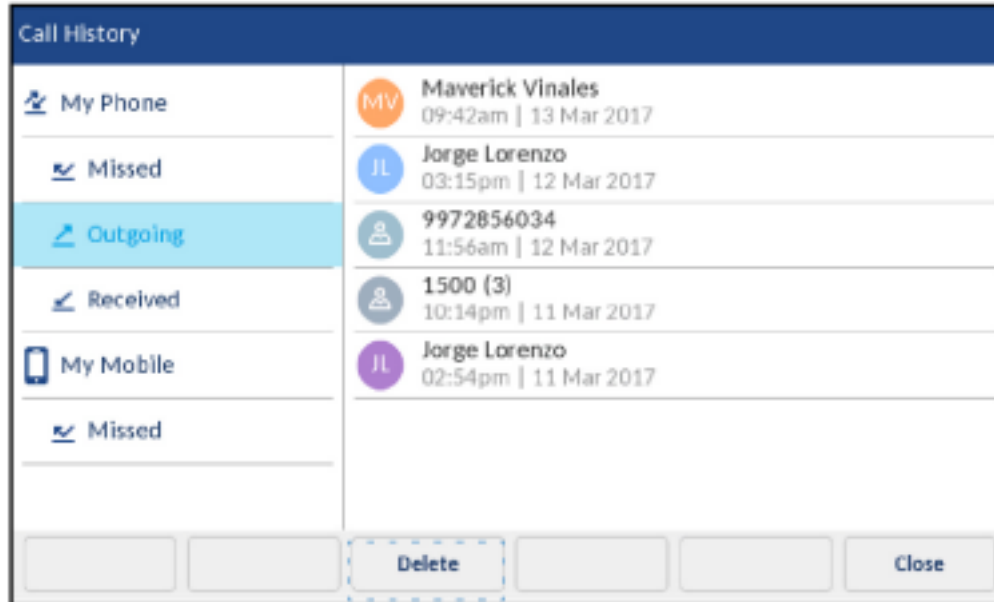

3. Tap the **Delete** softkey.

A delete all confirmation message appears on screen.

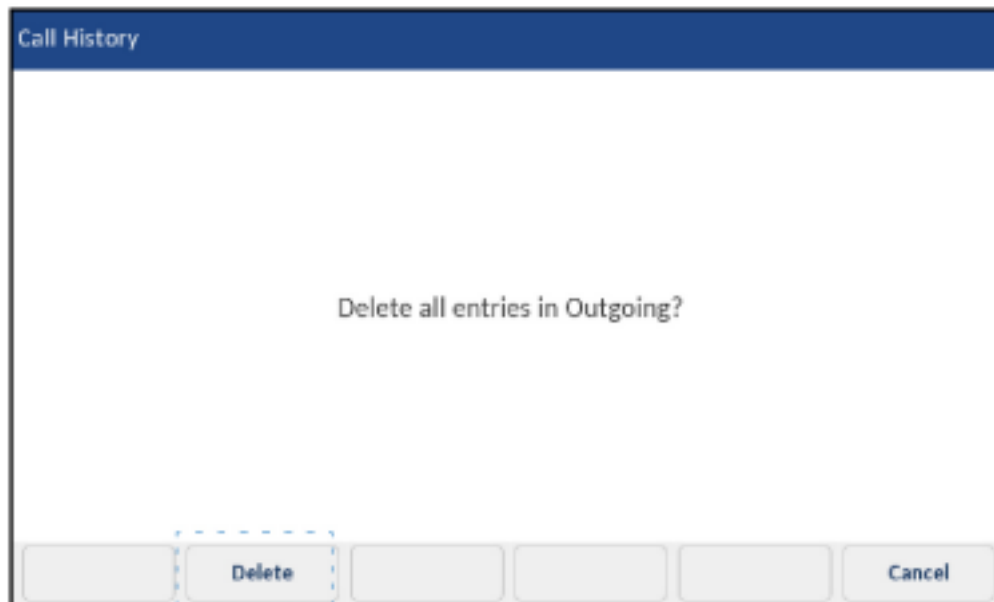

4. Tap the **Delete** softkey again to delete all entries in the selected call type folder.

NOTE: Tap the **Cancel** softkey to cancel the delete process.

To delete individual entries from a call type folder:

1. Press the  (**Call History**) key.
2. Tap the applicable call type folder.
3. Tap to select the individual call entry.

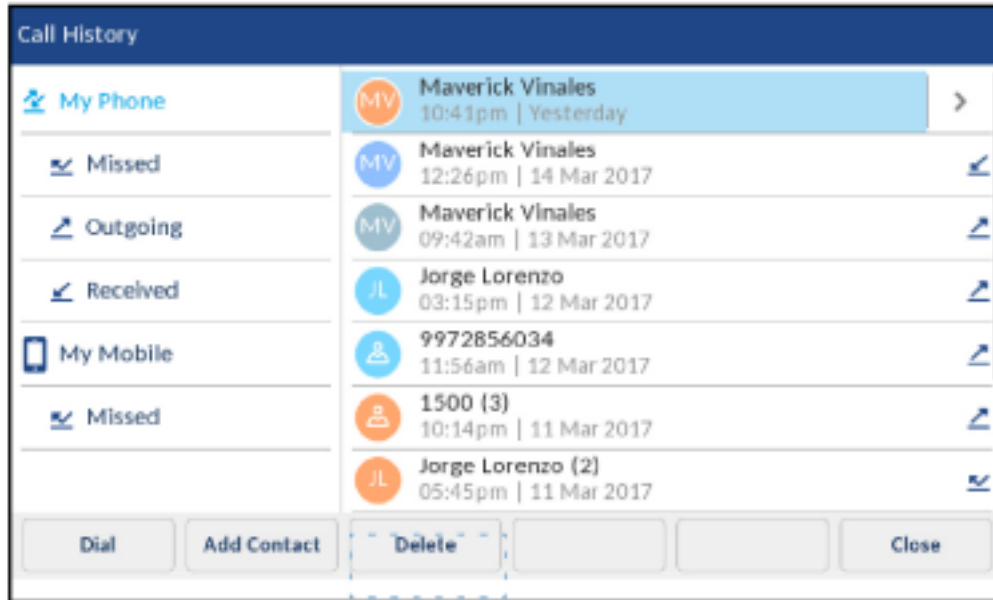

4. Tap the **Delete** softkey.

A delete confirmation message appears on screen.

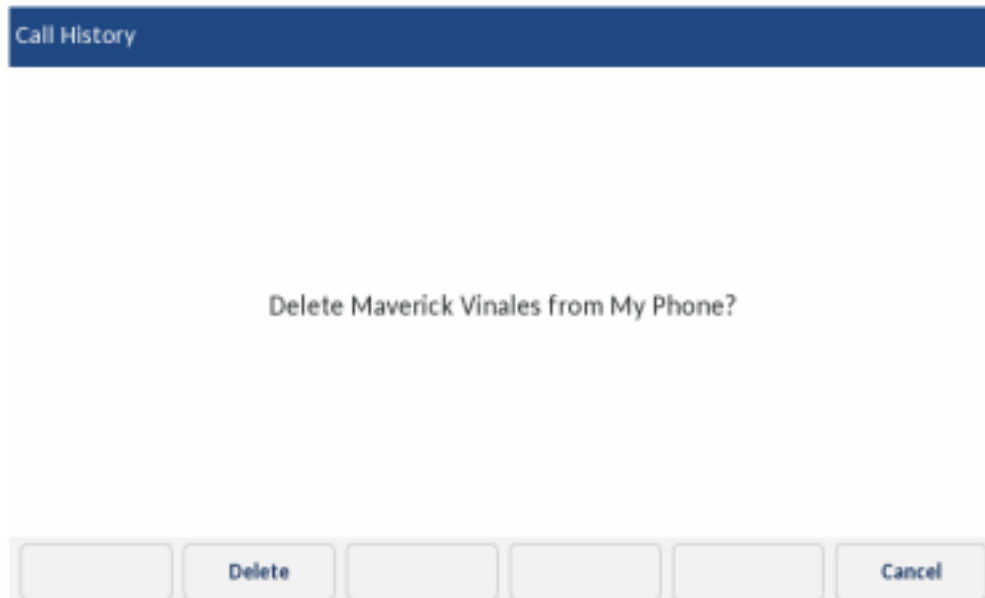

5. Tap the **Delete** softkey again to delete the individual call entry.

NOTE: Tap the **Cancel** softkey to cancel the delete process.

Copying entries to the Personal folder in the Contacts application

To copy a Call History entry to the **Personal** folder in the **Contacts** application:

1. Press the  (**Call History**) key.
2. Tap the applicable call type folder.
3. Tap to select the call entry you want to copy to your **Personal** folder in your **Contacts** application.



4. Tap the **Add Contact** softkey.
A copy confirmation message is displayed.

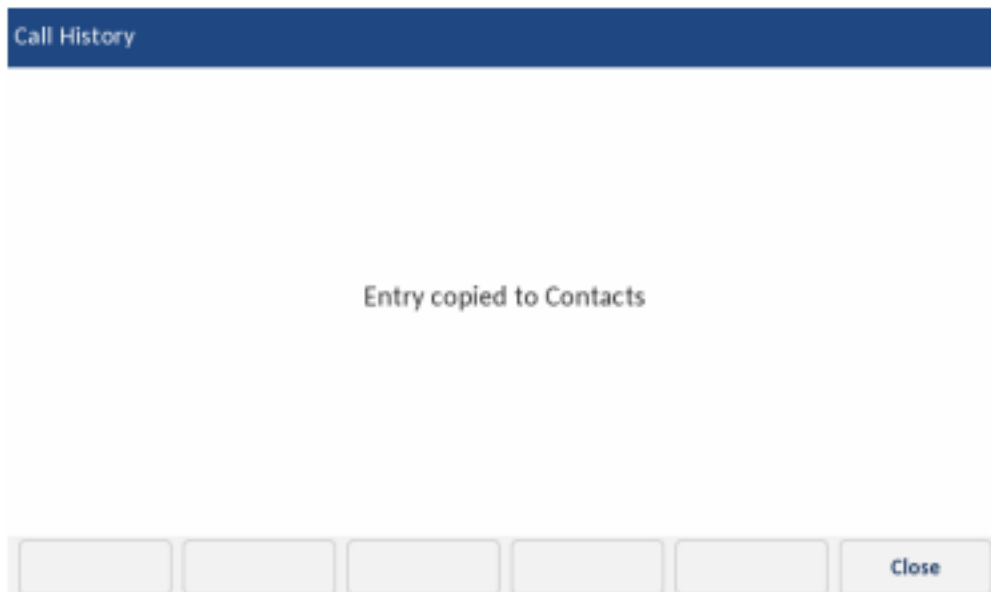

Missed calls indicator

The Mitel MiVoice 6940 IP phone has a missed calls icon located on the status bar that indicates the number of calls that went unanswered.

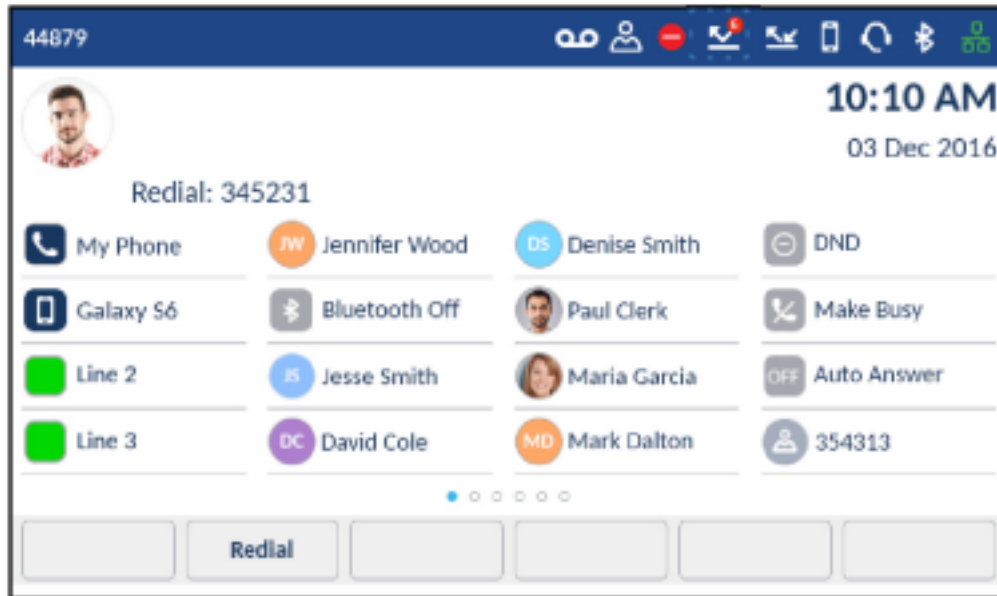



As the number of unanswered calls increment, the information associated with the calls are stored in the **Call History** application under the **Missed** call folder. When the user accesses the **Missed** call folder, the missed call indicator on the **Home** screen is removed.

NOTE: Missed calls are also indicated on the screensaver.

To view missed call details in Call History application:

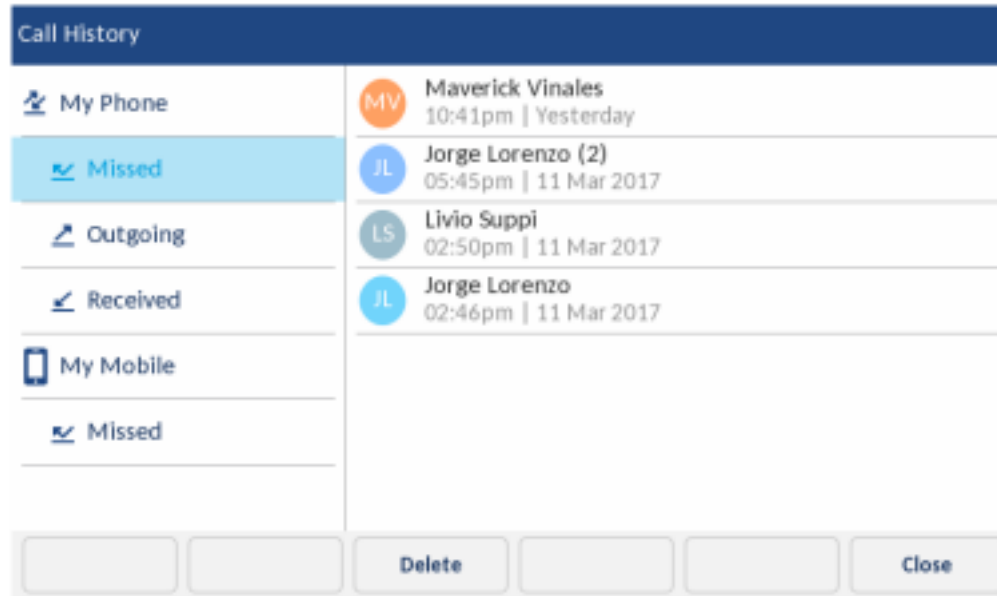
1. Press the  (**Call History**) key.
2. Tap the **Missed** call type folder.



3. Tap the individual call entry.
4. Tap the right arrow button to see more detailed information about the call entry.
5. Press the  (**Goodbye**) key or tap the **Close** softkey to exit.

The missed calls indicator on the **Home** screen is cleared upon exit.

Voicemail

NOTE: Voicemail functionality must be configured by your System Administrator.

When voicemail functionality is enabled, the MWI LED on the Mitel MiVoice 6940 flashes red and

the  (**Voicemail**) icon displays on the status bar indicating that voicemail messages are available. You can access your voicemail service by pressing the **Voicemail** key.

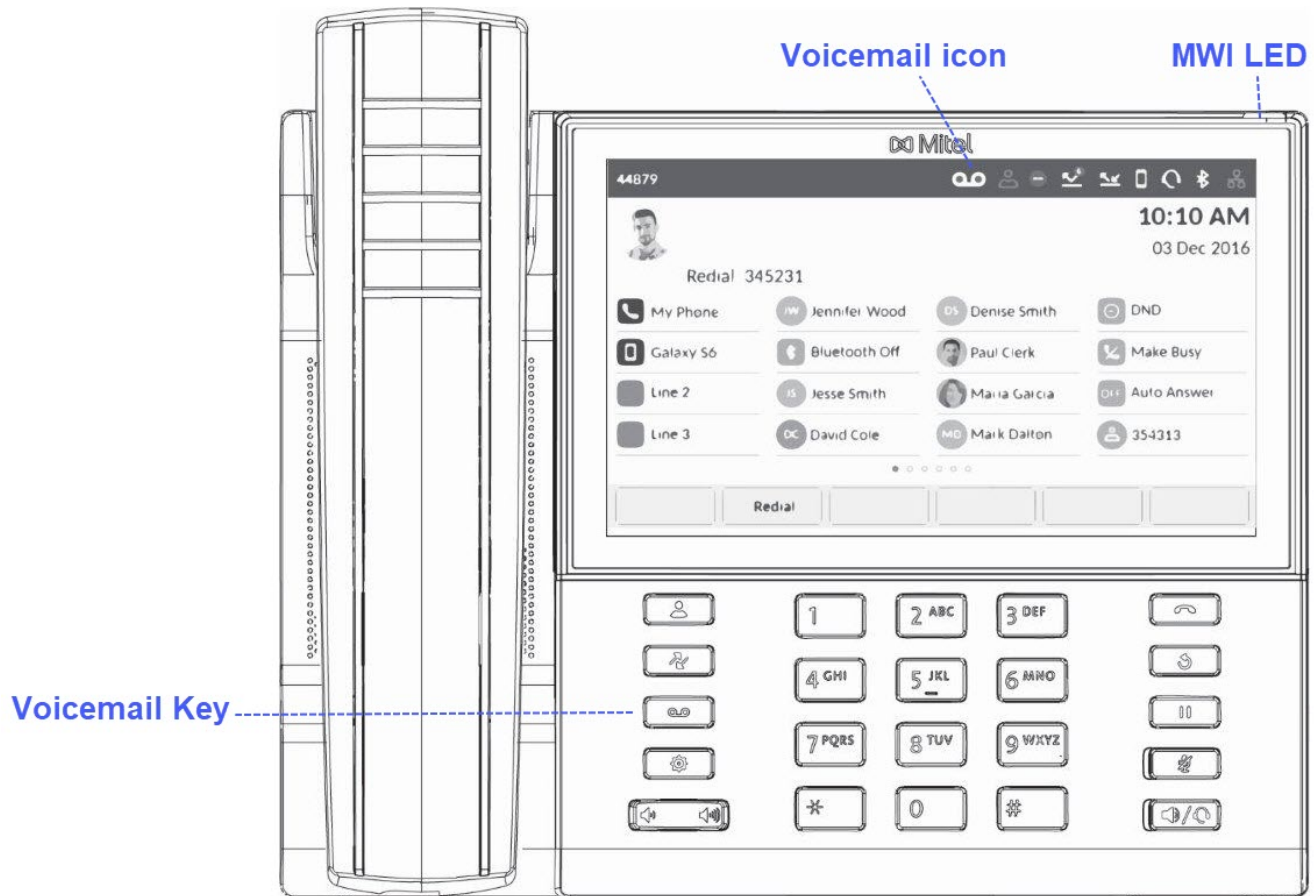

To access your voicemail:

1. Press the  (**Voicemail**) key.

NOTE:

- a. If the handset is offhook or if the phone is in speakerphone or headset mode, pressing the  (**Voicemail**) key will call your message center directly.
- b. The call to your message center is placed regardless of whether or not a message is pending.

2. (Optional) If your phone is idle, tap the **More** softkey to view the date and time of the last voicemail message received.

NOTE: Tapping the **Erase** key clears the current message indicators on the phone (i.e. MWI LED and last voicemail message received history). It does not delete the messages contained in your voicemail account.

3. If your phone is idle, tap the **Call** softkey.
4. When you are connected to your message center, follow the audio prompts to perform any applicable actions.

NOTE: For more detailed information on voicemail features and functionality, see the *Mitel MiVoice Business Voice Mail User Guide*.

Visual voicemail

NOTE: Visual voicemail functionality must be configured by your System Administrator.

Visual voicemail allows you to visually interact with your voicemail. Visual voicemail displays an accurate count of your voicemail messages on the status bar and the screen saver. The count on the screen saver is a total of missed calls and voicemail messages.

NOTE:

1. If you have subscribed to Embedded Voicemail (EMEM), missed voicemail count is displayed only if the EMEM and the 6900 Series IP Phones are programmed on the same MiVoice Business System.
2. If you have subscribed to NuPoint voicemail, the message count is not supported.

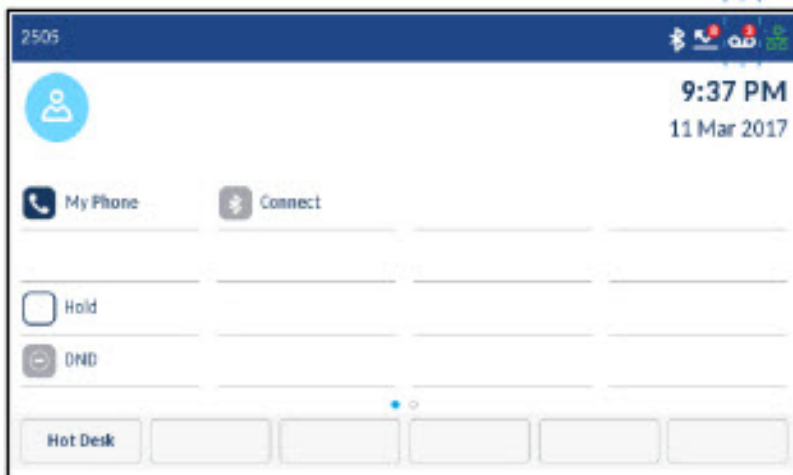

Voicemail count on status bar

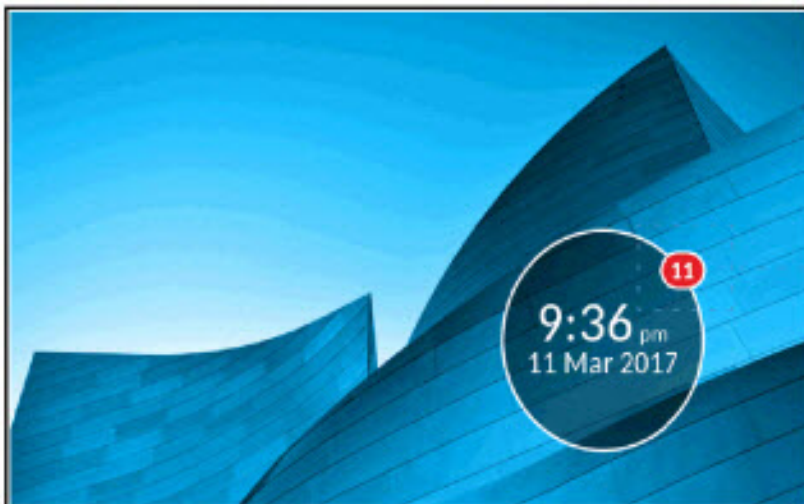

Voicemail and missed call count on screen saver

Visual voicemail by default, selects **New** and displays new voicemail messages in Bold font. Urgent voicemail messages are indicated by a Red exclamation point.

Enabling voicemail application

To enable voicemail application:

1. Press the  (**Settings**) key on the phone to enter the **Settings** menu.

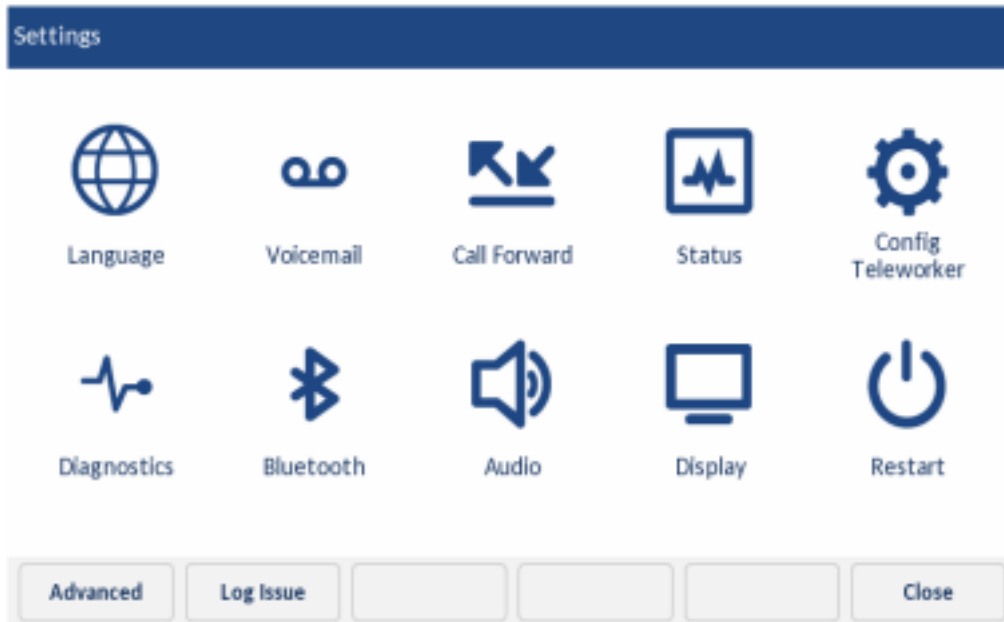

2. Tap **Voicemail**.
3. Tap the **key opens Voicemail App** checkbox to select the checkbox.

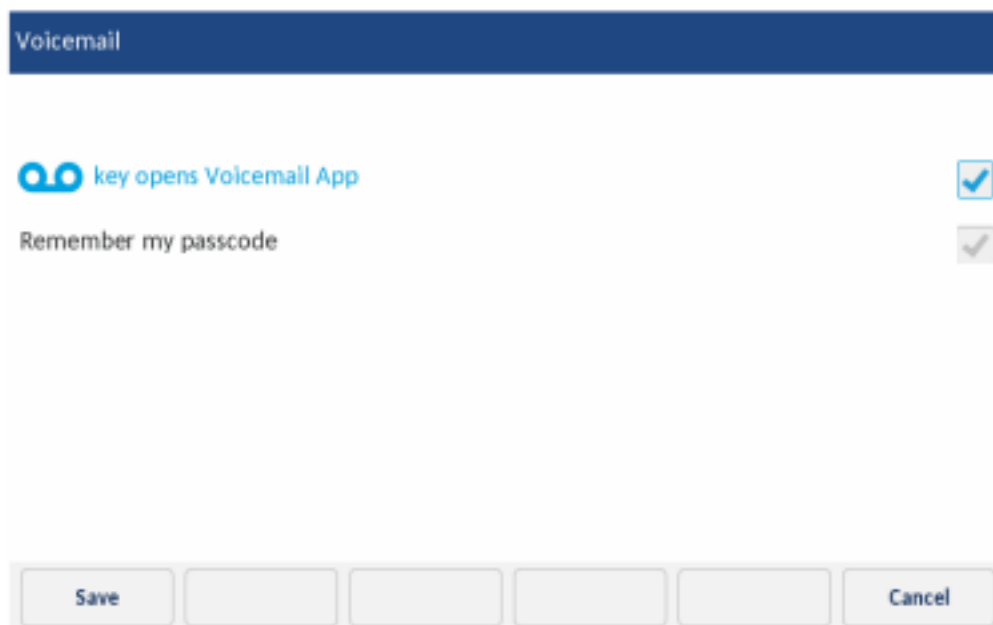

4. Tap **Save**.

NOTE: For security reasons, the password can be enabled only from the user login screen.

Logging into your voicemail

To log into your voicemail:

1. Press the  (**Voicemail**) key.
2. Tap the **Passcode** field and enter the passcode.

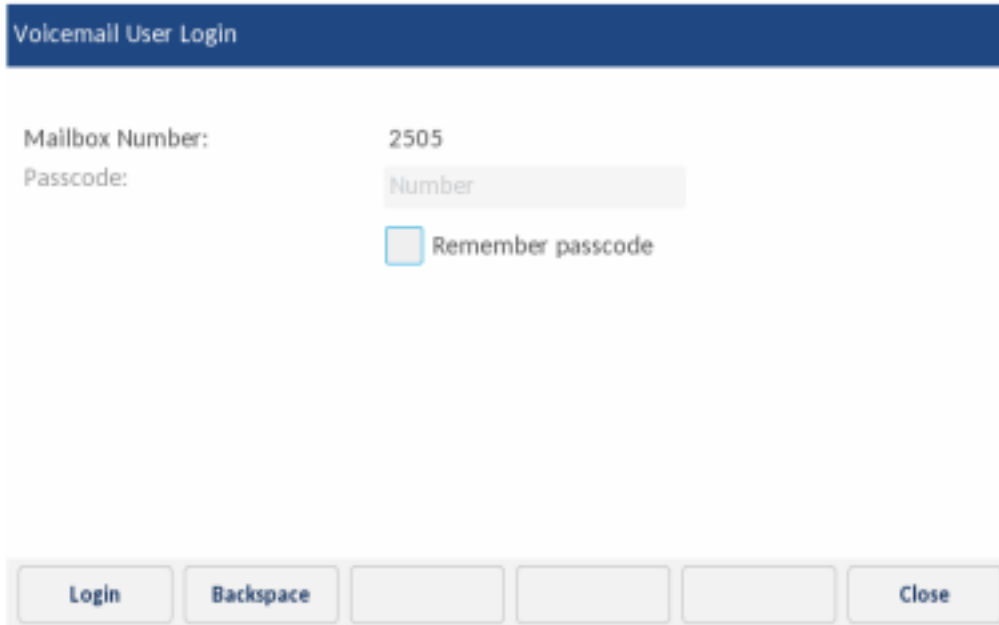

Voicemail User Login

Mailbox Number: 2505

Passcode: Number

Remember passcode

Login Backspace Close

3. (Optional) Tap the **Remember passcode** checkbox to select the checkbox

NOTE: If **Remember passcode** checkbox is selected, the phone stores your passcode and launches your voicemail without having to enter your passcode each time you log into your voicemail.

4. Tap **Login** to log into your voicemail.

Logging out of your voicemail

To log out of your voicemail:

1. Tap **Logout**.

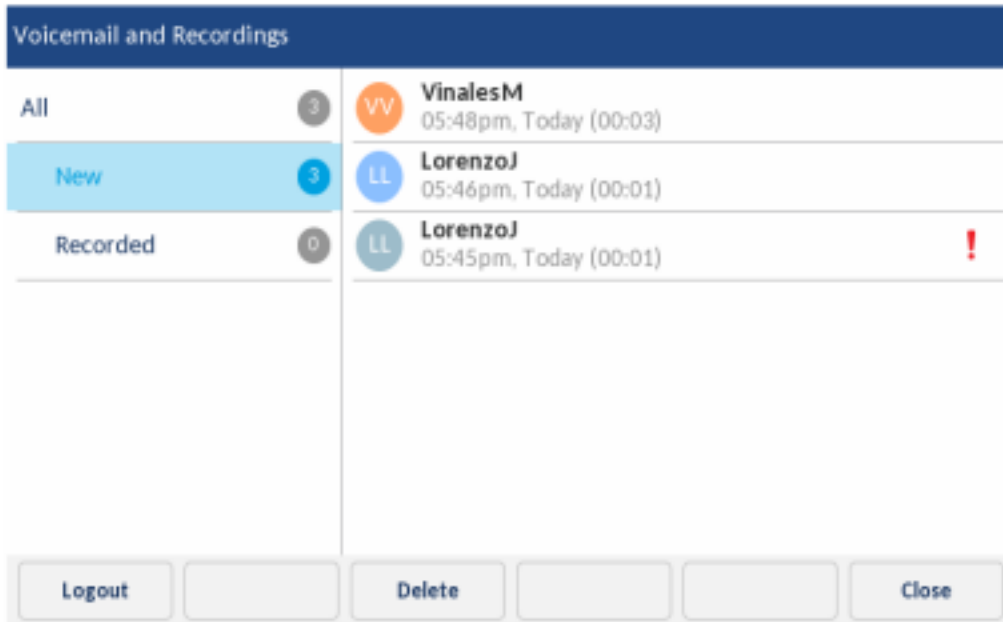

NOTE: After five minutes of inactivity, you are automatically logged out of your mailbox and the **Voicemail** application closes. When you close the **Voicemail** application, you are not automatically logged out of your mailbox.

Playing a voicemail

To play a voicemail:

1. Log into your voicemail.
2. Tap one of the following:
 - **All** - Displays all voicemail messages.
 - **New** - Displays new voicemail messages.
 - **Recorded** - Displays recorded voicemail messages.

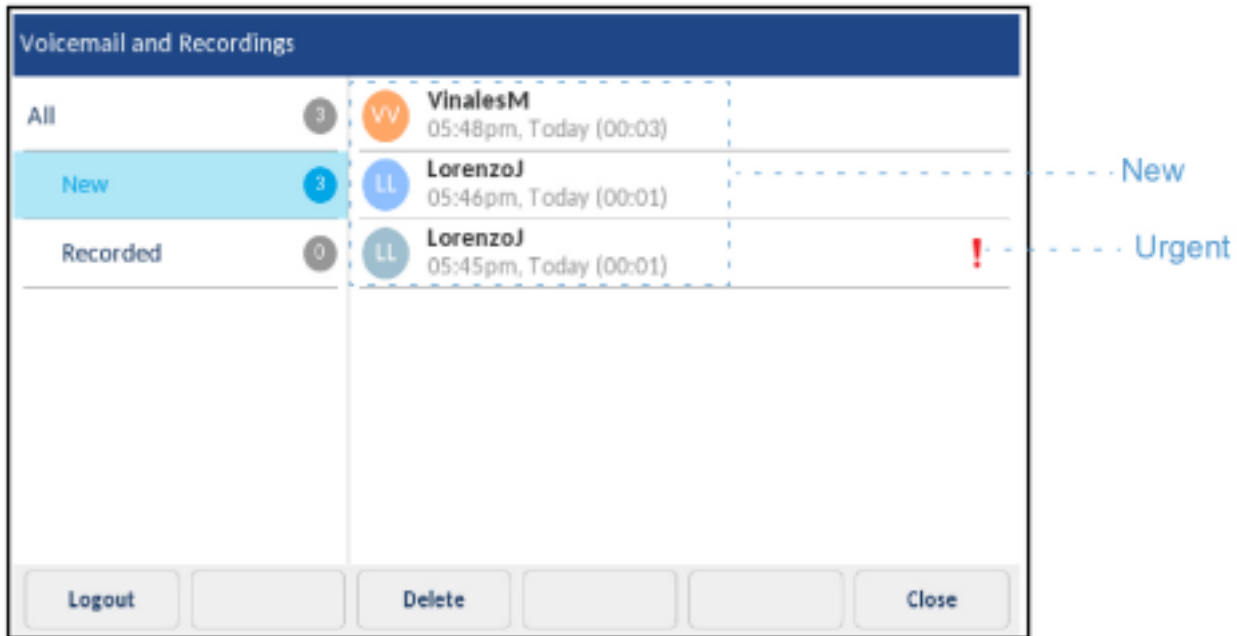

3. Tap the voicemail you want to play.

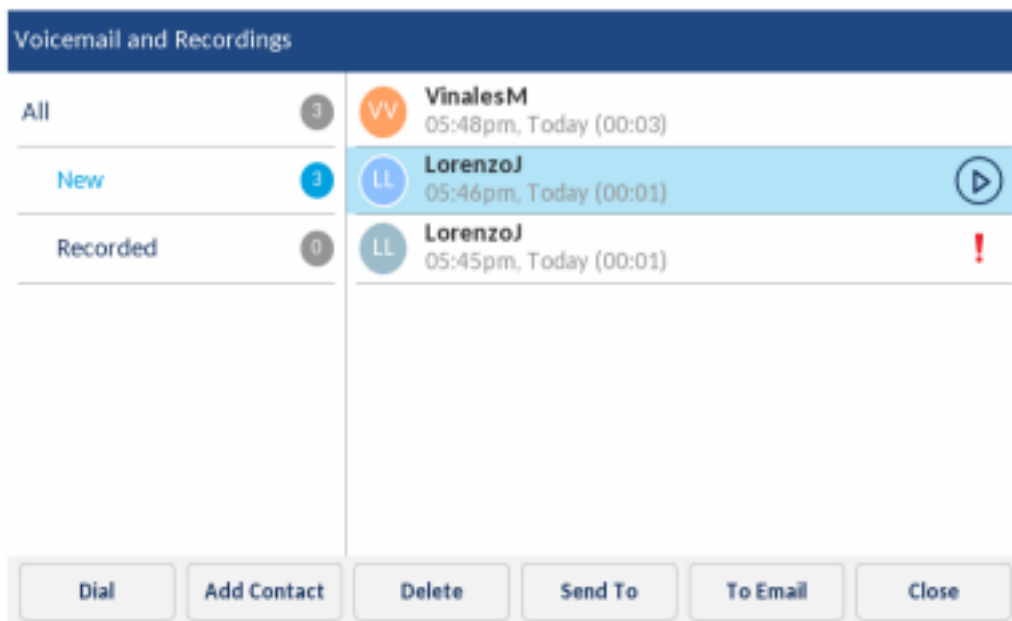

4. Tap the play icon to play the voicemail message.

Dialing a voicemail

To dial a voicemail message:

1. Log into your voicemail.
2. Tap one of the following:

- **All** - Displays all voicemail messages.
- **New** - Displays new voicemail messages.
- **Recorded** - Displays recorded voicemail messages.

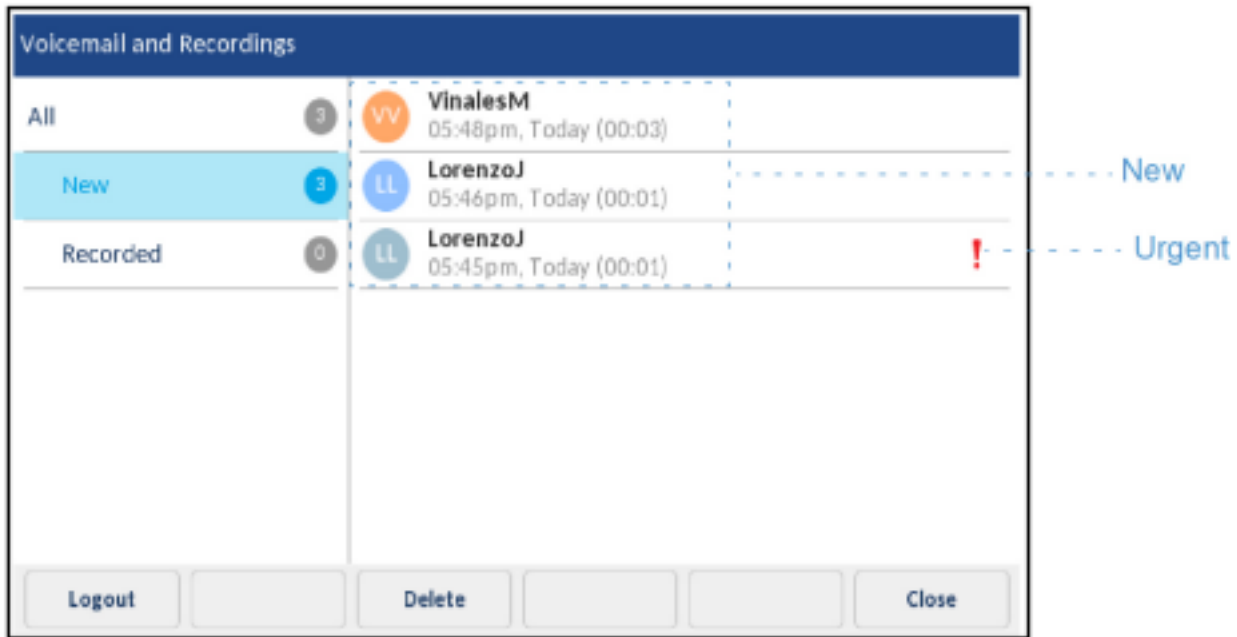

3. Tap the voicemail to you want to dial.

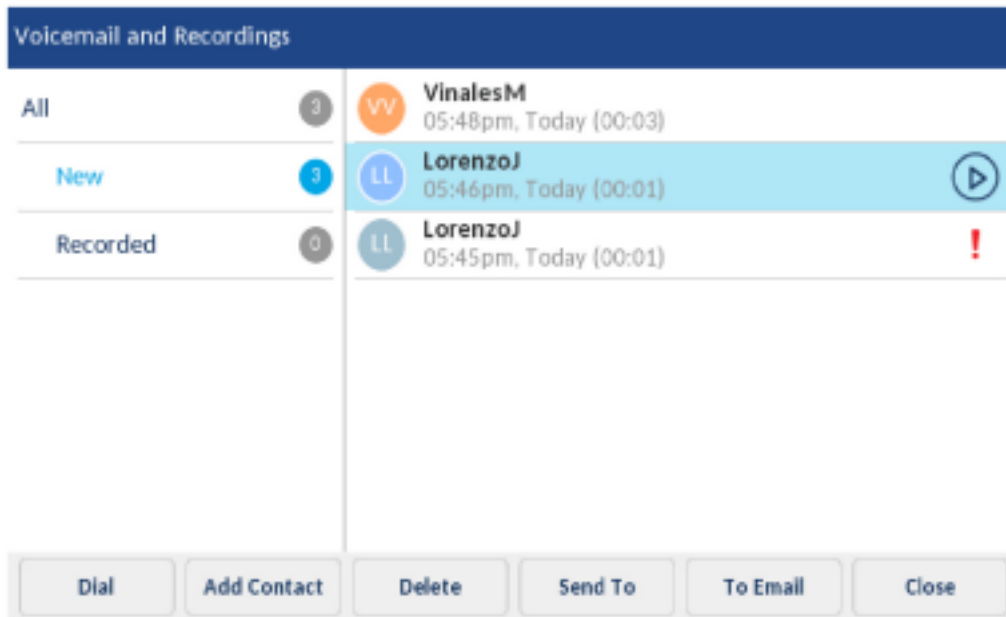

4. Tap **Dial** to dial the number.

Deleting a voicemail

To delete a voicemail:

1. Log into your voicemail.
2. Tap one of the following:
 - **All** - Displays all voicemail messages.
 - **New** - Displays new voicemail messages.
 - **Recorded** - Displays recorded voicemail messages.

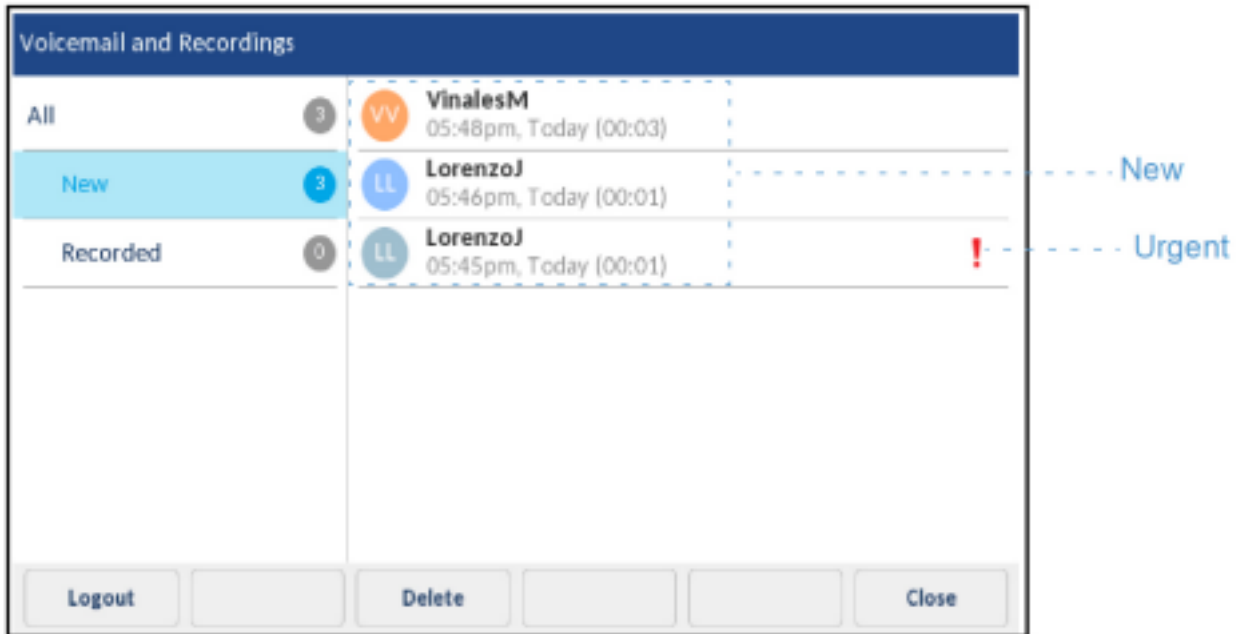

3. Tap the voicemail you want to delete.

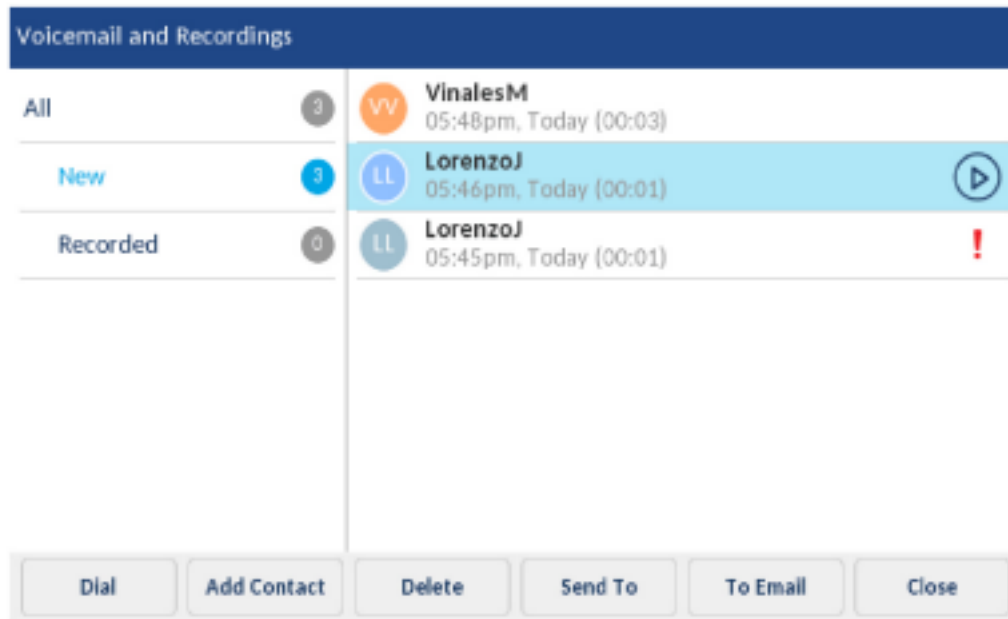

4. Tap **Delete**.

A delete confirmation message appears on screen.

5. Tap **Delete** to delete the voicemail.

Saving a voicemail

Visual voicemail automatically saves played voicemail messages in the **All** folder.

Sending voicemail to a number

To send a voicemail to a number:

1. Log into your voicemail.
2. Tap one of the following:
 - **All** - Displays all voicemail messages.
 - **New** - Displays new voicemail messages.
 - **Recorded** - Displays recorded voicemail messages.

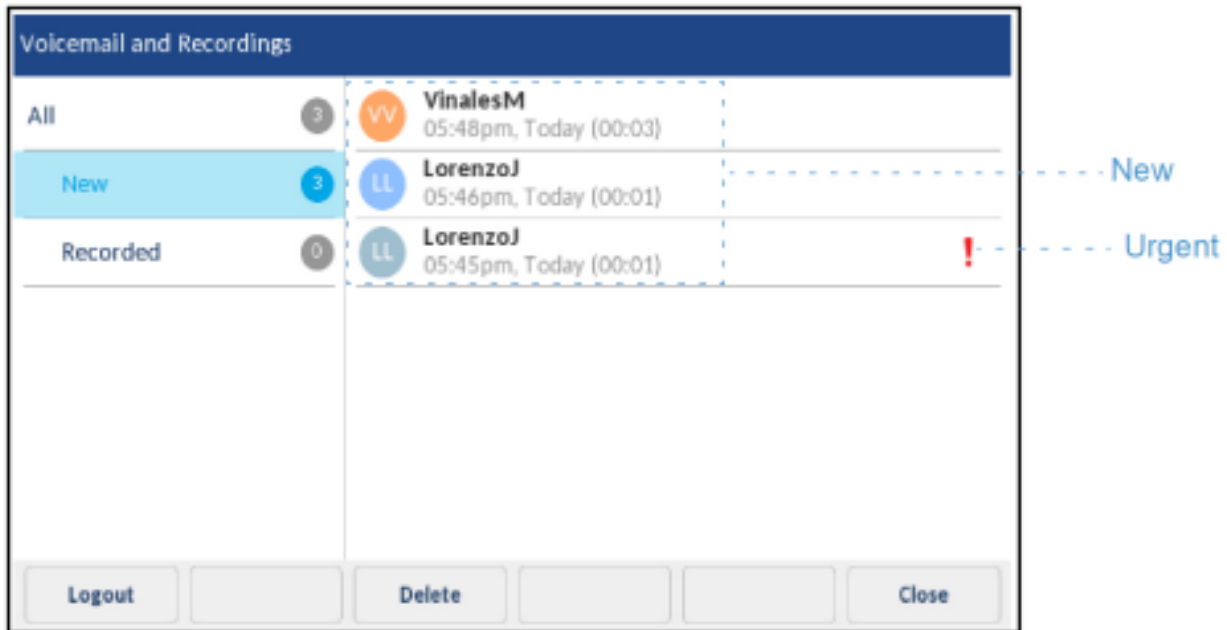

3. Tap the voicemail you want to send.

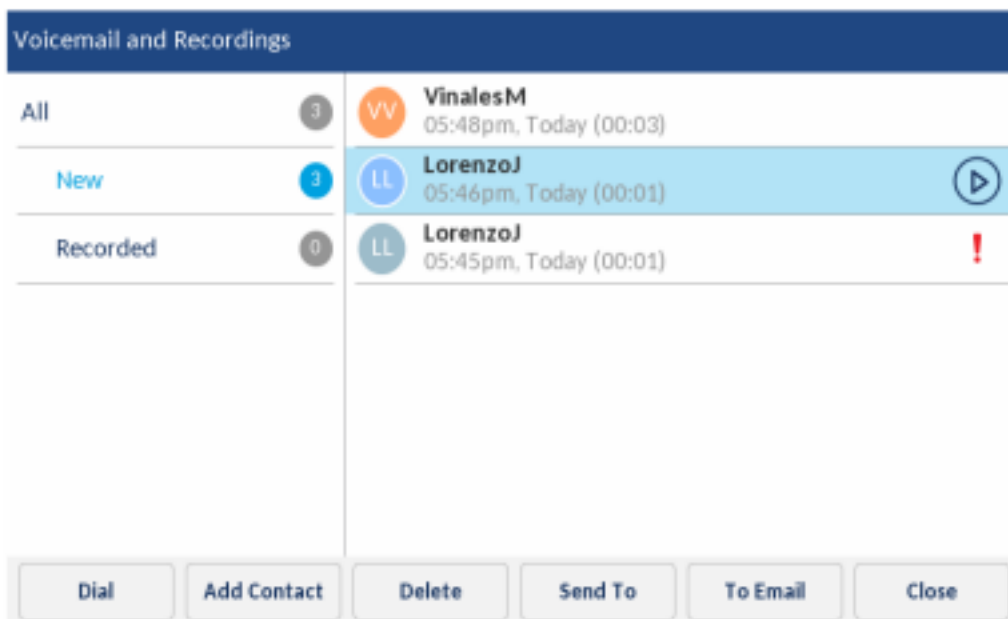

4. Tap **Send To**.

5. Tap the **Number** field and enter the number.

Voicemail Send to

To

Number

Send Backspace Cancel

6. Tap **Send** to send the voicemail to the number.

Adding voicemail number to Contacts

To add a voicemail number to the **Contacts** application:

1. Log into your voicemail.
2. Tap one of the following:
 - **All** - Displays all voicemail messages.
 - **New** - Displays new voicemail messages.
 - **Recorded** - Displays recorded voicemail messages.

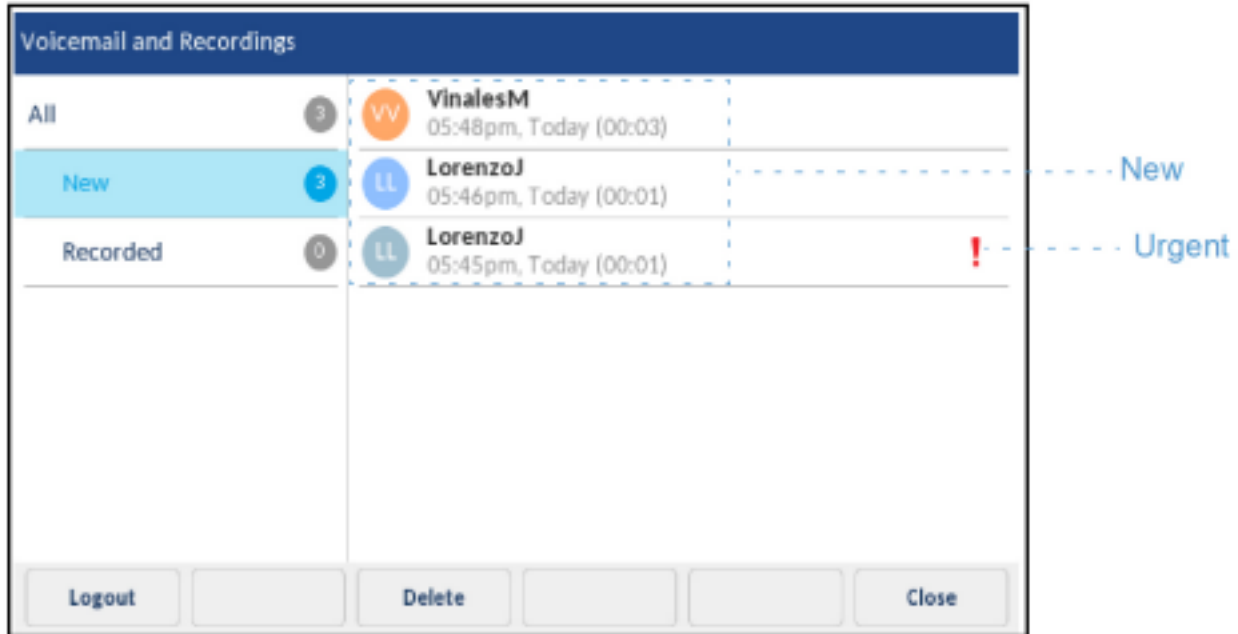

3. Tap the voicemail you want to add to the **Contacts** application.

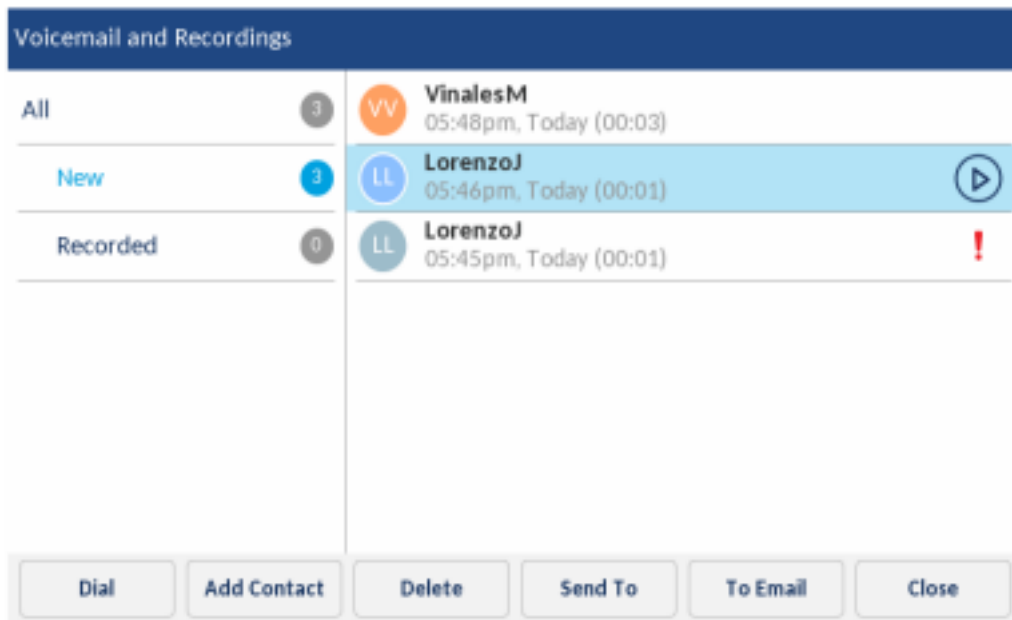

4. Tap **Add Contact**.

A add confirmation message appears on screen and the voicemail number is added to the **Contacts** application.

Emailing a voicemail

To email a voicemail:

NOTE:

- Your System Administrator must have configured the email functionality.
 - The email functionality is not supported if you have subscribed to NuPoint visual voicemail system.
1. Log into your voicemail.
 2. Tap one of the following:
 - **All** - Displays all voicemail messages.
 - **New** - Displays new voicemail messages.
 - **Recorded** - Displays recorded voicemail messages.

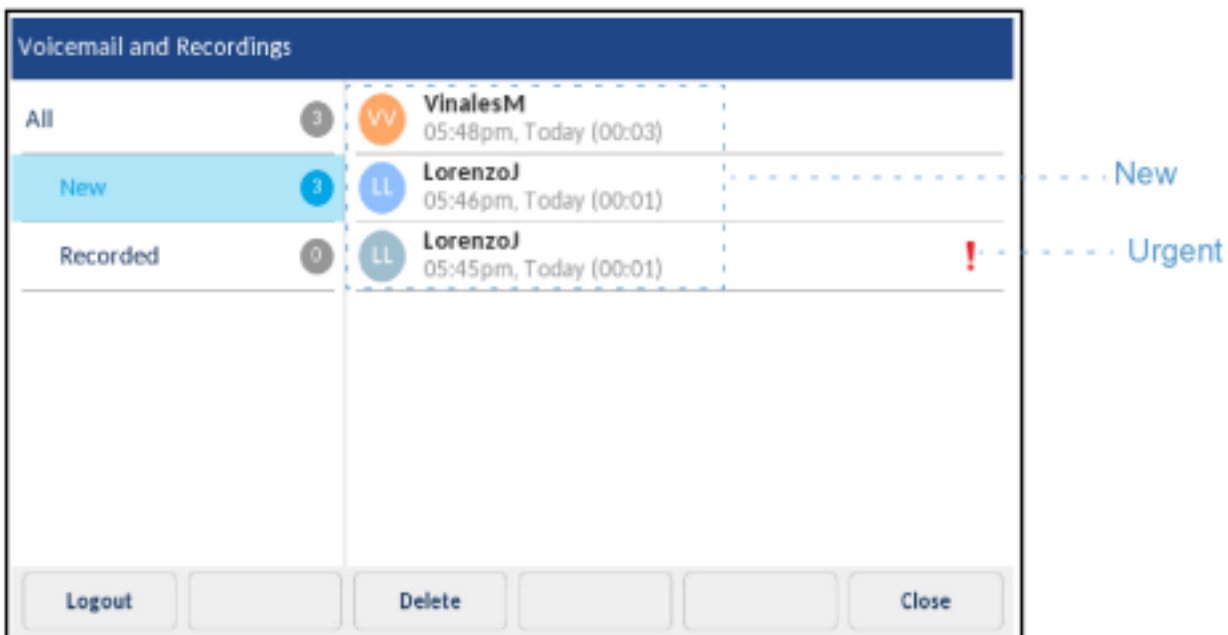

3. Tap the voicemail you want to e-mail.

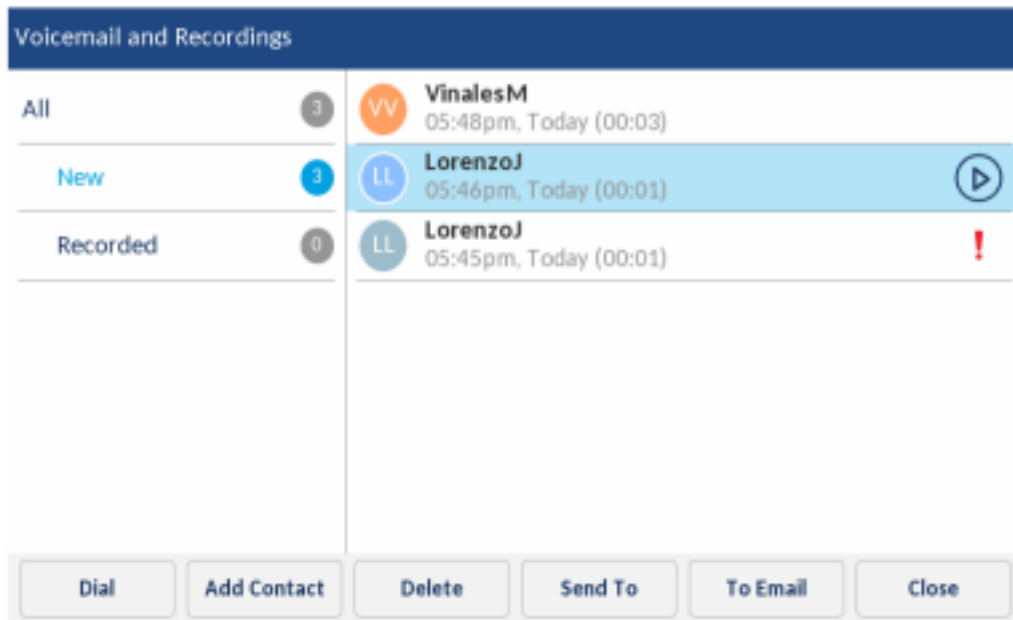

4. Tap **To Email**.

The voicemail is emailed to the address configured by your System Administrator.

MobileLink

The Mitel MiVoice 6940 IP Phone supports MobileLink, a feature that provides seamless mobile integration using Bluetooth wireless technology. MobileLink highlights include the ability to:

- Sync your mobile phone's contact list and call history with your Mitel MiVoice 6940 IP phone.
- Answer a mobile phone call using your Mitel MiVoice 6940 IP phone.
- Move mobile call audio between the Mitel MiVoice 6940 IP phone and your mobile phone.

NOTE: The MobileLink feature is supported only on iOS and Android mobile phones.

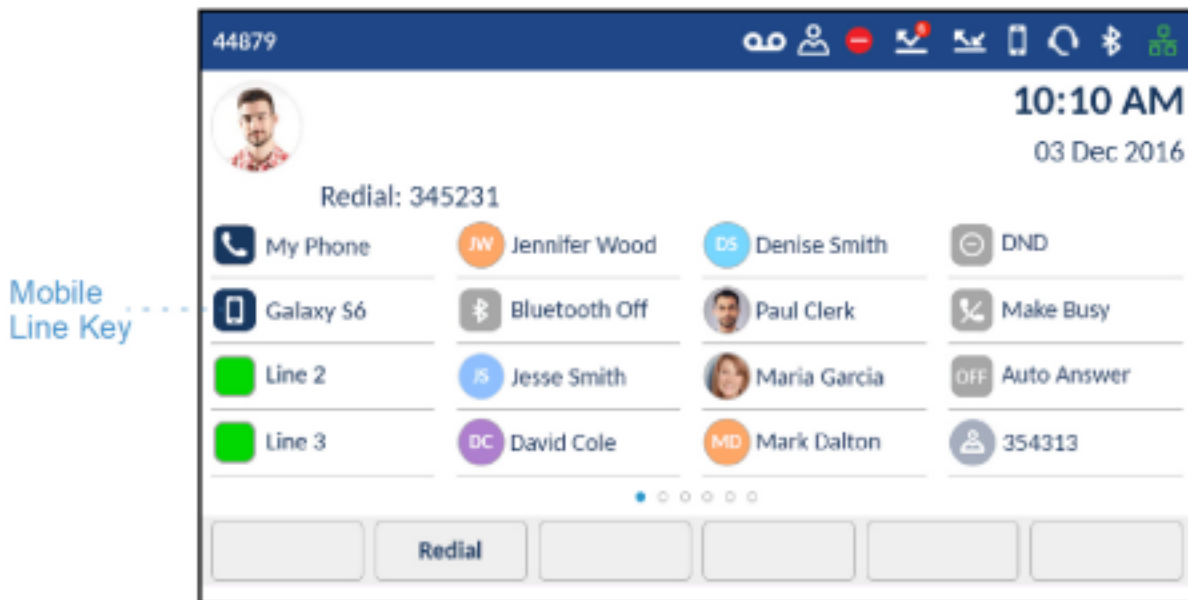

You can enable MobileLink features by one of the following ways:

- Programming a Mobile/PC Line key for your phone by your System Administrator. Contact your System Administrator for details on how to enable MobileLink functionality on your phone.
- Pressing and holding a programmable key. For more information, see [“Mobile/PC Line”](#).



The **Mobile/PC Line** key icon changes to reflect the status of the line as per the following table.

Icon	Description
	Indicates the mobile/PC line is connected with a mobile phone and is idle.
	(Blinking) Indicates the mobile/PC line is ringing due to an incoming call on your mobile phone.
	Indicates the mobile/PC line is busy.

	(Blinking) Indicates an ongoing call with active audio on the mobile phone.
	(Blinking) Indicates the call on the mobile/PC line is on hold.
	Indicates the mobile phone is not connected.

NOTE: Additional Bluetooth devices connected to your mobile phone (e.g. smartwatches, headsets, etc...) may impede or alter the behavior of the MobileLink feature. It is recommended to disconnect any additional Bluetooth devices from your mobile phone when using the MobileLink feature on your Mitel MiVoice 6940 IP Phone.

Pairing a mobile phone using Bluetooth

For instructions on how to pair your mobile phone with your Mitel MiVoice 6940 IP phone, see [“Pairing a Bluetooth device”](#).

Syncing mobile contacts

When pairing and connecting a mobile phone for the first time, the Mitel MiVoice 6940 IP phone automatically attempts to sync your mobile contacts to the **Contacts** application.

NOTE: Your initial mobile contact list will remain in the **Contacts** application even if you connect to a secondary mobile phone. To update your mobile contacts so that they are aligned with the secondary mobile phone, you must manually synchronize your mobile contacts.

To manually update your mobile contacts:

1. Ensure you have paired your mobile phone with your 6940 IP phone. See [“Pairing a Bluetooth device”](#).
2. Press the  (**Contacts**) key.

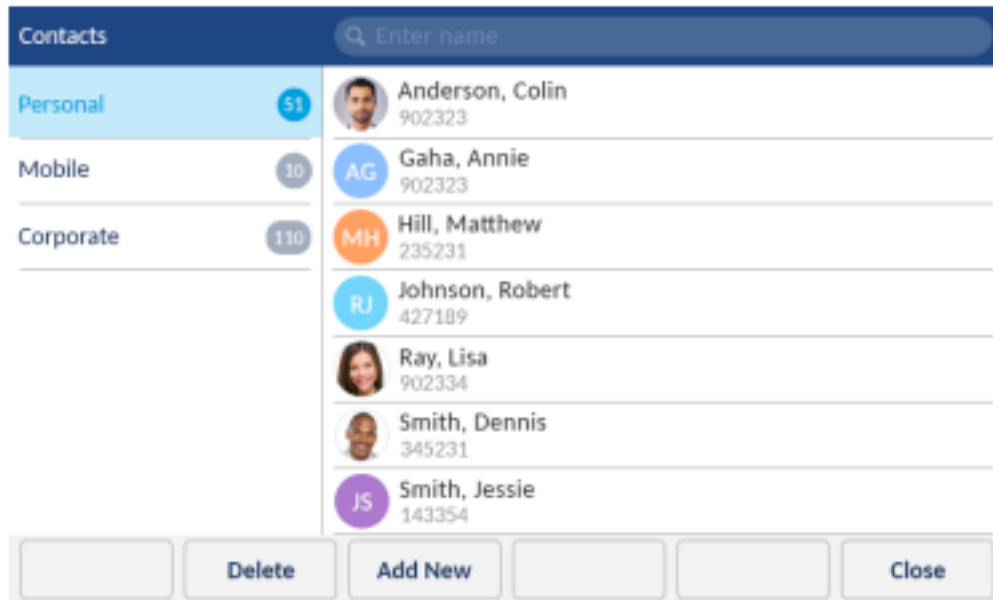

3. Tap the **Mobile** contacts folder.

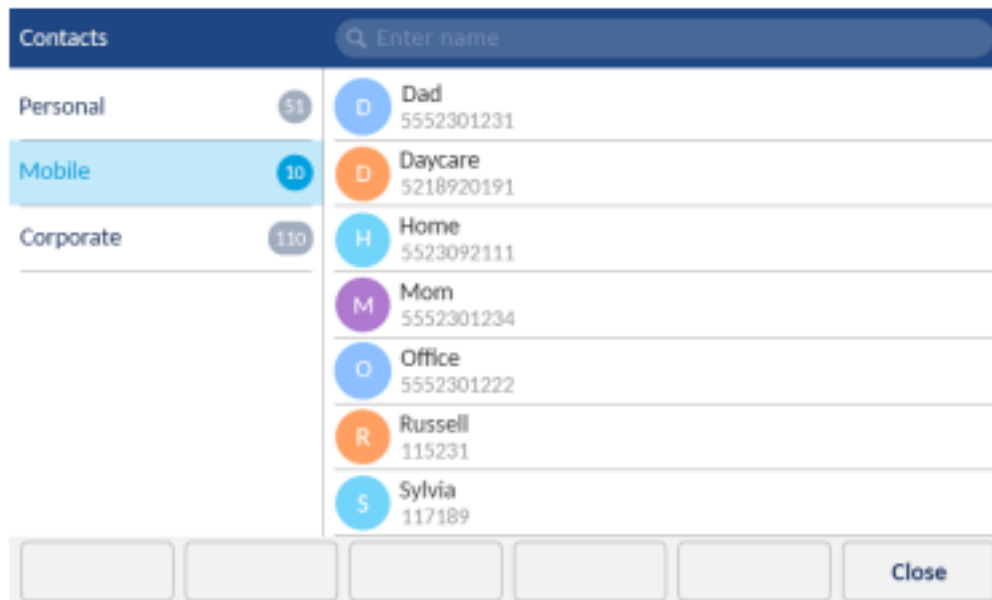

4. Tap the **Update** softkey.

The Mitel MiVoice 6940 IP phone attempts to re-synchronize and update your mobile contacts.

NOTE:

- a. You may need to acknowledge the request on your mobile phone.
- b. If the update fails, a failed to retrieve contacts message displays on screen. Tap **Retry** to attempt to update again, or **Cancel** to cancel the attempt.
- c. Some mobile phones will only sync contacts stored on the phone's flash memory. Contacts stored on the phone's SIM card may not sync with the Mitel MiVoice 6940 IP phone.

- d. Mobile contacts are cleared from the **Contacts** application when the phone's firmware has been upgraded. If your mobile device is configured to allow for automatic re-synchronization, the Mitel MiVoice 6940 IP phone will synchronize the contacts again the next time your mobile device connects to your IP phone. If your mobile device is not configured for automatic re-synchronization, you must manually synchronize your mobile contacts.
- e. Mobile phone contacts are cleared from the Contacts application when the Bluetooth connectivity is lost. The mobile phone contacts are resynced when the Bluetooth connectivity is reestablished.
- f. For more information on the **Contacts** application, see "[Contacts](#)".

Syncing mobile call history

When pairing and connecting a mobile phone for the first time, the Mitel MiVoice 6940 IP phone automatically syncs your mobile call history to the **Call History** application. Your mobile phone call history is displayed in the **My Mobile** and **Missed** folders. The **My Mobile** folder displays your mobile phone call history (missed, outgoing, and received calls) with icons. The **Missed** folder displays only your mobile phone missed calls without icons. Up to 1000 call history entries are displayed in the **My Mobile** folder, in the order latest to oldest.

The call history details displayed are name (if available), number (if available), time, and date. The call duration details are not displayed.

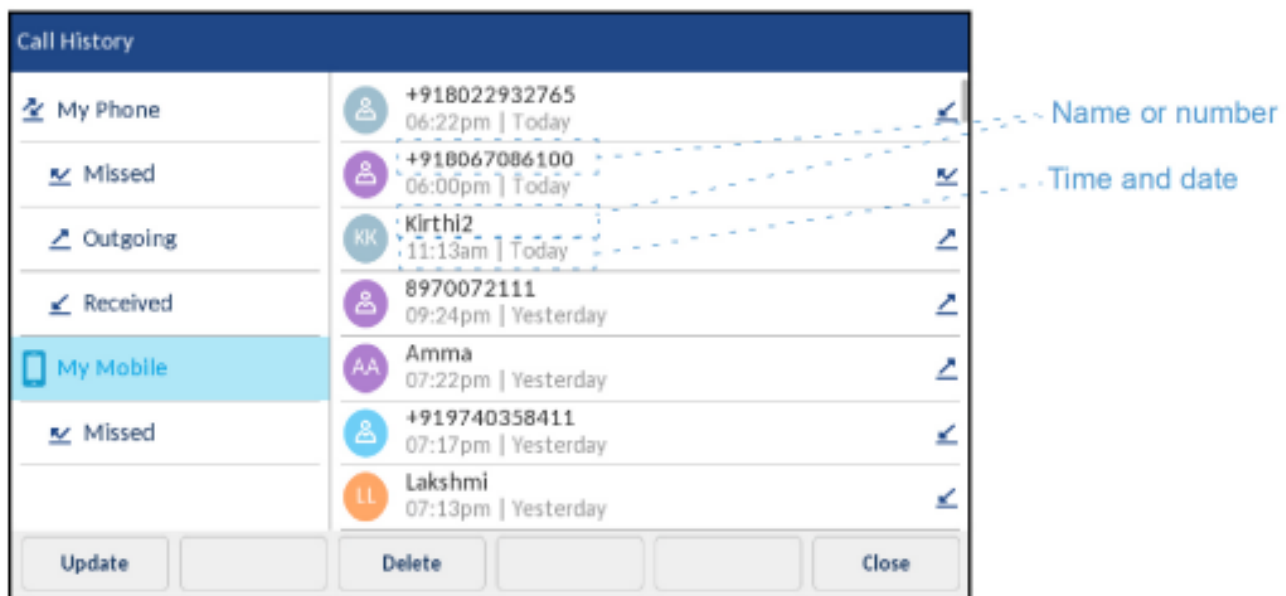

Automatic update of your mobile phone call history is not supported. For example, if a user receives a call on the mobile phone, the call record is not automatically updated in the **Call History** application. The call record is updated the next time when the mobile phone connects to the 6940 IP phone or by a manual update.

NOTE:

1. You may need to acknowledge the request for Contact sharing on your mobile phone.
2. If the update fails, a failed to retrieve contacts message displays on screen. Tap **Retry** to attempt to update again, or **Cancel** to cancel the attempt.

3. Picture avatar is not supported for mobile phone call history.
4. If you pair a second mobile phone with your 6940 IP phone, the 6940 IP phone automatically syncs the mobile **call history** of the second mobile phone to the Call History application. To re-sync the mobile call history of your first (or an already paired) mobile phone to the **Call History** application, connect the mobile phone to your 6940 IP phone.
5. The **Call History** application stores and displays the mobile phone call history even when the paired mobile phone is not connected to your 6940 IP phone.
6. The mobile phone call history is lost when the mobile phone is unpaired or your 6940 IP phone resets.
7. Mobile phone call history is supported for Hot Desk users. When a Hot Desk user logs in, the mobile phone call history of the Hot Desk user's paired mobile phone is displayed. When the Hot Desk user logs out, the mobile phone call history of mobile phone paired with the registered extension is displayed.
8. Mobile phone call history is cleared from the Call History application when the Bluetooth connectivity is lost. The mobile phone call history is resynced when the Bluetooth connectivity is reestablished.

Viewing mobile call history

To view your mobile phone call history:

1. Ensure that you have paired your mobile phone with your 6940 IP phone. See [“Pairing a Bluetooth device”](#).
2. Press the  (**Call History**) key.
3. Tap **My Mobile**.

Your mobile phone call history is displayed on the screen.

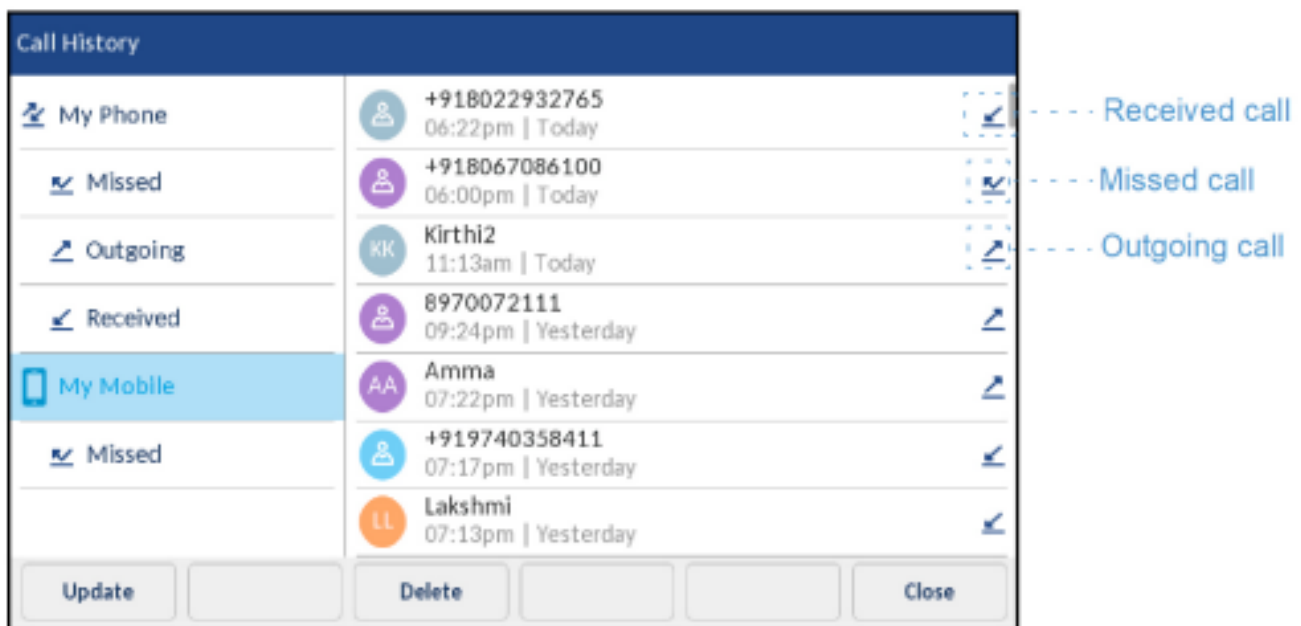

Viewing mobile missed calls

To view mobile missed calls:

1. Ensure that you have paired your mobile phone with your 6940 IP phone. See [“Pairing a Blue-tooth device”](#).
2. Press the  (**Call History**) key.
3. Tap **Missed**.

Your mobile phone missed calls is displayed on the screen.

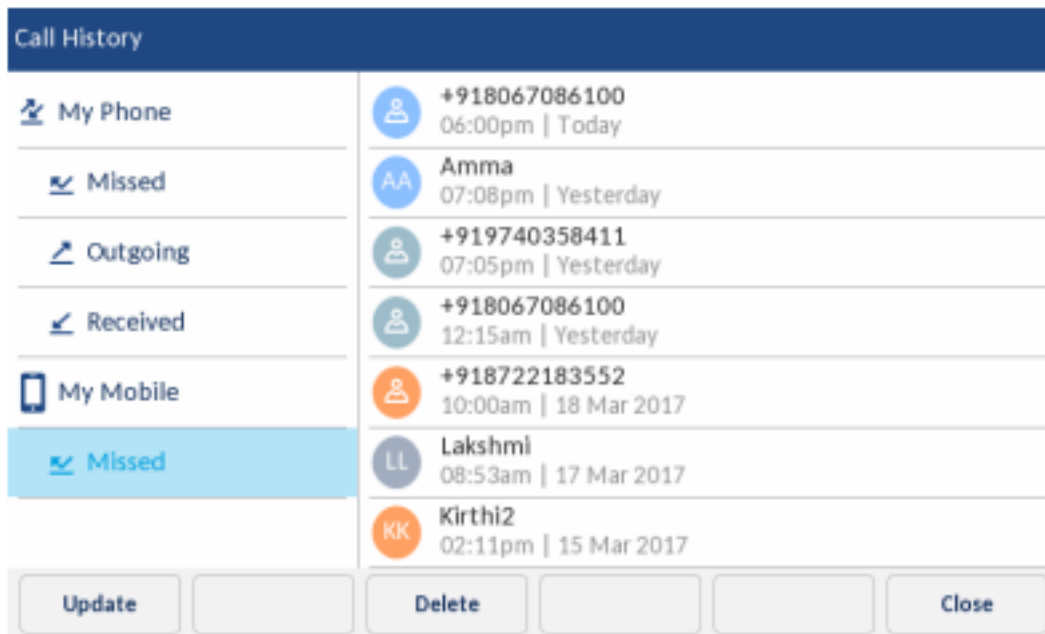

Viewing details of a mobile call history or missed call entry

To view details of a mobile call history or missed call entry:

1. Navigate to **My Mobile** or **Missed** folder. See [“Viewing mobile call history”](#) or [“Viewing mobile missed calls”](#).
2. Tap the call history or missed calls entry in the selection column for which you want to view the details, and then tap the right-arrow.

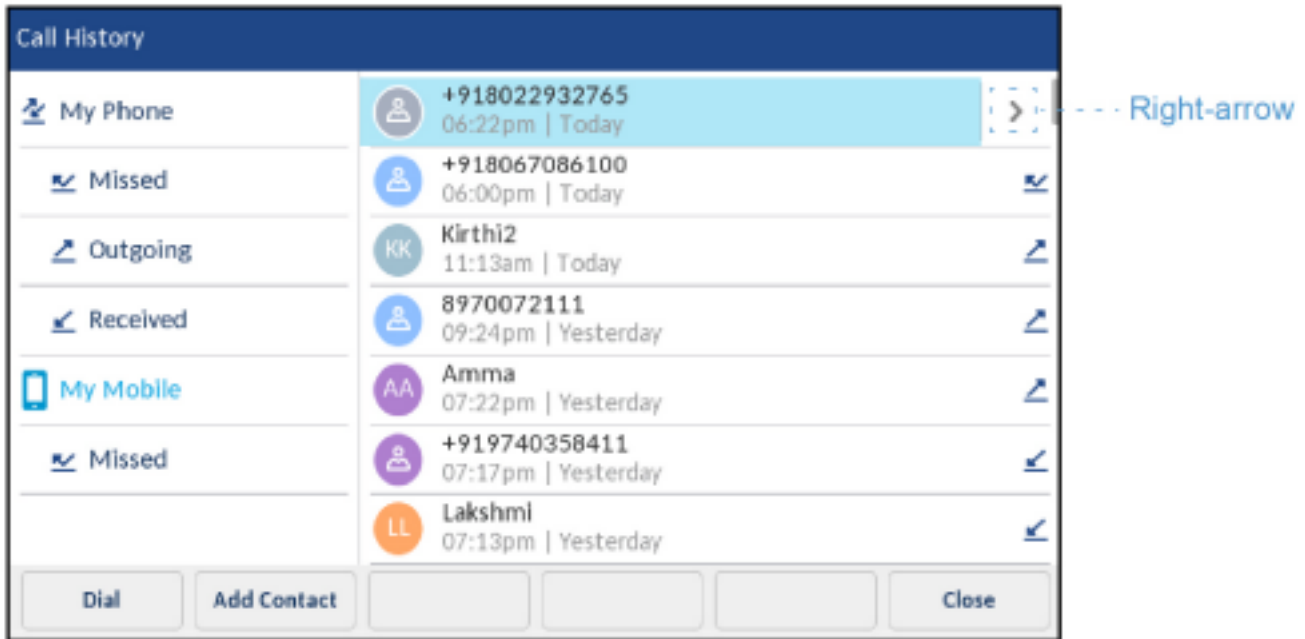

The details of the mobile call history or missed call entry is displayed on screen.

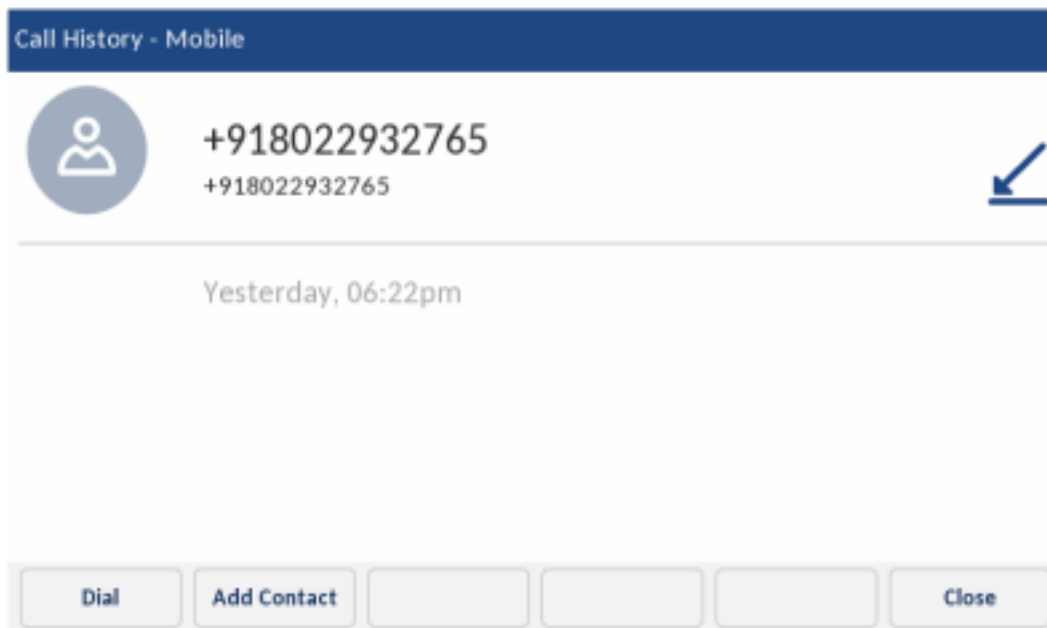

NOTE:

- a. Tap **Dial** to dial the number associated with the entry.
- b. Tap **Add Contact** to add the entry to the **Contacts** application.

Updating mobile call history and missed calls

To manually update your mobile call history and missed calls:

1. Ensure that you have paired your mobile phone with your 6940 IP phone. See [“Pairing a Blue-tooth device”](#).
2. Press the  (**Call History**) key.
3. Tap **My Mobile** or **Missed**, and then tap the **Update** softkey.

Your mobile call history and missed calls are updated on your 6940 IP phone.

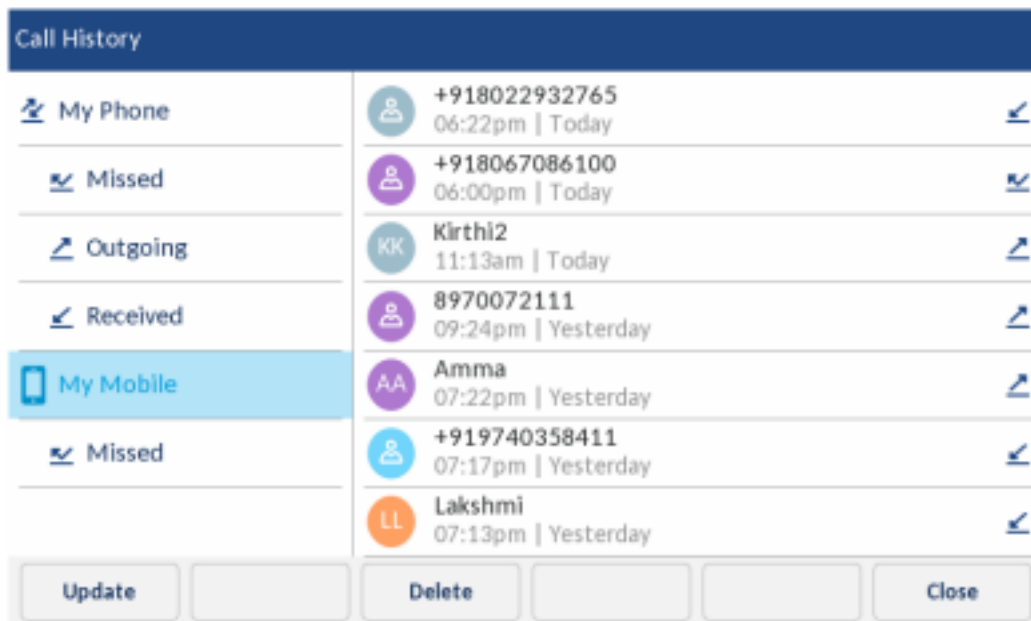

Dialing a mobile phone call history entry

To dial a mobile phone call history or missed call entry:

1. Ensure that you have paired your mobile phone with your 6940 IP phone. See [“Pairing a Bluetooth device”](#).
2. Press the  (**Call History**) key.
3. Tap **My Mobile** or **Missed**.

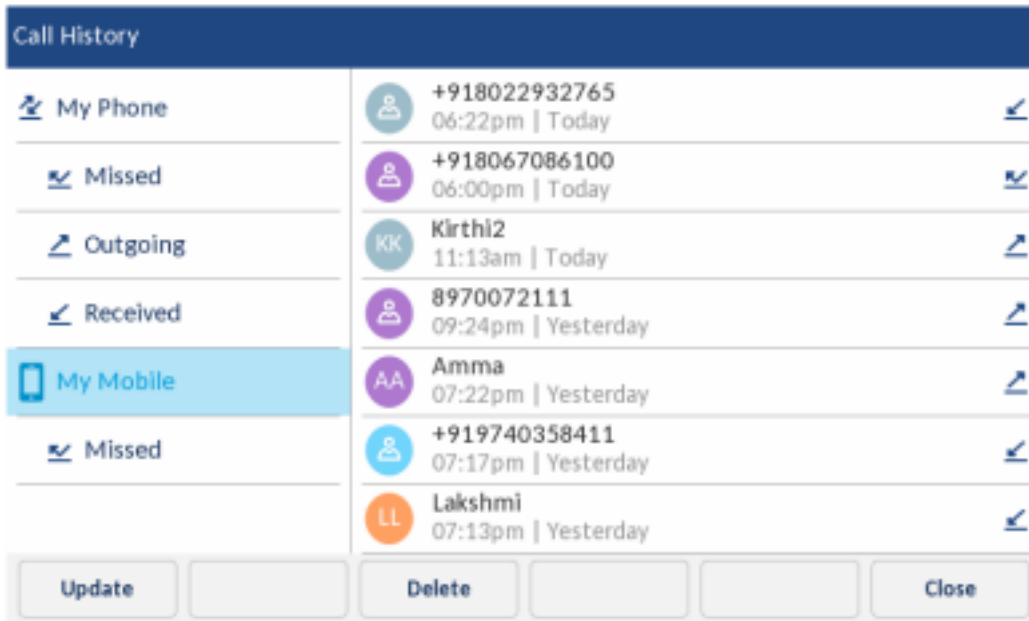

4. Tap an entry in the call history or missed calls selection column.

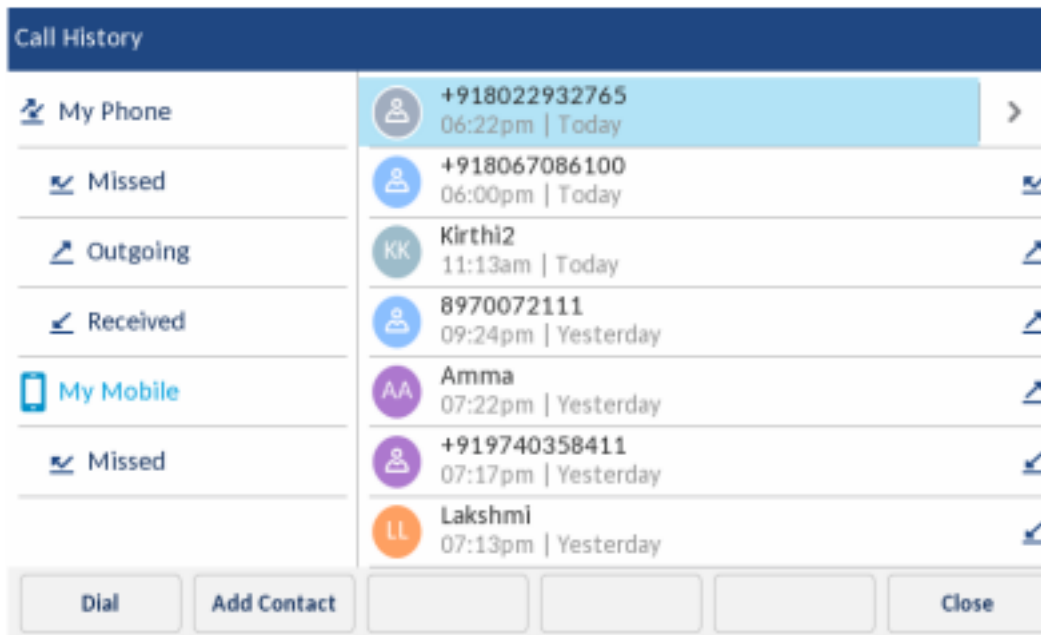

5. Tap **Dial** to dial the number associated with the entry.

Adding an entry to Contacts

To add a mobile phone call history or missed call entry to the **Contacts** application:

1. Ensure that you have paired your mobile phone with your 6940 IP phone. See [“Pairing a Bluetooth device”](#).
2. Press the  (**Call History**) key.
3. Tap **My Mobile** or **Missed**.

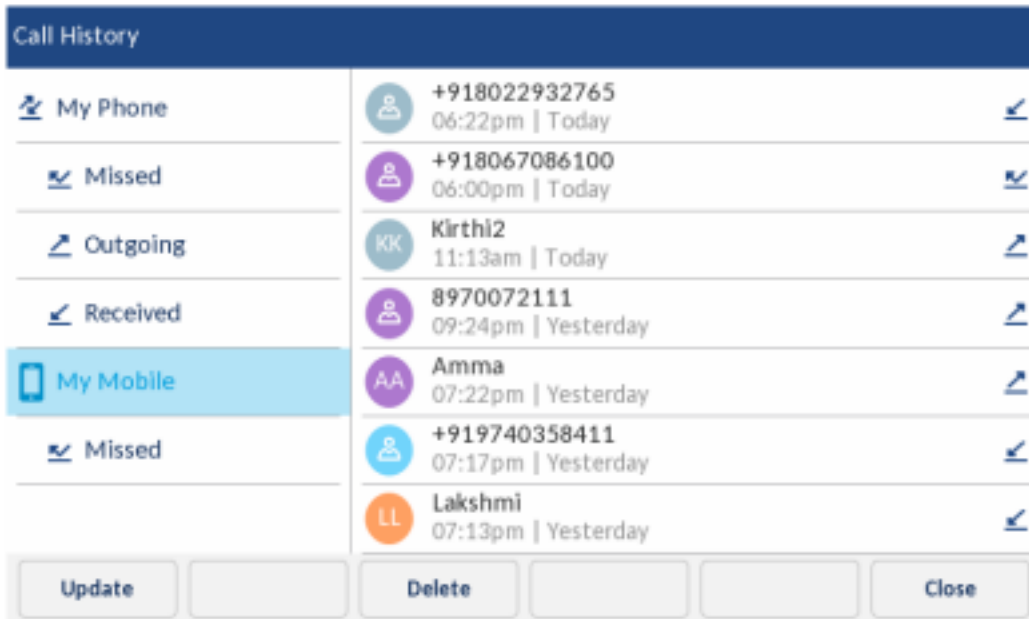

4. Tap an entry in the call history or missed calls selection column.

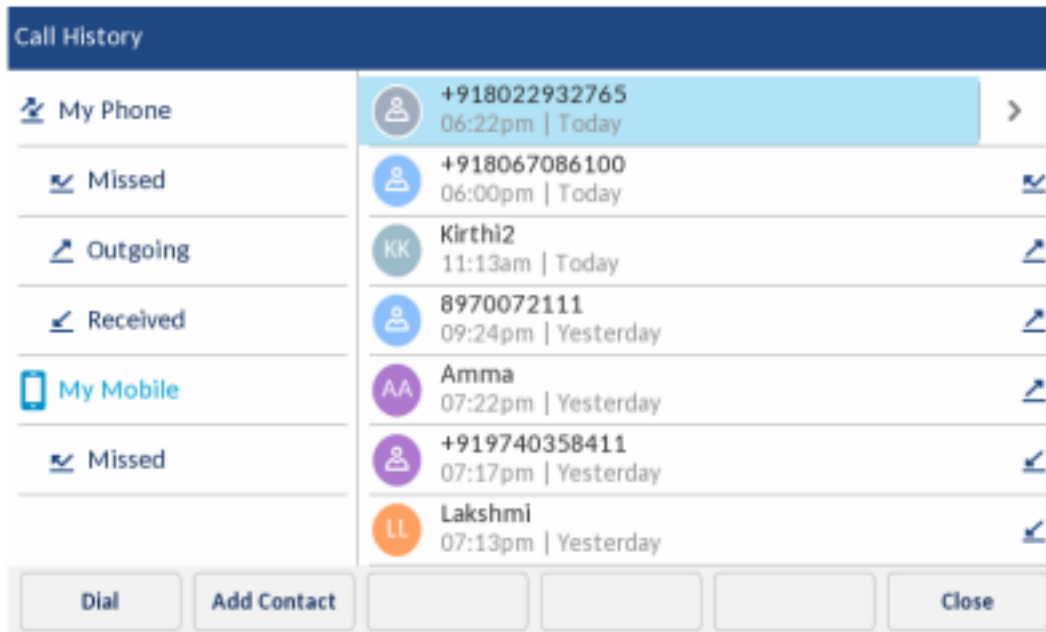

5. Tap **Add Contact** to add the entry to the **Contacts** application.

Deleting mobile call history and missed call

To delete mobile call history and missed calls:

CAUTION: Deleting a specific call history or missed call record is not supported. Tapping **Delete** deletes all the entries (mobile phone call history and missed calls) in the **My Mobile** folder.

1. Ensure that you have paired your mobile phone with your 6940 IP phone. See [“Pairing a Bluetooth device”](#).
2. Press the  (**Call History**) key.
3. Tap **My Mobile** or **Missed**, and then tap **Delete**.

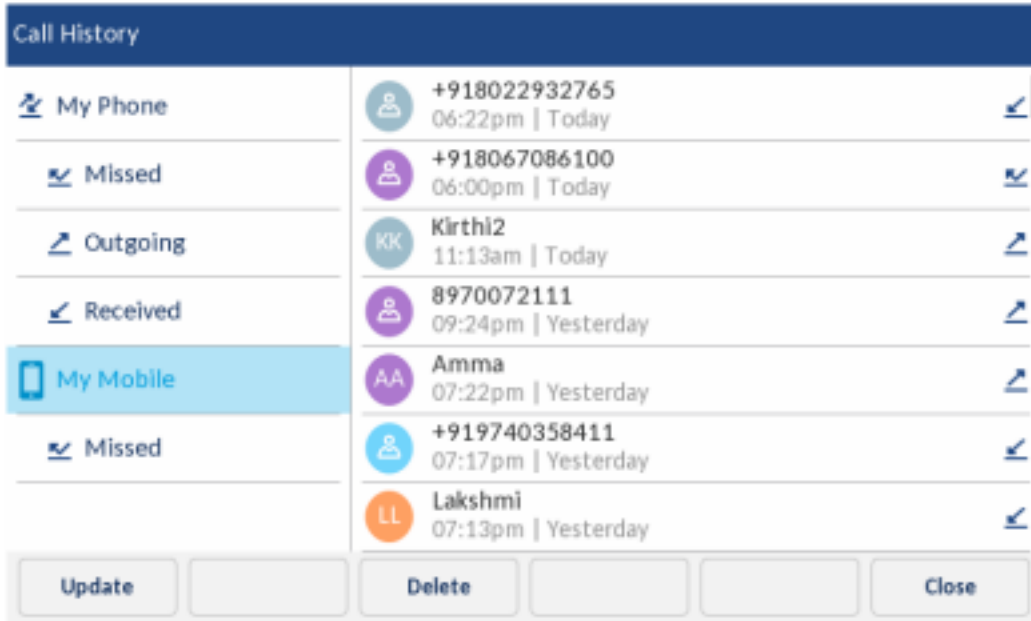

A delete all confirmation message appears on screen.

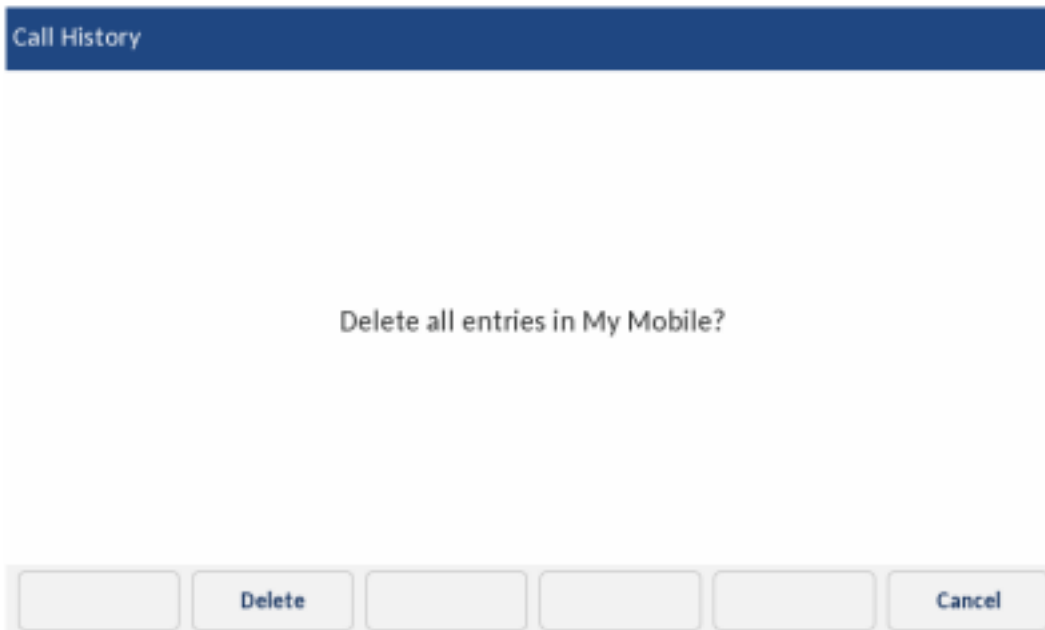



4. Tap **Delete** to delete all entries in the **My Mobile** folder.

Answering an incoming mobile call using your Mitel MiVoice 6940 IP phone

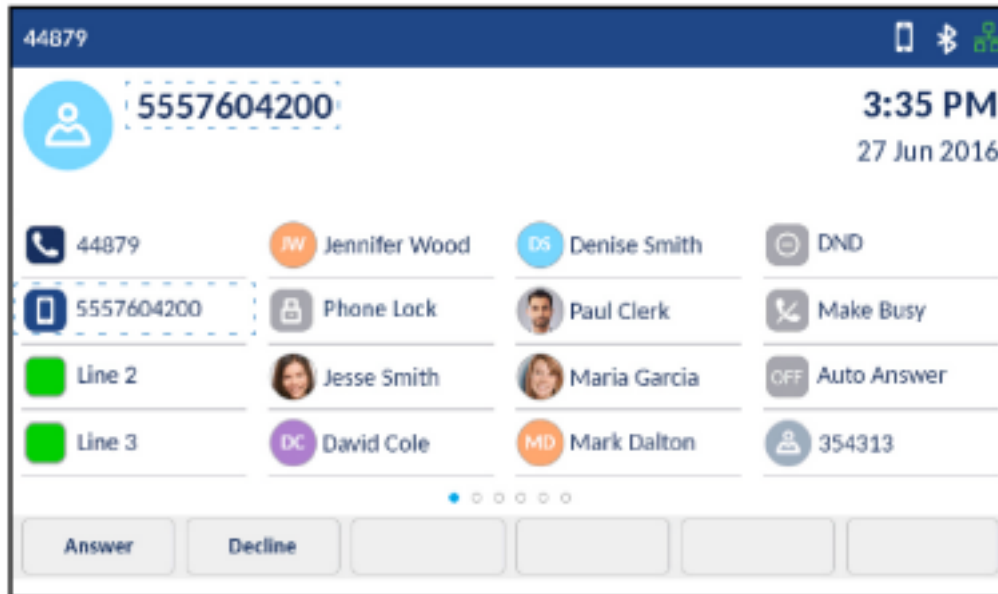
When your mobile phone is paired and connected to your Mitel MiVoice 6940 IP phone, incoming calls on your mobile phone will be indicated on your Mitel MiVoice 6940 IP phone as well.



To answer the incoming mobile call using your Mitel MiVoice 6940 IP phone, lift the handset for handset operation, or press the  (**Speaker/Headset**) key, tap the blinking  **Bluetooth Line** key, or tap the **Answer** softkey for handsfree operation.

NOTE:

1. Tap the **Decline** key to reject the incoming mobile phone call.
2. During an ongoing call using the Mitel S720 Bluetooth Speakerphone, if your Mitel MiVoice 6940 IP phone is paired with your mobile phone, the audio on S720 is interrupted on receiving an incoming call on the mobile phone.

Moving audio from an active mobile call between your mobile phone and Mitel MiVoice 6940 IP phone

Switching mobile phone audio from your Mitel MiVoice 6940 IP phone to your mobile phone and back again is performed by a one-key-tap method.

Tap the **Push call** softkey to push the mobile call audio from your Mitel MiVoice 6940 IP Phone to your mobile phone.

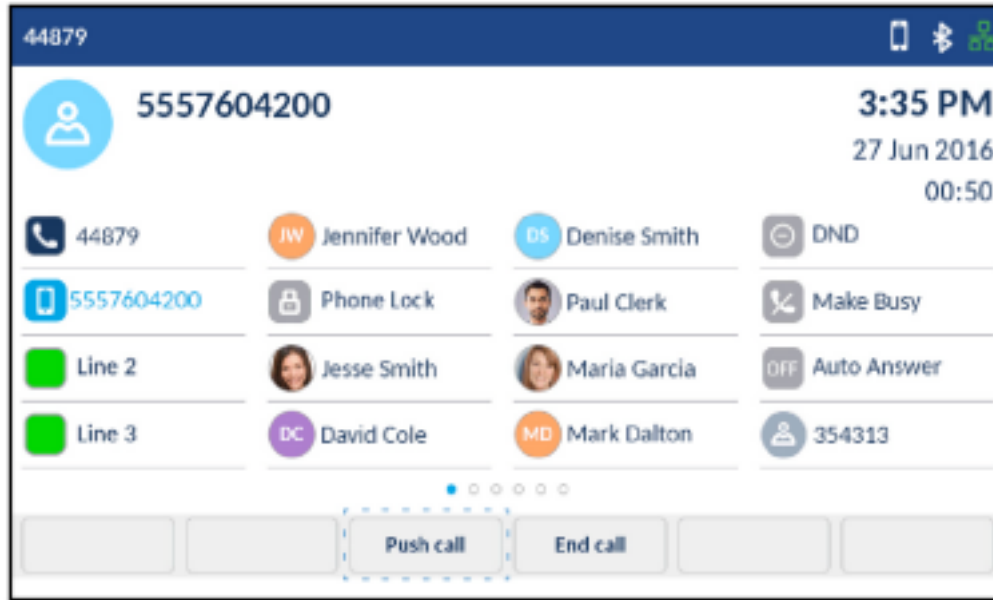

Tap the  **Mobile/PC Line** key to pull the mobile call audio from your mobile phone to the Mitel MiVoice 6940 IP Phone.



PCLink for 6940 IP Phone

The PCLink feature enables Mitel 6940 IP Phone to be used as the audio device for PC or MAC video collaboration with all the supported video collaboration applications, for both Windows 10 and MAC operating systems, through the IP Phone's Bluetooth interface.

You can configure the PCLink feature with any of the video collaboration applications by using the following steps:

1. [Configure the Mitel 6940 IP Phone](#)
2. [Pair the Mitel 6940 IP Phone with Windows or MAC](#)
3. [Configure Collaboration Applications](#)

Configure the Mitel 6940 IP Phone

To use PCLink on the Mitel 6940 IP Phone, you must program the Mobile/PC Line feature.

NOTE: Check if **Mobile/PC Line** key is programmed on your phone by looking for the **Connect** softkey on the home screen of your phone. If yes, ignore the below procedure.

To program a **Mobile/PC Line** key:

1. Press and hold an available (blank) programmable key until the programming menu appears. If Long Key press does not work, contact your System Administrator.
2. Press the left navigation key or tap to move to the feature category column.
3. Press the down navigation key or tap to highlight **Other Features**.
4. Press the right navigation key or tap to move to the **Other Features** selection column.
5. Press the down navigation key or tap to navigate to **Mobile/PC Line**.

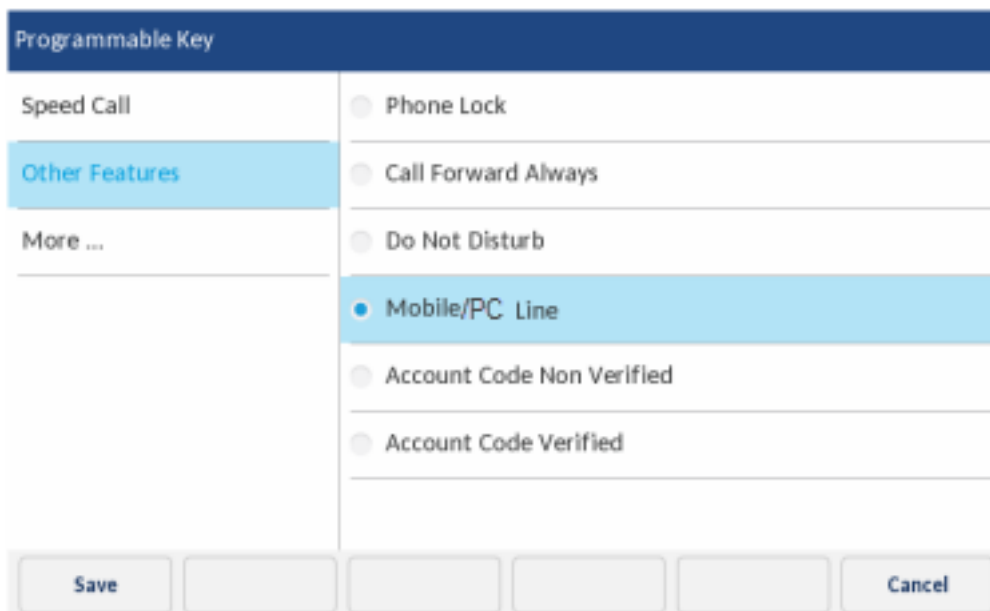

6. With **Mobile/PC Line** highlighted, press the **Save** softkey.



NOTE:

- You can program only one Mobile/PC Line key.
- Contact your System Administrator for details about enabling Mobile Link functionality on your Mitel 6940 IP Phone.

Pair the Mitel 6940 IP Phone with Windows or MAC

Pair the Mitel 6940 IP Phone with PC on Windows 10

To pair the Mitel 6940 IP phone with PC on Windows 10:

1. Click Windows menu  > **Settings**.
2. Navigate to **Devices**.
3. Click **Bluetooth & other devices** in the left sidebar.
4. Set the toggle switch  at the top to **On**.
5. To add the 6940 IP Phone to the list of available devices, click **Add Bluetooth or other device**.
6. Select **Bluetooth**.
7. Ensure that the 6940 IP Phone is in the **Available Devices** menu. Navigate to **Settings > Bluetooth > Available Devices** to enter the **Available Devices** menu of the IP Phone.
8. Choose the **Mitel 6940...** from the available list of devices on your PC.
9. A Bluetooth pairing request displays on both the 6940 IP Phone and the PC. Ensure that the pairing code matches on both devices. Press **Yes** on the 6940 IP Phone and press **Connect** on the PC to pair the phone with the PC.

NOTE:

- You can pair the PC with the 6940 IP Phone only from the PC and not from the 6940 IP Phone. If you try to initiate pairing from the 6940 IP Phone, the following message appears.

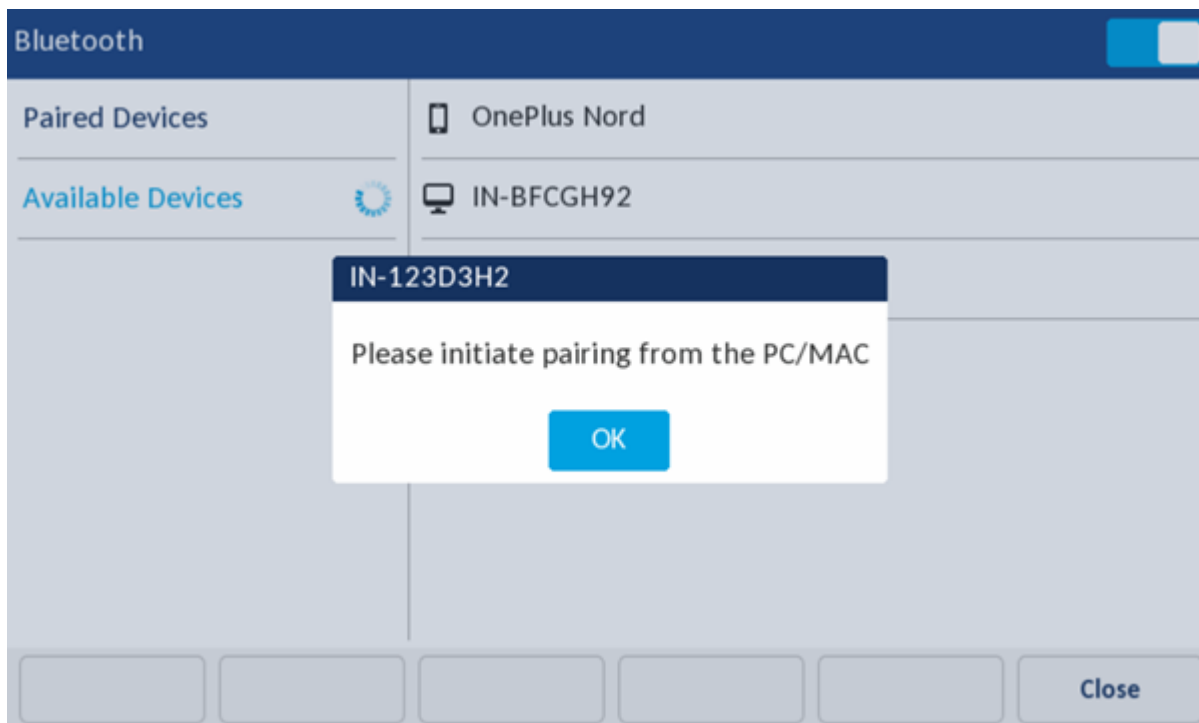

- After your PC is paired with the 6940 IP Phone, the PC device appears in the list of paired devices on the Mitel 6940 IP Phone. If there is no device currently paired with the Mobile/PC Line key, the device will connect automatically.

IMPORTANT: ENSURE THE 6940 IP PHONE IS NOT THE DEFAULT AUDIO DEVICE ON THE PC.

For Windows 10 left-click on the sound ICON in the windows tray and select an audio device other than the Mitel 6940 IP Phone.

- After pairing, You can switch audio between wired handset, speaker, analog headset, and USB headset

NOTE: You cannot switch the audio to a 6940 Cordless Handset.

- You can toggle between PC audio and IP Phone.
- Currently only one device type (Mobile or PC) can be connected at a time. If there is already a PC or MAC connected to the IP Phone, and a mobile phone is the newly paired device, the following messages appear:

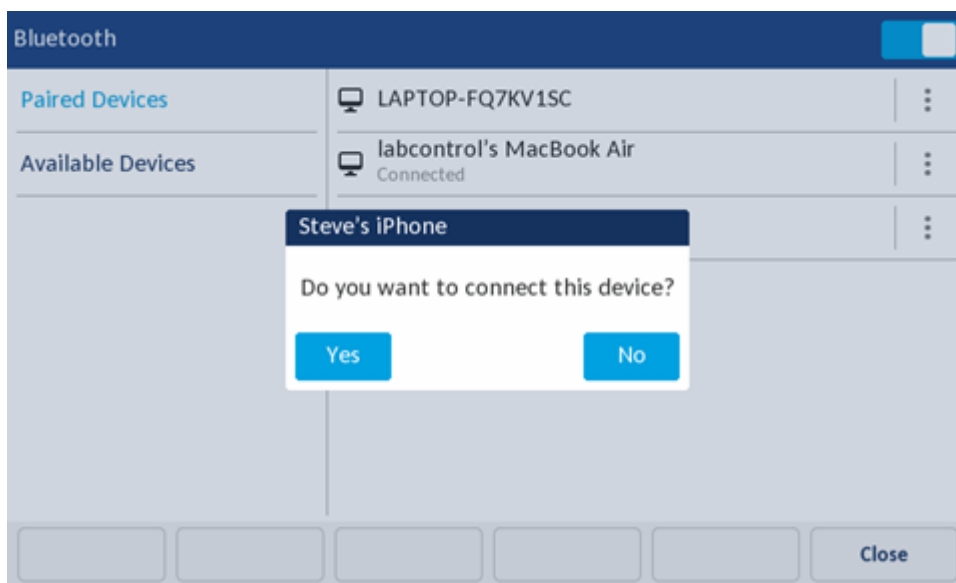

- Pressing **Yes** will disconnect the PC or MAC and connect the mobile phone and associate it to the Mobile/PC Line key.
- Pressing **No** will result in the mobile phone not being connected, although the mobile phone remains in the list of paired devices. The user can, at any time, manually switch which device is connected and associated with the Mobile/PC Line key by selecting the device in the list of paired devices. A confirmation dialog, similar to one of those shown in the next two screen captures appear (depending on the currently connected device type).

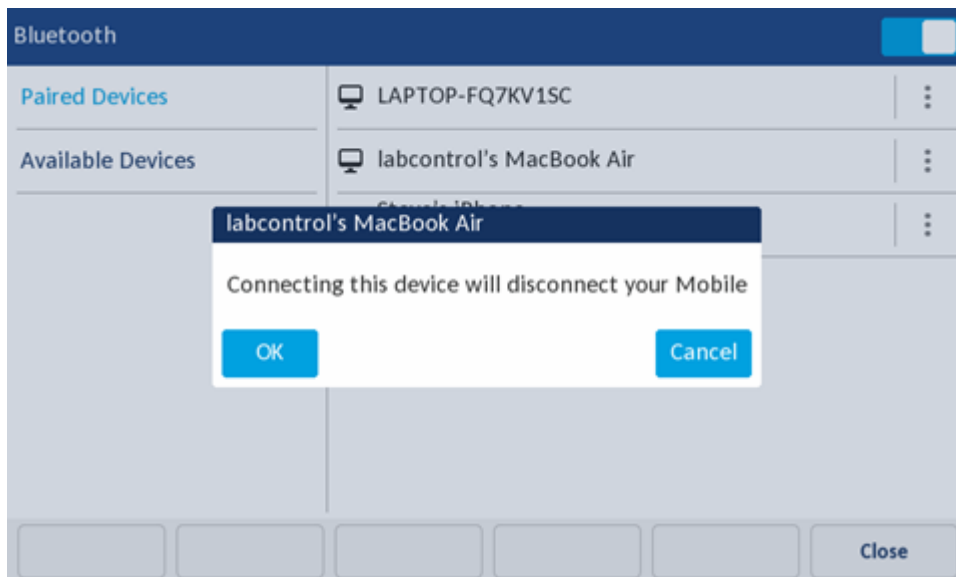
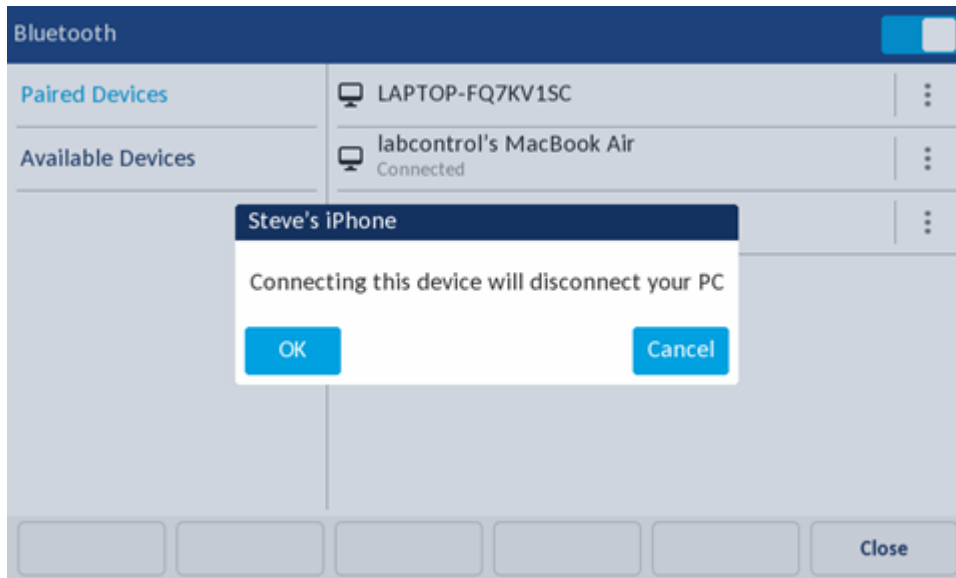

Pair the Mitel 6940 IP Phone with a MAC Device

To pair the Mitel 6940 IP phone with a MAC device:

1. On your MAC device, choose the device from the Bluetooth status menu (📶) in the menu bar. If your device is connecting for the first time, choose **Connect**.
2. If the Bluetooth status icon is not displayed in the menu bar, choose Apple menu 🍏 > System Preferences, and click **Bluetooth**.
3. Select **Show Bluetooth** in menu bar.

NOTE: If Bluetooth is not listed in System Preferences, your computer does not support Bluetooth.
4. Ensure that the 6940 IP Phone is in the **Available Devices** menu. Navigate to **Settings > Bluetooth > Available Devices** to enter the **Available Devices** menu of the IP Phone.
5. Follow the on-screen instructions on the MAC device to set up the device.

IMPORTANT: ENSURE THE 6940 IP PHONE IS NOT THE DEFAULT DEVICE ON THE MAC. For MAC OS option, click on the sound ICON in the screen header and select an audio device other than the Mitel 6940 IP Phone.

Configure Collaboration Applications

After pairing the Mitel 6940 IP Phone with your system, you must configure the video collaboration application you will use. In this example, we will configure Mitel MiTeam Meetings as the collaboration application.

To configure the Mitel MiTeam Meetings application to use the Mitel 6940 IP Phone as the audio device:

1. Launch the MiTeam Meetings application on your PC or MAC.
2. Join a meeting.
3. Access the **Settings** panel by doing either of the following:
 - From the MiTeam Meetings home screen, click your avatar and from the panel that opens, click **Settings**.
 - Click  from the control panel. The **Settings** panel is displayed.
4. Click the **Audio** tab.
5. To move audio from the currently selected audio device to the Mitel 6940 IP Phone:
 - a. From the **Microphone** drop-down list, select **Mitel 6940...** (for either Communications or Headset if both are listed).

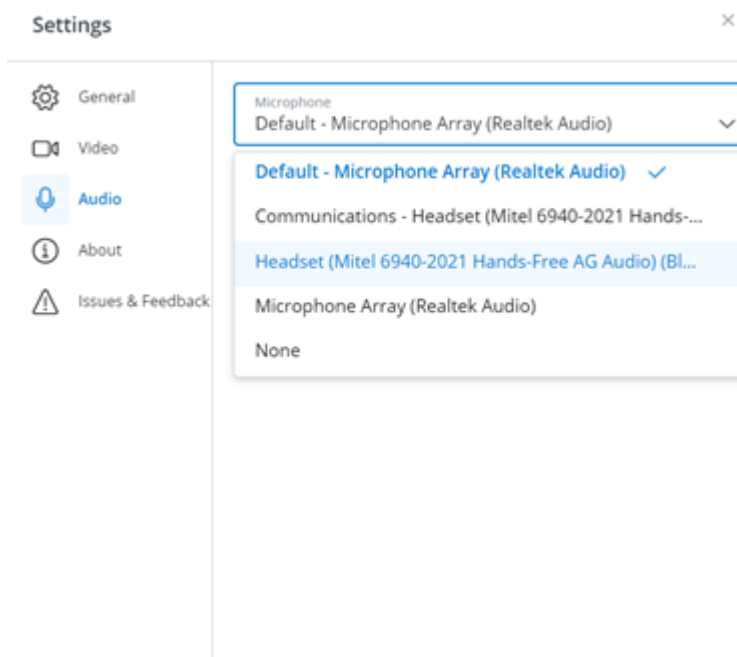

- b. From the **Speaker** drop-down list, select **Mitel 6940...** (for either Communications or Headset if both are listed).

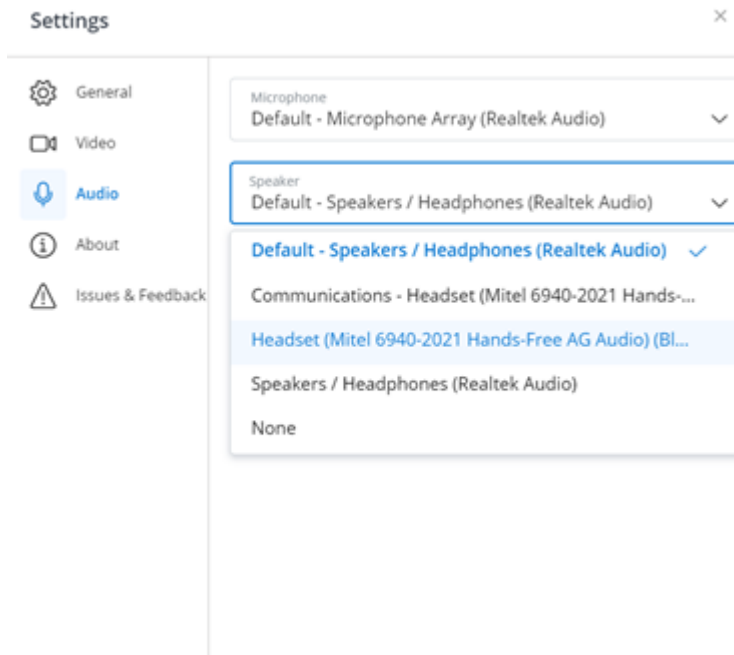

Understanding IP Phone Call Behavior with PCLink

The following summarizes the behavior of the Mitel 6940 IP Phone under various call states:

- **General Usability**
- **When the IP Phone is Idle or Ringing**
- **When the IP Phone is on an active VoIP Call**
- **When the IP Phone is in a DND or Locked State**

General Usability

- The user can mute or unmute the PCLink audio on the phone by pressing the phone's Mute hard key.
 - NOTE:** This mute is local to the phone and will not be reflected within the PC application mute state.
- The volume control buttons on the phone operate independently of the volume controls on the PC.
- If the user is on a PCLink session on the Mitel 6940 IP Phone (that is, has started a PC application that has the Mitel 6940 IP Phone set as the audio device) while there is an incoming call on the Mitel 6940 IP Phone, the IP Line key flashes and displays the Caller ID of the caller. The following is the behavior associated with answering the incoming IP Phone call:
 - If the user presses the IP line key to answer the call, a pop-up dialog appears indicating that the PC is temporarily disconnected and the audio is now on your PC. We recommend that you mute your meeting application on the PC before answering the IP call.

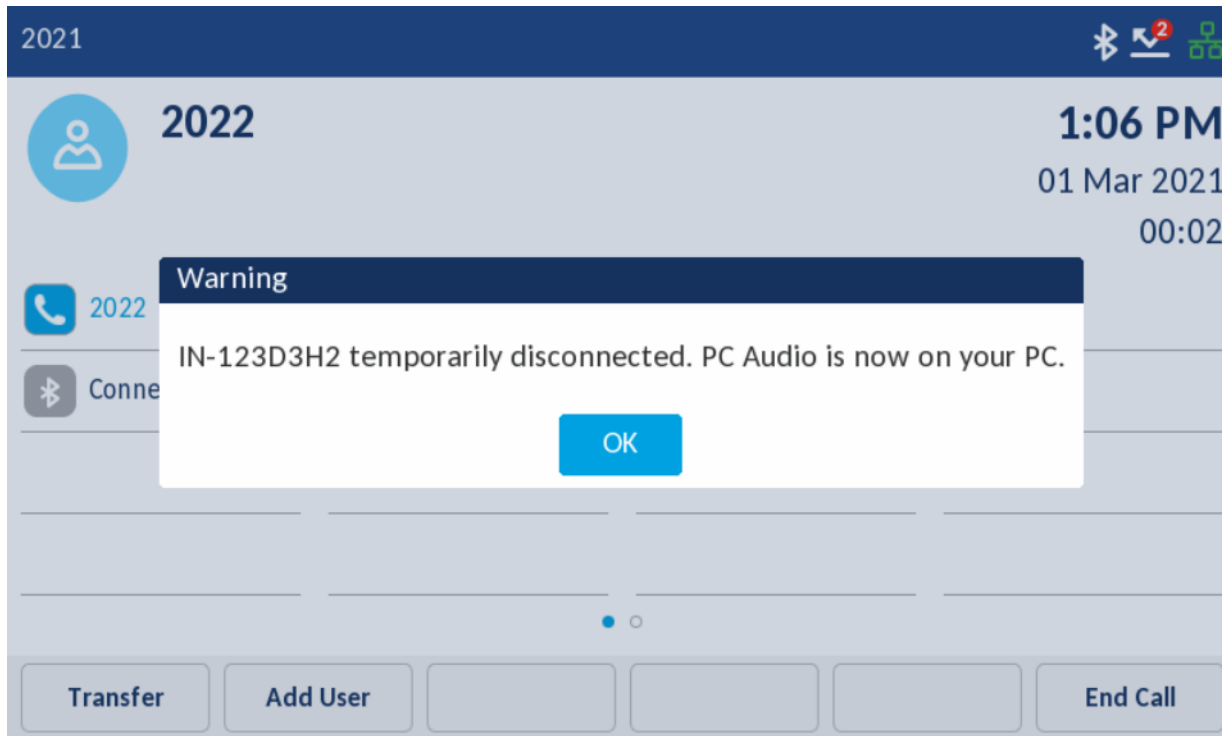

- When the user hangs up the IP call, the 6940 IP Phone will re-establish the connection with the PC after a couple of seconds.
- To use the handset to answer an IP call, the user must first tap the flashing IP Line key and then lift the handset from its cradle.
- If the user terminates the IP call by going back on-hook on the handset, the 6940 IP Phone will re-establish the connection with the PC after a couple of seconds.

When the IP Phone is Idle or Ringing

- If the user starts a PCLink session (that is, the user starts a PC application that has the phone set as the audio device) while the IP Phone is idle or ringing, then PC audio will automatically become active on the IP phone's speakerphone. The user can then change the audio path to an attached USB/ Analog headset by pressing the Speaker/Headset key (or the answer key on the headset) or to a wired handset by lifting the handset from its cradle.

When the IP Phone is on an active VoIP Call

- If the user starts a PCLink session (that is, the user starts a PC application that has the phone set as the audio device) while on an IP call on the phone, the Mobile/PC Line key starts flashing and the button label changes to **PC Audio**:
 - If the user hangs up the IP call at some point after initiating the PCLink audio, the user must press the Mobile/PC Line softkey on the phone to start the PCLink audio on the IP Phone's speakerphone. The user can then change to headset or handset as required.
 - If the user taps the Mobile/PC Line key to initiate the PCLink audio on the phone without first terminating the IP call, the IP call is put on hold. The PCLink audio automatically becomes active on whatever audio accessory the user was using for the IP call, which could be the speakerphone, headset, or corded handset. The user can switch between the PCLink audio and the IP Phone call audio by pressing the IP Line key or the Mobile/PC Line key.

When the IP Phone is in a DND or Locked State

- If the user places a desk phone call while the IP Phone is in DND or Locked state, the call fails.
- If the user initiates DND or locks the phone while the phone is already in use for PC audio, the PC audio remains active on the IP Phone regardless of the IP Phone being placed into DND or being locked.

Known Issues With Tested Video Collaboration Applications

Mitel has tested the PCLink feature with a number of third party Video Collaboration applications and has identified issues with use of the PCLink feature with some of them. Following is a description of the issues and recommendations for how to use these applications to avoid these issues.

Microsoft (MS) Teams

While using PCLink for a web browser accessed MS Teams meeting, if you switch to an IP Phone call on the phone and then switch back to the PCLink audio, the browser based MS Teams session does not automatically set the PC audio device it is using back to the 6940 IP Phone. You will need to manually select the 6940 IP Phone as the audio device from within the MS Teams Audio Settings. To avoid this issue, it is recommended that you use the MS Teams PC application to host/access MS Team meetings, which must first be downloaded and installed on your PC.

GoToMeeting

In testing GotoMeeting, random 1-way audio issues were encountered for the meeting host only that is, the host can hear others but no-one can hear the host. However, no issues were seen with meeting participants using PCLink for the meeting audio. To avoid this issue, it is recommended that you switch to a PC audio device other than the Mitel 6940 IP Phone from within the GotoMeeting Audio Settings when hosting a session. If you are a meeting participant, there is no issue with using the Mitel 6940 IP Phone as the audio device for GotoMeeting sessions.

Google Workspace (GSuite/Google Meet)





When hosting or accessing a Google Workspace meeting using a web browser other than Google Chrome, Google Workspace automatically selects the Operating System (Windows 10/ MAC OS) default audio device as the Speaker to use and it is not possible to change this to a different audio device within the Workspace Audio Settings. To overcome this, you can set the Mitel 6940 IP Phone as the default audio device within the PC OS, however, this is not recommended. To avoid this issue, it is recommended that you host or access Google Workspace meetings using the Google Chrome browser.







Additional features





The following features are available using feature keys only if your System Administrator has defined a programmable key or softkey with the respective functionality on your phone.



When configured on a programmable key, icons are displayed beside the label indicating type of functionality. When a generic ON/OFF icon or a custom ON/OFF icon (such as those displayed for DND, Make Busy, Phone Lock, Call Fwd Always, Night Service, and Record a Call) is displayed, the key acts as a toggle to enable and disable the respective feature. If no icon is displayed beside the key's label, the feature either requires user input or is used to convey information.



For detailed information on how to use any of the following features, please contact your System Administrator.



Feature	Description	Icons	Type
Account Code NonVerified	Non-verified Account Codes let you enter codes on the SMDR record for billing and/or call management.		Non-Toggle
Account Code Verified	Verified Account Codes let you access features that are not normally available at a station. You enter Verified Account Codes before making a call to change the COS and COR at any station. When you hang up, the station returns to normal.		Non-Toggle
ACD	Automatic Call Distribution (ACD) functionality allows call centers to process incoming calls based on a number of customizable parameters.		Non-Toggle
Auto Answer	Auto-Answer lets you automatically answer calls that ring your Prime line.		Toggle ON/OFF



Feature	Description	Icons	Type
Call Fwd Always	Call Fwd Always is used to redirect all incoming calls to an alternate number.		Toggle ON/OFF
Call Fwd Busy	Call Fwd Busy is used to redirect both incoming internal and external calls to an alternate number when your phone is busy.		Toggle ON/OFF
Call Fwd Busy External	Call Fwd Busy External is used to redirect incoming external calls to an alternate number when your phone is busy.		Toggle ON/OFF
Call Fwd Busy Internal	Call Fwd Busy Internal is used to redirect incoming internal calls to an alternate number when your phone is busy.		Toggle ON/OFF
Call Fwd No Ans. External	Call Fwd No Ans. External is used to redirect incoming external calls to an alternate number when you do not answer.		Toggle ON/OFF
Call Fwd No Ans. Internal	Call Fwd No Ans. Internal is used to redirect incoming internal calls to an alternate number when you do not answer.		Toggle ON/OFF
Call Fwd No Answer	Call Fwd No Answer is used to redirect both incoming internal and external calls to an alternate number when you do not answer.		Toggle ON/OFF



Feature	Description	Icons	Type
Call Park and Call Park - Retrieve	Call Park allows you to place a call in a special hold state. You, or someone else, can then retrieve the call from another extension in the system by pressing the Call Park - Retrieve key.		Toggle ON/OFF
Call Pickup	Call Pickup lets you answer a call that is ringing at another station, including an attendant console.		Toggle ON/OFF
CDE Speedcall	This feature allows you to speed dial telephone numbers that the administrator has programmed into the system.	Avatar	Non-Toggle
Direct Page	Direct Page allows you to page another telephone over its built-in speaker, even if the telephone is in use.		Toggle ON/OFF
Do Not Disturb	Do Not Disturb (DND) stops internal calls from ringing on your phone and returns busy tone to the caller. DND does not stop external calls from ringing nor does it affect your ability to make calls.		Toggle ON/OFF
DSS/Busy Lamp	You can use the Busy Lamp Field feature to monitor the status of single-line sets, single-member lines, key system lines, multicall Broadcast Groups, and Hot Desk users.	Line States	Non-Toggle



Feature	Description	Icons	Type
Emergency Call	<p>The Emergency Call Notification key allows you receive emergency call notifications. Pressing the key allows you to view the caller's directory number, special instructions that are programmed for the DN in the Comments field of the CESID Assignment form, and the date and time of the call.</p>		Toggle ON/OFF
Float Keys	<p>Float keys are typically used to display unanswered ringing lines on designated keys where the ringing lines would otherwise be hidden on one of the phone's application pages.</p>	Line States	Non-Toggle
Group Listen	<p>With Group Listen, you can carry on a conversation using the handset or headset while allowing others nearby to listen to the person at the far end over the handsfree speaker.</p>		Toggle ON/OFF



Feature	Description	Icons	Type
Group Park	Group Park allows you to place a call in a special hold state. You, or someone else, can then retrieve the call from another extension in the system. Group Park uses a single feature key to both park and retrieve calls. Any telephone programmed with the same Group Park key can retrieve the call.		Toggle ON/OFF
Group Presence	Group Presence allows members of call groups (Hunt, ACD, Ring, Personal Ring, and Multi-device User) to make themselves absent or present in a group. Only members who are present in a group are offered calls to that group.		Toggle ON/OFF
Handoff	The Handoff feature for Personal Ring Groups (PRGs) allows calls to be "Pushed" or "Pulled" between group member devices. A Push passes the call to the group, where it can be answered by any other present group device. A Pull takes an in-progress call away from another member.		Toggle ON/OFF

Feature	Description	Icons	Type
Key System	Key System Groups let multiple telephones share the same extension number. Incoming calls ring all of the idle stations, and the stations stop ringing when one member answers the call. Only one member of a Key System Group can use the line at one time.	Line States	Non-Toggle
Make Busy	The Make Busy feature ensures an ACD extension does not receive ACD calls when the agent is unavailable. The ACD extension remains in the Make Busy state until an agent deactivates it.		Toggle ON/OFF
Meet Me Answer	Meet-Me Answer lets you respond to a Group Page that you missed, even if you do not know the identity or location of the person that paged you.		Non-Toggle
Message Waiting Indication	Keys can be programmed as message waiting indicators which are associated with the mailboxes of other stations. The indicator flashes when a message is waiting in the associated mailbox. This allows you to look at the phone and recognize which mailboxes have messages.		Toggle ON/OFF

Feature	Description	Icons	Type
Multicall	<p>Multicall Groups let multiple telephones share the same extension number. Incoming calls ring all of the idle stations, and the stations stop ringing when one member answers the call. A Multicall group allows more than one group member to use the line at the same time.</p>	Line States	Non-Toggle
Night Answer	<p>Night Answer lets you send your calls to another location when the system is in Night Service.</p>		Toggle ON/OFF
Night Service Indication	<p>Night Service switches the system from day service to night service and vice versa. When the system is placed into night service (usually at the end of the workday) incoming external calls ring at an extension(s) selected by the Administrator.</p>		Toggle ON/OFF

Feature	Description	Icons	Type
Paging	Paging lets you connect to loudspeaker or paging equipment to make an announcement. You can access individual paging zones or all paging zones simultaneously. A one-way connection is established for "All Zones" paging. A two-way connection is established for "Individual Zones" loudspeaker page.		Toggle ON/OFF
Personal Presence	Personal Presence lets you choose which of your personal answer points you want to receive your calls at.		Toggle ON/OFF
Phone Lock	The Phone Lock feature locks a set, preventing access to the majority of features, with the following exceptions: unlocking the set via a user PIN, Hot Desk Login and Logout support, and Emergency Call Notification support. Phone Lock has no effect on incoming calls but restricts outgoing calls, with the following exceptions: calls to emergency trunk routes and local operators.		Toggle ON/OFF

Feature	Description	Icons	Type
Privacy Release	Privacy Release allows members of a Key System Group to disable automatic call privacy protection to allow another member of the group to join the call. When a new member enters the call the original members receive a conference tone and the privacy feature is restored.		Toggle ON/OFF
Record a Call	Record-a-Call (RAC) allows extension users to record a two-party call when one party is connected to a trunk. The recorded conversation is stored in the users' voice mail mailbox.		Toggle ON/OFF (and Pause)
Secretarial	A DSS key provisioned with the "secretarial" option allows you to perform a transfer to the associated device or directory number.	Line States	Non-Toggle
Single Line	The Single Line feature is used to set the prime line as a single line, whereby it is dedicated to one phone only.	Line States	Non-Toggle

Feature	Description	Icons	Type
Specific Group Alert	A Specific Group Alert key normally appears only on an ACD supervisor's telephone. Each Specific Group Alert key allows the supervisor to obtain queue status information for a specific agent skill group. A supervisor's telephone may have several Specific Group Alert keys.		Non-Toggle
Superkey	Superkey programming allows for easy access to telephone system features and feature-set customization.		Non-Toggle
Tag Call	Tag Call allows phone users to signal that they are the victim of a malicious call. This Malicious Call Indication is logged as an SMDR record.		Non-Toggle
User Speedcall	User Speedcall keys allow you to store external numbers under feature keys for faster dialing. You can press a Speed Call Key to dial a phone number or, during a call, to outpulse DTMF tones.	Avatar	Non-Toggle
User Speedcall - Private	A private User Speedcall is a User Speedcall that is considered private, whereby Caller ID information is not displayed in the phone's call history.	Avatar	Non-Toggle

Accessory support

Mitel M695 Programmable Key Module (PKM)

Up to three Mitel M695 PKMs can be attached to the right of the Mitel MiVoice 6940 IP phone providing you with 84 additional programmable keys (28 keys per PKM).

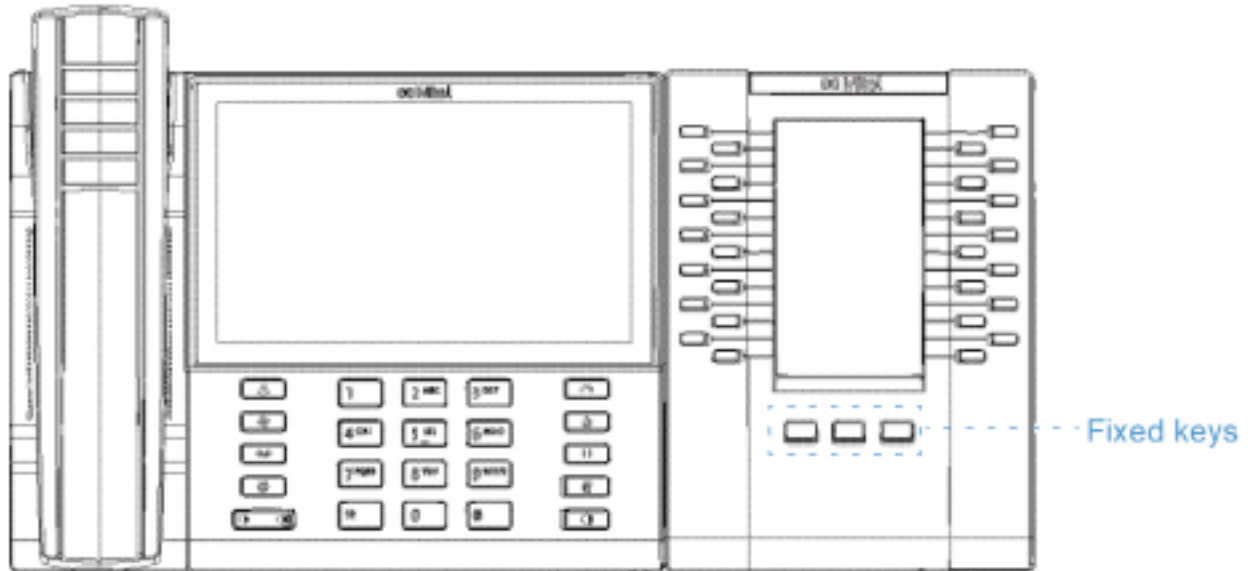

The Mitel M695 PKM features a 4.3" 480x272 pixel color backlit LCD display that provides a unified graphical user experience with the Mitel MiVoice 6940 IP phone.

The Mitel M695 PKM supports the same programmable key functions as the Mitel MiVoice 6940 IP phone. The programmable keys can only be programmed by your System Administrator.

NOTE:

1. The fixed keys on the Mitel M695 PKM are supported on the Mitel MiVoice Business System.
2. Use a IEEE 802.3at compliant PoE L2 Switch, IEEE 802.2at Inline Power Injector, or an AC to DC Adapter to power the Mitel MiVoice 6940 IP phone.
3. For information how to install your Mitel M695 PKM, see the *Mitel M695 PKM Installation Guide*.

The Mitel MiVoice 6940 IP phone supports up to 3 pages on the PKM.

The following describes the PKM behavior for multipage support:

1. When one PKM with three pages is attached to the IP phone -
 - a. The PKM displays all the three pages.
2. When two PKMs with 3 pages are attached to the IP phone -
 - a. The first PKM displays Page 1 where Page 2 and Page 3 are blank.
 - b. The second PKM displays Page 1 and Page 2 where Page 3 is blank.

3. When three PKMs with 3 pages are attached to the IP phone -
 - a. The first PKM displays Page 1 where Page 2 and Page 3 are blank.
 - b. The second PKM displays Page 1 where Page 2 and Page 3 are blank.
 - c. The third PKM displays Page 1 where Page 2 and Page 3 are blank.

NOTE:

1. Similar PKM behavior is observed when 1 and 2 pages are programmed.
2. Handling of PKM key press on blank page is ignored on the IP Phone.
3. The corresponding page LED turns solid when user presses the PKM page keys.

The following describes the LED behavior for the PKM page keys:

1. If there is a ringing line programmed on the second PKM page and the first PKM page is active then the LED for the second PKM page blinks.
2. The page LED turns off when the screen saver is activated on the PKM.

Mitel Wireless LAN Adapter

The Mitel Wireless LAN Adapter is a wireless bridge that can add wireless connectivity functionality to your Mitel MiVoice 6940 IP phone. It allows your Ethernet-enabled phone to join a secure, high-speed network. It is software transparent meaning no changes to drivers, management tools, or applications are needed.



Feature highlights include:

- **Easily add robust, secure wireless capabilities to Ethernet devices:**
The Mitel Wireless LAN Adapter is a high-performance wireless network adapter which enables any Ethernet device to become an 802.11a/b/g/n dual band wireless network device, giving you freedom to place it anywhere in your facility.
- **Dual band IEEE 802.11a/b/g/n support:**
The Mitel Wireless LAN Adapter is designed to communicate in the 2.4 GHz and 5 GHz bands. Radio interference in the commonly used 2.4 GHz band can be avoided by utilizing 5 GHz.
- **Gigabit Ethernet support:**
The wired LAN port supports 10/100/1000BASE-T (auto-recognition).

- **Simple to setup and use:**
The Mitel Wireless LAN Adapter is easy to set up using the enclosed network setup cable. No special drivers or software are required.
- **Enterprise security:**
The Mitel Wireless LAN Adapter supports the following security functions:
 - WEP (64 Bit/128 Bit)
 - WPA-PSK (TKIP/AES)
 - WPA2-PSK (AES)
 - IEEE 802.1X EAP-PEAP, EAP-TLS, EAP-TTLS, EAP-FAST, EAP-LEAP

NOTE: For information how to install and set up your Mitel Wireless LAN Adapter, see the *Mitel Wireless LAN Adapter Setup Guide*.

Mitel Cordless Bluetooth Handset

The Mitel MiVoice 6940 IP phone provides support for the Mitel cordless Bluetooth handset. With a potential range of up to 10 meters (30 feet), the Bluetooth handset offers convenience and corridor mobility for Mitel MiVoice 6940 IP phone users.

Feature highlights include:

- Hookswitch (Initiate call/end call) key
- Volume control keys
- Mute key
- Built-in handset ringer
- LED indicators to indicate both connectivity and charging status
- At least six hours talk time
- Over 40 hours standby time
- Handset battery recharge time of three hours or less
- Wideband audio capable

NOTE:

1. To pair the handset with the Mitel MiVoice 6940 IP phone, power on the handset and follow the procedures detailed in [“Pairing a Bluetooth device”](#). The device name will appear in the available devices list as "Cordless Handset" followed by the last six digits of the handset's MAC address.
2. For information how to set up your Bluetooth handset, see the *Mitel Cordless Bluetooth Handset Quick Start Guide*.

Hardware features

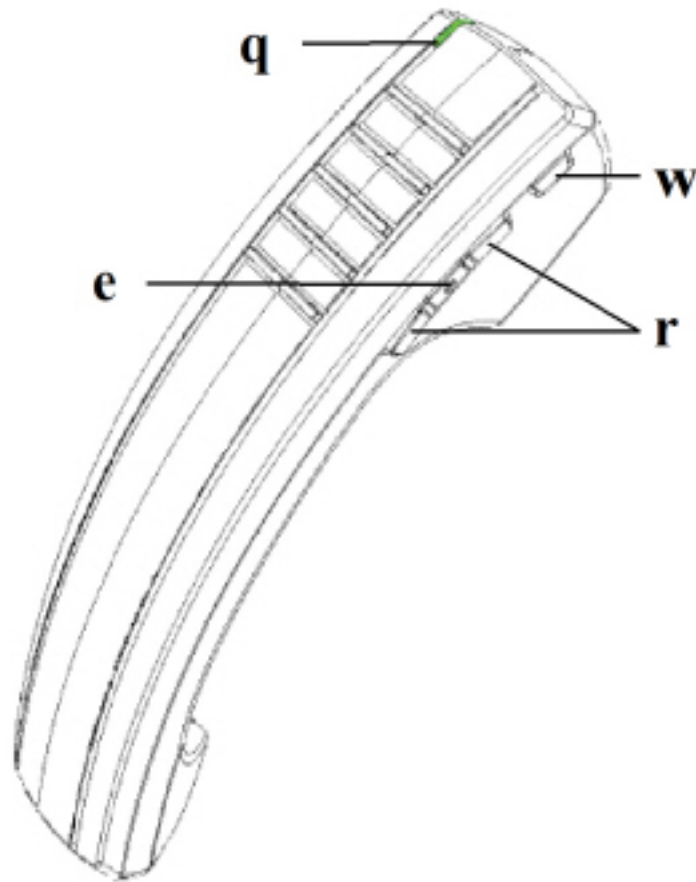

Number	Feature	Description
q	LED	Blue - Indicates the status of the handset. Green - Indicates the status of the handset battery. For more information, see “LED indicator” .

Number	Feature	Description
w	Hookswitch key	Lifting the handset from the cradle activates the handset. If the handset is already out of the cradle, pressing the Hookswitch key is equivalent to taking the handset off hook. Pressing the key again is equivalent to placing the handset on hook. Pressing the Hookswitch key while on a speakerphone call moves the call to the cordless handset.
e	Mute key	Mutes the handset microphone so that your caller cannot hear you. For more information, see “Muting the microphone” .
r	Volume controls	Adjusts the volume for the handset. Press the key above the Mute key to increase the volume and press the key below the mute key to decrease the volume.

LED indicator

The cordless Bluetooth handset has two LEDs:

- Blue – indicates the operational status of the handset.
- Green – indicates the status of the electrical charge of the battery.

LED color, states, and indicator descriptions are as follows:

LED Color	LED State	Indicates
Blue (Handset Not in Cradle)	Blinking	Handset is not connected and is in pairing mode.
	Winking	Handset is connected but not in use.
	Fading	Handset is connected and in use.

LED Color	LED State	Indicates
Green (Handset in Cradle)	Solid	Battery is fully charged.
	Winking	Battery is charging. NOTE: It is normal for the handset LED to cycle between winking and solid as battery charge is maintained.
	Off	When handset is cradled and the LED does not flash or illuminate, this indicates an absence of battery power. During the first 30 – 60 minutes that the light is off, the battery may be trickle charging. If that is the case, the LED will resume normal behavior within that 60 minute period. If the LED remains off for more than 60 minutes, then either the battery is no longer chargeable or there is a problem in the charging circuit.

NOTE:

1. Blinking denotes the LED is alternating very quickly between on and off.
2. Winking denotes the LED is alternating between being on for a short period of time and then off for a longer period of time.
3. Fading denotes the LED is alternating between fading in and out.

Alerting tones

The handset provides the following alerting tones:

Event	Tone
Power OFF	Four tones successively decreasing in pitch.
Mute key on handset ON	Two low pitched tones

Powering on/off the Bluetooth cordless handset

To power on the Bluetooth cordless handset place the handset on the IP phone's cradle.

To power off the Bluetooth cordless handset, press the **Hookswitch** key for approximately six seconds until the LED indicator turns blue and then turns completely off.

Mitel Integrated DECT Headset

The Mitel Integrated DECT Headset is a professional wireless headset designed for maximum performance.

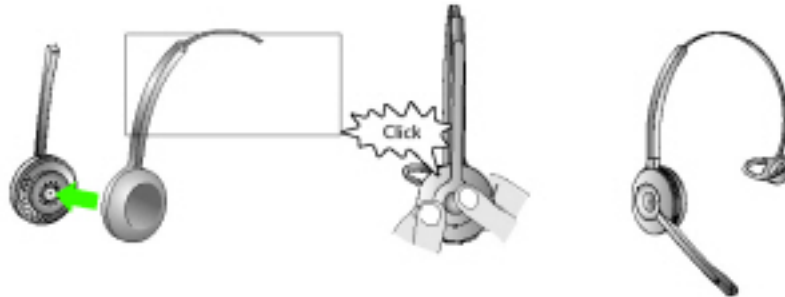

The Mitel Integrated DECT Headset is compatible with Mitel MiVoice 6940 IP phone. The Mitel Integrated DECT Headset is also compatible with the Mitel M695 Programmable Key Module, supporting up to three modules connected to your 6940 IP phone.

NOTE:

1. Before connecting the Mitel Integrated Headset to Mitel MiVoice 6940 IP phone, ensure to disconnect (unpair) other headsets.
2. Use a IEEE 802.3at compliant PoE L2 Switch, IEEE 802.2at Inline Power Injector, or an AC to DC Adapter to power the Mitel MiVoice 6940 IP phone when connecting the Mitel Integrated DECT Headset to a Mitel M695 Programmable Key Module.

Features

- Wideband audio for exceptional sound quality.
- Volume and mute controls.
- Intuitive headset multi-function button for easy call handling.
- LED and audio indicators.
- Advanced hearing protection.
- Noise-canceling microphone.
- Up to 8 hours battery life.
- Headset recharge docking cradle.
- Visual and audio call status indicators.
- Battery indicator.

Using the headset

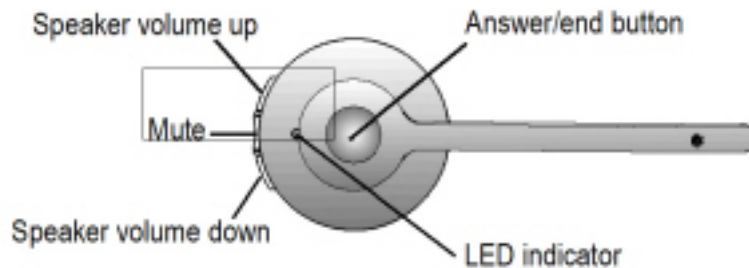

Charging the headset

To charge the headset, dock the headset in the base. When docked correctly the headset battery will begin charging.

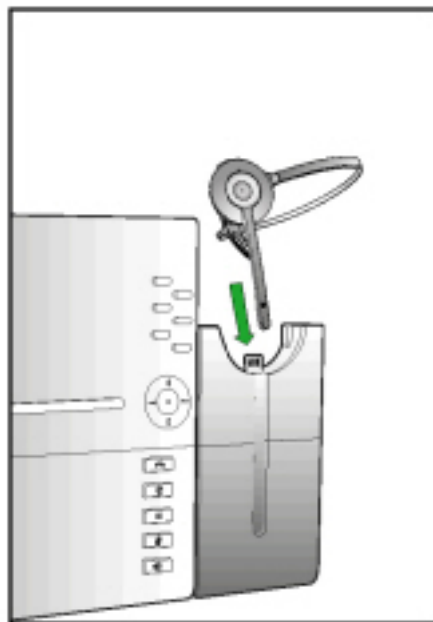

When fully charged, the headset offers up to 8 hours of talk time.

Upgrading the headset

To upgrade the headset firmware, dock the headset in the base and reboot the Mitel MiVoice 6940 IP phone.

NOTE: For the headset firmware upgrade, the battery level of the Integrated DECT Headset must be at 20% at least.

Check the battery level and firmware version of the Integrated DECT Headset

1. Press the  (**Settings**) key to enter the **Settings** menu.

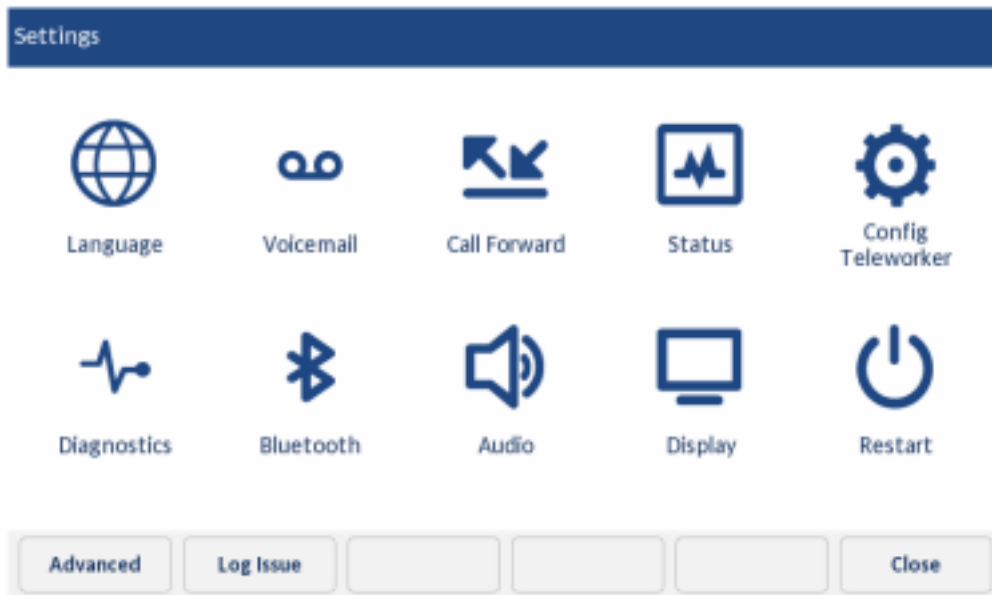





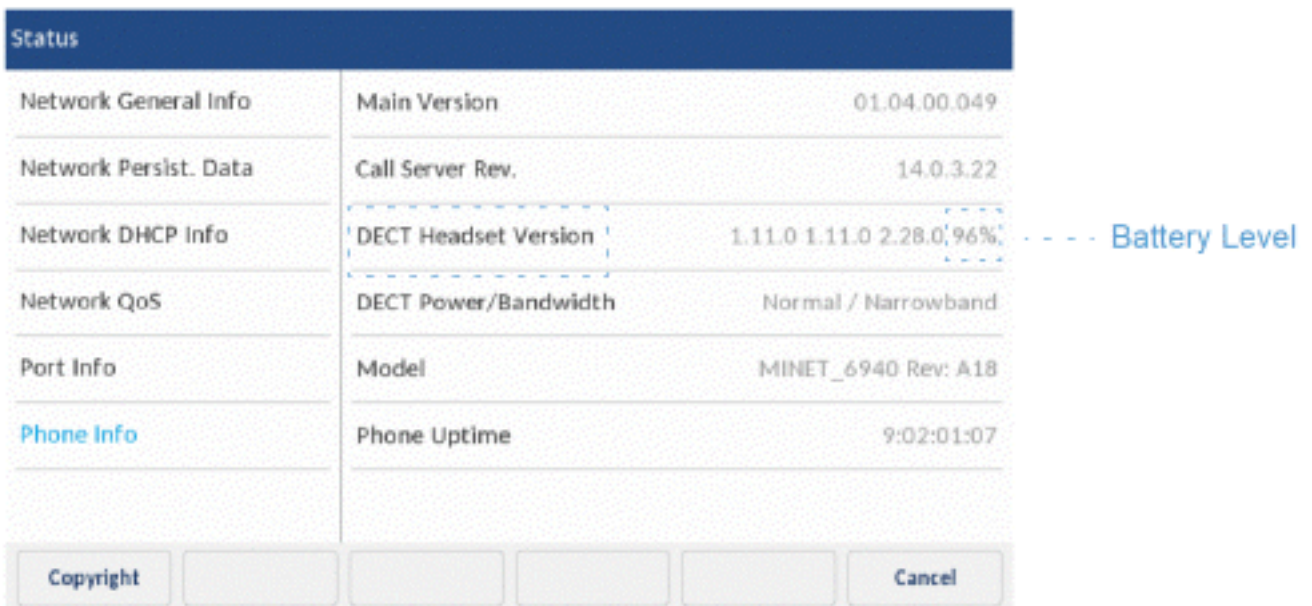



2. Tap the **Status** icon.
3. Tap the **Phone Info** status category.

The firmware version, battery level, and Power/Bandwidth info of the Integrated DECT Headset is available on the screen.



LED status

LED indicator	Description
	Battery charging (Green - slow flash)
	Full battery (Green)
	Medium battery (Yellow)
	Low battery (Red)
	Very low battery (Red - flashing)
	Unknown battery status (White)
	Microphone muted
	Active audio between headset and base
	Searching for headset (flashing)

NOTE: For how to install the Mitel DECT Headset to your 6940 IP phone or the Mitel M695 Programmable Key Module, see the *Mitel Integrated DECT Headset Installation Guide*.

Replacing the Integrated DECT Headset

If the Integrated DECT Headset is malfunctioning, or if you have paired a wrong Integrated DECT Headset with the base, you must replace and repair the Integrated DECT Headset.

To replace and repair the Integrated DECT Headset:

1. Remove the headset from the base.
2. Turn off the headset by pressing the **Answer/end** button for 10 seconds until the LED indicator stops flashing.

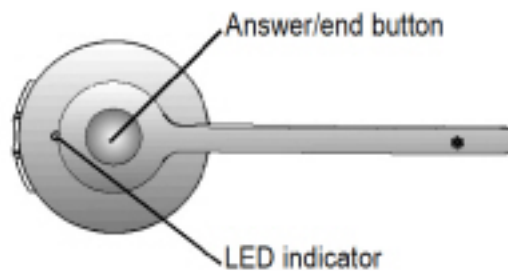

3. Dock the new headset in the base. The new headset is paired with the base after 1 minute.

Mitel S720 Bluetooth Speakerphone







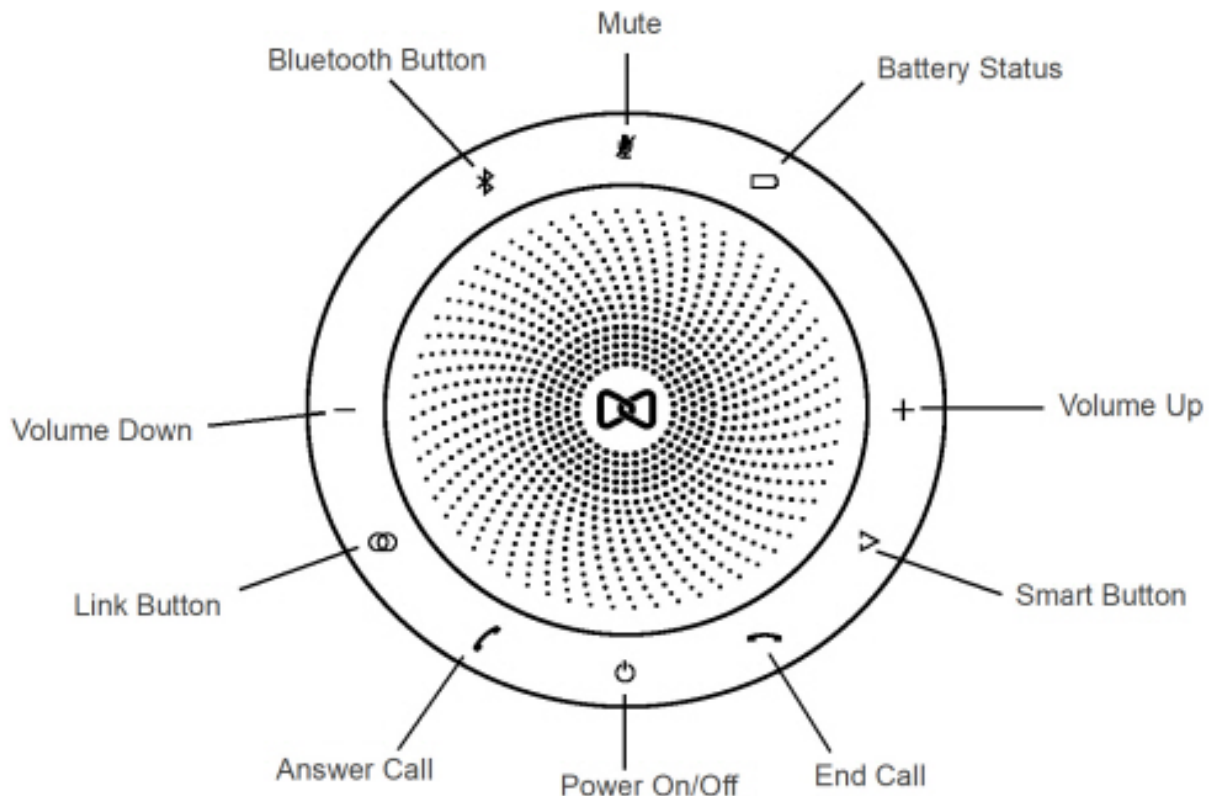

The Mitel S720 Bluetooth Speakerphone is supported with the Mitel MiVoice 6940 IP phone that allows you to instantly transform any room into a conference room. You can easily connect and enjoy the crystal clear HD audio, while maximizing productivity during conference calls through this premium portable and easy-to-use Bluetooth speakerphone.

Feature highlights include:

- HD voice audio
- Omni directional microphone
- Functionally integrated with desk phone - volume / mute sync, pulling call to / from conference phone
- Connect two speakerphones wirelessly to extend speakerphone range and for stereo music playback
- Play smartphone audio from mobile with auto pause when incoming call to desk phone
- Intuitive connectivity through Bluetooth®
- Portable design, protective travel pouch, and battery powered with USB charging (15 hours of talk time)
- Flexible and scalable for office side tables and small meeting rooms

Hardware features





Icon	Button	Description
	Power On/Off	Turns on or off.
	Answer Call	Answers a call.
	End Call	Ends or rejects a call. Hold (8 seconds) to turn on or off voice guidance.
	Volume Up and Volume Down	Increases or decreases the volume.
	Mute	Mutes the microphone.
	Battery Status	Shows the battery status.
	Bluetooth	Connects to a Bluetooth device.
	Link	Links two speakerphones.
	Smart	Turns on or off the voice assistant application on your smartphone.

NOTE:

1. To pair the Mitel S720 Bluetooth Speakerphone with the Mitel MiVoice 6940 IP phone, power on the speakerphone and follow the procedures detailed in ["Pairing a Bluetooth device"](#). The device name will appear in the available devices list as "S720 Bluetooth Speakerphone". When the speakerphone

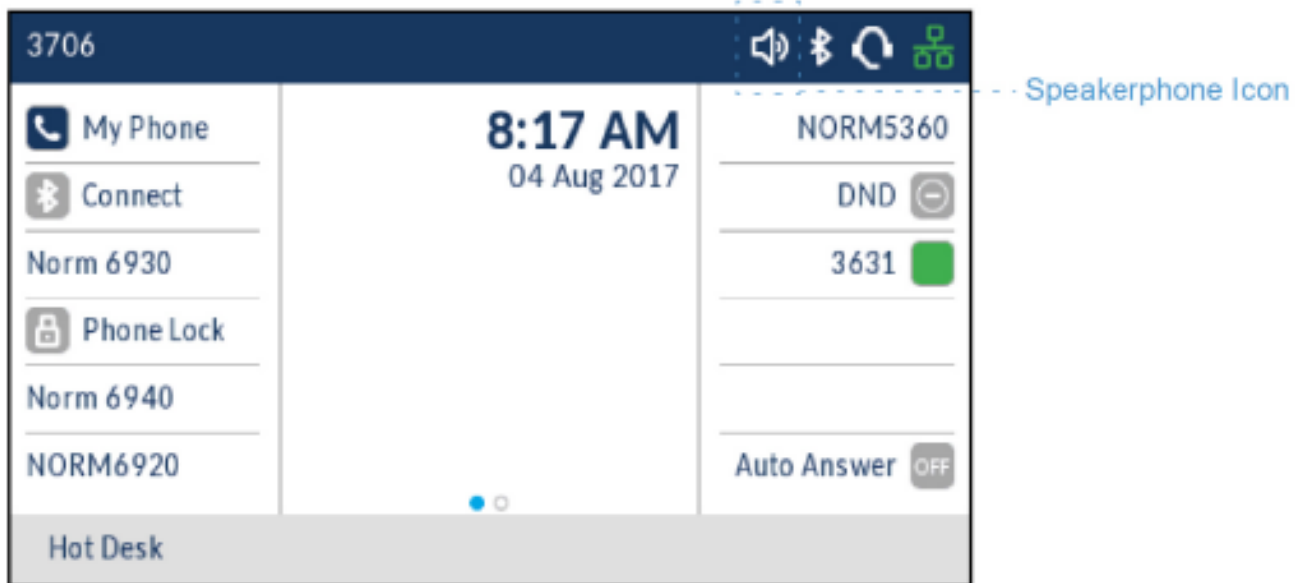
is successfully connected, a speakerphone connected icon  is displayed in the status bar on the Home screen.



2. If you have paired and connected your smartphone to your Mitel MiVoice 6940 IP phone, your smartphone will temporarily disconnect from the IP phone while you have a call active on the Mitel S720 Bluetooth Speakerphone. The IP phone will automatically reconnect your smartphone once the call has been terminated.
3. The  (**Speaker/Headset**) key LED on the IP phone will remain unlit when the call audio is presented on the speakerphone.
4. For information how to set up your Mitel S720 Bluetooth Speakerphone, see the *Mitel S720 Bluetooth Speakerphone Installation Guide*.

USB headsets

The Mitel MiVoice 6940 IP phone accepts USB headsets through the USB port on the back of the phone.

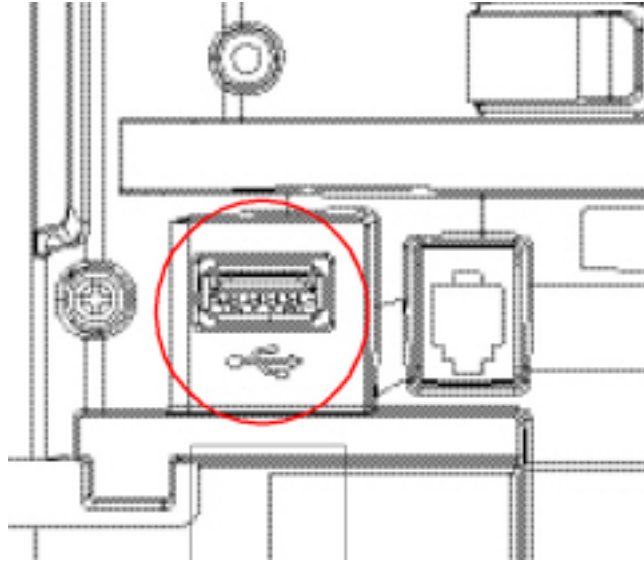

Contact your telephone equipment retailer or distributor to purchase a compatible headset.

NOTE:

1. Customers should read and observe all safety recommendations contained in headset operating guides when using any headset.
2. Contact your System Administrator for questions regarding supported headsets or refer to the *MiVoice Business Release 8.0 Release Notes*.
3. Headsets connected to the Mitel MiVoice 6940 IP phone are limited in functionality to answering, ending, and muting calls. Additional headset features (such as rejecting calls) are not supported and will cause unexpected behavior (e.g. invoking the reject call function will answer instead of reject).
4. If both a USB headset and a Bluetooth headset are connected to the phone the Bluetooth headset will take precedence over the USB headset.

To make and receive calls using a headset:

1. Ensure that you have selected the **Headset** audio path (see [“Audio Path”](#)).
2. Turn the phone over and, depending on the type of headset, locate the headset jack marked for the USB port.
3. Insert the headset’s USB plug into the USB port.

NOTE: See the *Mitel MiVoice 6940 IP Phone Installation Guide* for more information.

Limited warranty

Mitel warrants this product against defects and malfunctions in accordance with Mitel's authorized, written functional specification relating to such products during a one (1) year period from the date of original purchase ("Warranty Period"). If there is a defect or malfunction, Mitel shall, at its option, and as the exclusive remedy, either repair or replace the product at no charge, if returned within the Warranty Period. If replacement parts are used in making repairs, these parts may be refurbished, or may contain refurbished materials. If it is necessary to replace the product, it may be replaced with a refurbished product of the same design and color. If it should become necessary to repair or replace a defective or malfunctioning product under this warranty, the provisions of this warranty shall apply to the repaired or replaced product until the expiration of ninety (90) days from the date of pick up, or the date of shipment to you, of the repaired or replacement product, or until the end of the original Warranty Period, whichever is later. Proof of the original purchase date is to be provided with all products returned for warranty repairs.

Exclusions

Mitel does not warrant its products to be compatible with the equipment of any particular telephone company. This warranty does not extend to damage to products resulting from improper installation or operation, alteration, accident, neglect, abuse, misuse, fire or natural causes such as storms or floods, after the product is in your possession. Mitel will not accept liability for any damages and/or long distance charges, which result from unauthorized and/or unlawful use.

Mitel shall not be liable for any incidental or consequential damages, including, but not limited to, loss, damage or expense directly or indirectly arising from the customer's use of or inability to use this product, either separately or in combination with other equipment. This paragraph, however, shall not apply to consequential damages for injury to the person in the case of products used or bought for use primarily for personal, family or household purposes.

This warranty sets forth the entire liability and obligations of Mitel with respect to breach of warranty, and the warranties set forth or limited herein are the sole warranties and are in lieu of all other warranties, expressed or implied, including warranties or fitness for particular purpose and merchantability.

Warranty repair services

Should the product fail during the Warranty Period;

- **In North America**, please call 1-800-574-1611 for further information.
- **Outside North America**, contact your sales representative for return instructions.

You will be responsible for shipping charges, if any. When you return this product for warranty service, you must present proof of purchase.

After warranty service

Mitel offers ongoing repair and support for this product. This service provides repair or replacement of your Mitel product, at Mitel's option, for a fixed charge. You are responsible for all shipping charges. For further information and shipping instructions:

- **In North America**, contact our service information number: 1-800-574-1611.
- **Outside North America**, contact your sales representative.

NOTE: Repairs to this product may be made only by the manufacturer and its authorized agents, or by others who are legally authorized. This restriction applies during and after the Warranty Period. Unauthorized repair will void the warranty.

